

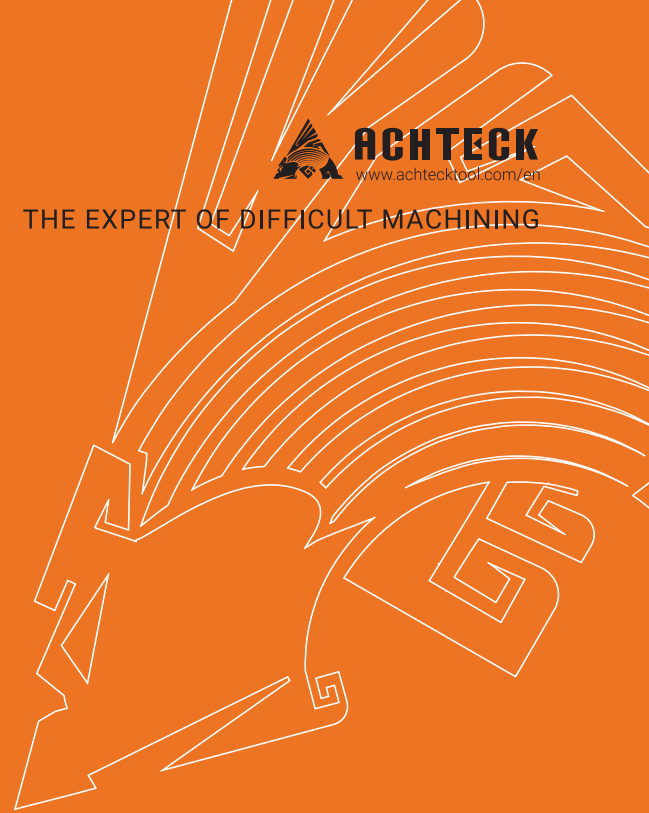

CUTTING TOOL CATALOGUE

2023





In the Northern depths, a wondrous sight,
A fish so vast, a true delight,
Named Kun, it spans a thousand miles,
A creature of immense style.

Transformed to Peng, a bird so rare,
Its wingspan vast, beyond compare,
Thousands of miles, it takes to flight,
A soaring wonder, a true delight.

When Peng takes flight, its rage is seen,
Its wings a sight, like clouds serene,
A sight that leaves us all in awe,
A vision of beauty, without a flaw.





Company Profile

Ganzhou Achteck Tool Technology Co., Ltd. is a wholly-owned subsidiary of Chongyi Zhangyuan Tungsten Co., Ltd. (Listed Company with stock code 002378). The registered capital of Achteck is 260 million USD with 700 employees. The main products include: Coated Carbide Inserts, Carbide Rod and supporting tool holders. Achteck is known for its outstanding R&D competence, production & testing equipment and its coated carbide insert production technology. Achteck produces inserts for Turning, Grooving, Milling and Drilling that are widely applied in automotive, energy, die & mold, general machinery, aerospace and other industries.

Achteck Tool is technology oriented, owns a strong research team that keeps on innovating. Having "Benefits from Resources, Reliance on Technologies, Devotion to Humanity and Top with Trust" as the operating philosophy and "Safety, Harmony, Efficiency and Innovation" as the target, Achteck aims to become a well-known brand in the world and a first-class cemented carbide manufacturer in China.

Small Tools



2023
NEW

Product Features and Applications

- Small tools has a wide range of product offering combined with many grades to meet the machining requests of different materials.
- Ground inserts with geometry UF and LF are good for high precision finishing and good chip breaking.
- Multifunction ASW series could combine with parting off, backturning and threading inserts for multipurpose machining to reduce the cost.
- Small Dia. solid carbide cutting tools can cover different machining, such as grooving, threading and small diameter boring.

Round Tools



Product Features and Applications

- Achteck has abundant solid carbide round tools including drills and end mills. Offering higher productivity and cost effectiviity to all the customers.
- Drills: D106/ D108 standard drills, diameter range from 3mm to 20mm; universal 3xDc to 8xDc solid carbide drills.
- End mills: ECO/PRO/XP solid carbide end mills are 3 product lines, from 2 cutting edges to 6 cutting edges, from round corner to waved edge, from univeral machining to dedicated machining. Solid carbide end mills have various product types.



Product Features and Applications

- Cermet inserts have high thermal conductivity, good chemical stability and toughness.
- AT202 grade is the 1st choice for general machining, is suitable for steel finishing and semi-finishing, has great performance at high-speed continuous machining and stable machining under poor machining condition.



Cermet Inserts

Grooving Inserts



Product Features and Applications

Double edged inserts

- Holder offering included external, internal, face grooving, turning and profile machining.
- Inserts width: 2-8mm
- Grooving and parting off geometries: CS, CM, CH
- Grooving and turning geometries: GS, TS, TM, RM, RA.
- High precision ground inserts are covering 1-8mm, can be used in parting, grooving and profile machining.
- Unique rake geometry design combined with double relief angle on the sides, obtained more clearance in face grooving and internal grooving, so that it could machine bigger diameter.

New! Triangular Insert

- Three types of insert: ATG32, ATG43, ASG32.
- Holder offering covers external grooving, internal grooving and profile machining.
- Insert width range: 0.33-4.8mm. More choices and good expansibility.
- High precision ground insert obtained excellent surface quality.



Product Features and Applications

- Positive square shoulder milling insert, three cutting edges, economical choice.
- Positive rake angle and spiral edge design, light cutting.
- Nose radius range: R0.8, R1.2, R1.6, R2.0, R2.4, R3.1, R4.0.
- Insert with short wiper, better surface quality.
- Pressed and ground insert choices for different machining precision requests.
- Wide application range: Used for square shoulder milling, face milling, slot milling, ramping, helical interpolate milling.
- Insert tip is protected due to the unique design.

ASM90-TD15 series

Square Shoulder Milling Tools



Product Features and Applications

- Cutter diameter range (Dc): Ø63- Ø250mm, both left and right hand tool body.
- Close and coarse pitch cutter design, with arbor coupling.
- Negative tangential insert, four left and four right hand cutting edges.
- E class peripheral ground insert, cutting edge with short wiper.
- Application range: Square shoulder milling and face milling; good surface finishing.
- Suitable for steel, stainless steel and cast iron rough and finish milling, good versatility.

ASM90-LN12 series

Square Shoulder Milling Tools

BS, SC1, SL3 New geometries for steel profile turning and stainless steel and heat resistant alloy turning.

ISO Turning Inserts

Features and Applications

BS Geometry

- Suitable for profile machining and corner turning.
- Good chip breaking and smooth chip evacuation in machining at low cutting depth.
- Keep constant chip evacuation in machining at various cutting depth.

SC1 Geometry

- Suitable for stainless steel and heat resistant alloy finish machining.
- Good chip control in machining at low feed and low cutting depth.
- Curved cutting edge reduced cutting force and built-up edge to obtain good surface quality and longer tool life.

SL3 Geometry

- Suitable for machining slender shaft, thin wall and unstably clamped parts.
- Guiding slot is good for precision cooling.
- Suitable for machining stainless steel and heat resistant alloy.

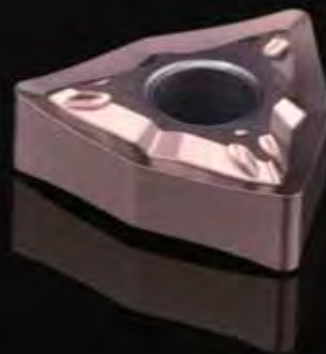



Features and Applications

- CVD coated grade.
- Excellent crater wear resistance and anti-plastic deformation.
- Used in steel high productivity medium and rough turning under stable conditions, high metal removal rate.
- Can withstand high temperature, and maintain good edge reliability under wet and dry machining condition.



AC052P High Productivity Turning Grade ISO Turning Inserts



AFM45-XN09-W milling cutter with heptagon inserts, extra close pitch with wedge clamping, combined with heat resistant CVD coated inserts. The ideal choice for cast iron rough milling.



APE90-LN09/LN13 porcupine milling tools in full teeth, high metal removal rate, reliable and safe milling environment.

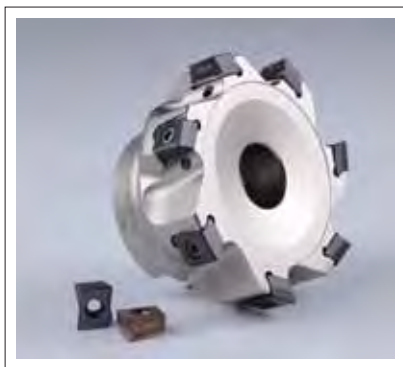

ASM90-LN09/LN13 square shoulder milling cutter with 4 cutting edge tangential inserts with helical edge profile. The reliable cutting edge can adopt 30% higher f_z , higher metal removal rate and productivity.

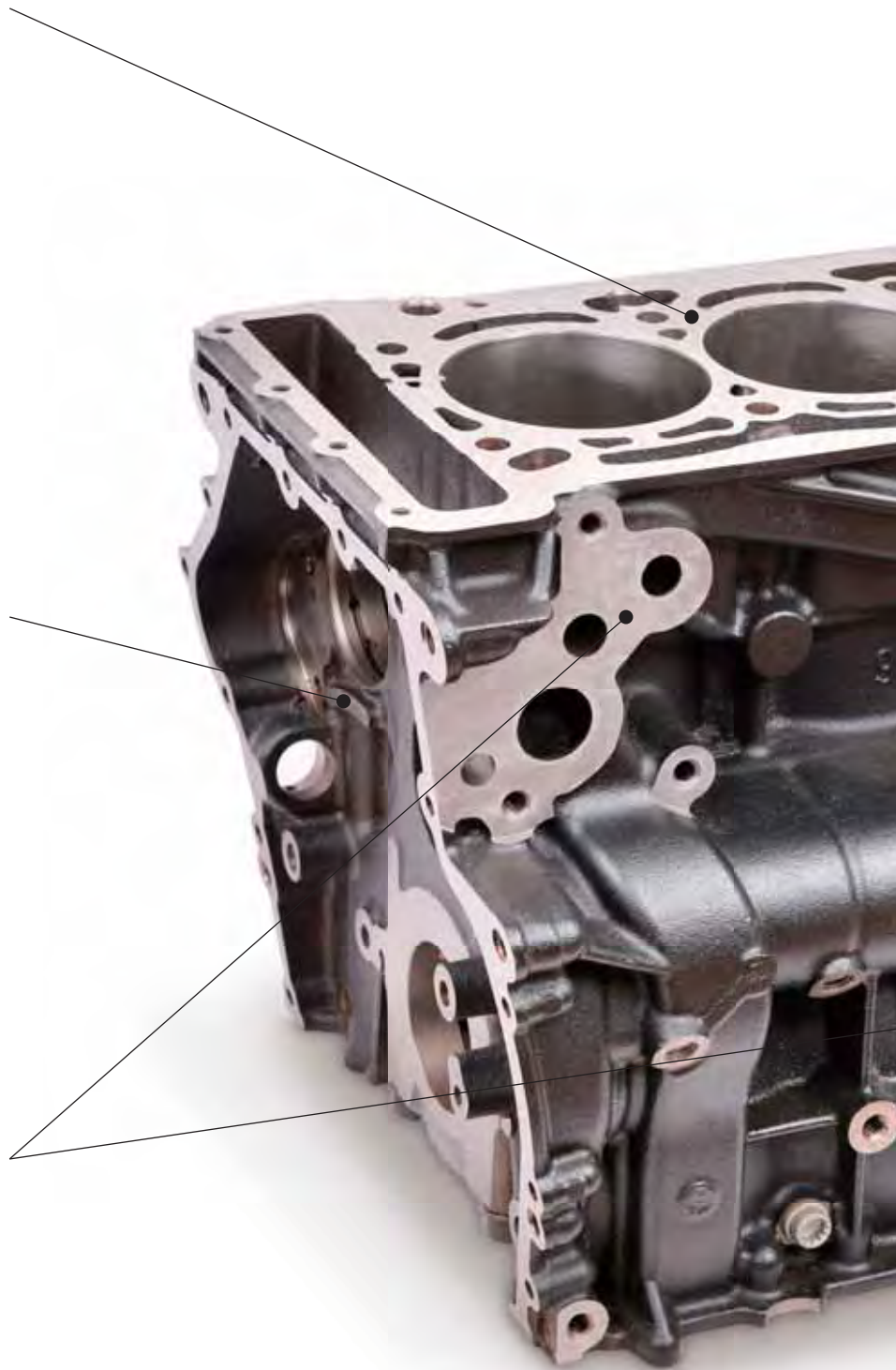



AFF0-LN15 cast iron finish milling cutter, combined with octagon main cutting inserts and wiper inserts. It's cost efficient and easy to handle. The good wear resistant grade and high precision cutting edge guaranteed excellent surface finishing and longer tool life.



D106 drill series, the substrate has both hardness and toughness, combined with high wear resistant PVD coating. It can reach higher tool life in cast iron machining. The unique drill tip geometry can reduce the edge chipping.

ACHTECK

www.achtecktool.com/en

Machining Solutions for Engine Block

Machining Solution for Turbocharger Housing



Special side face milling cutter is used in machining the back face of flange.

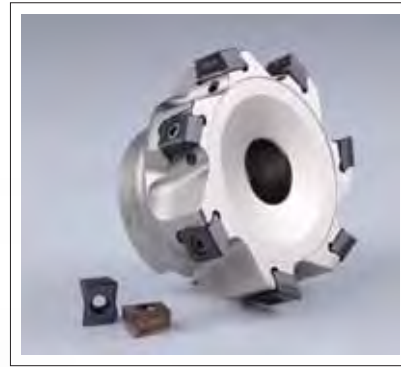

ASM90-LN13 square shoulder milling cutter with tangential mounted inserts. The insert has 4 cutting edges, can be used to machine the boss surface on the turbocharger.



AFM40-ON05-C-45, with 45 degree approach angle, using 16 cutting edge insert with wiper edge. Used in finish milling the flange face of turbocharger casing



AFM45-XN07 face milling cutter with heptagon inserts, 14 cutting edges, with nanostructured PVD coating. Used in rough milling the flange face, with a high performance/cost ratio.





AP100S/AP301M PVD grades, used in rough external turning and face turning of turbocharger housing



ATD grooving insert series can be used in external, face and V-shaped grooving.



Special boring tool, used in the turbocharger housing boring.



Insert: VCGT 110301F-UF AP301M
Holder: SVJCR 1212JX-11F
Applied to external finish turning

D151-03-1000A1 solid carbide drills for stainless steel drilling

ACHTECK

www.achtecktool.com/en

**Machining Solution
for Cellphone Camera Lens Supporting Ring**

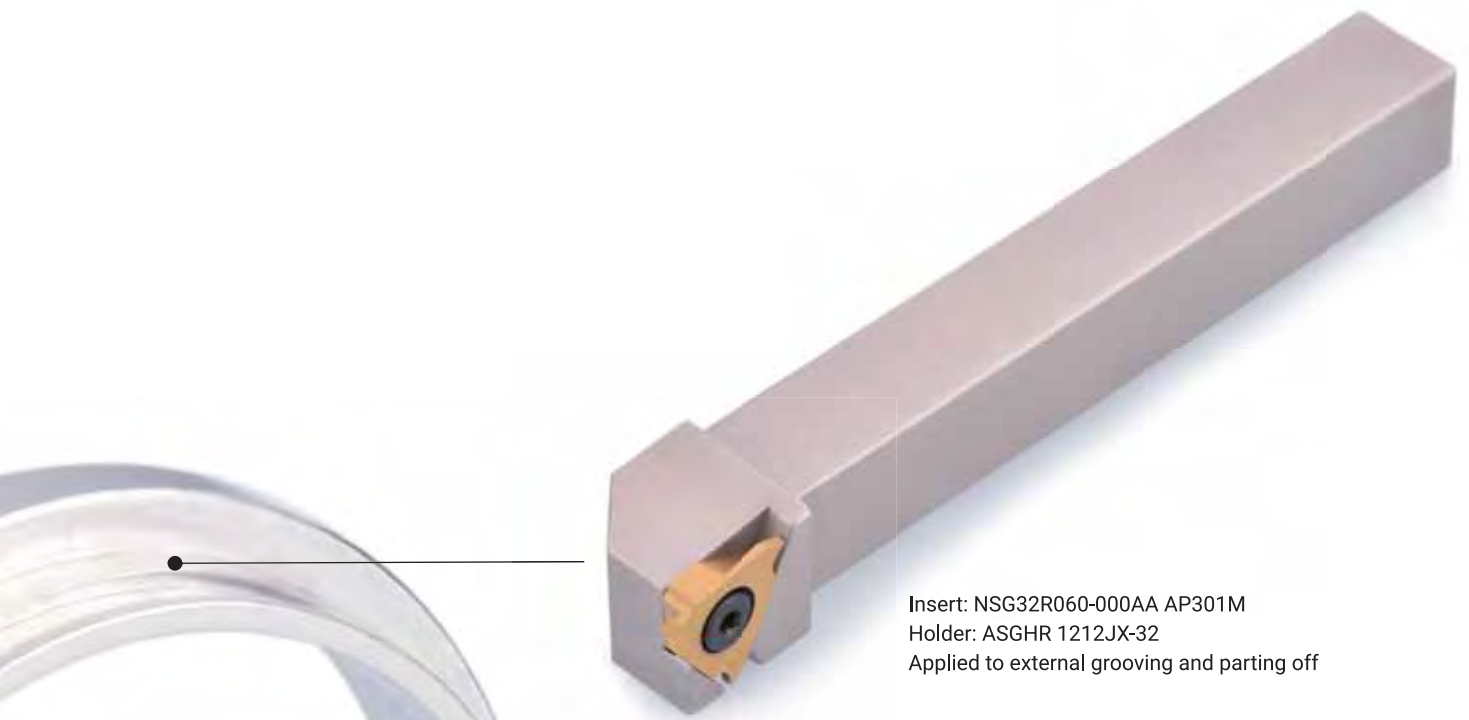

Insert: NSG32R060-000AA AP301M
Holder: ASGHR 1212JX-32
Applied to external grooving and parting off



Insert: NSW10L105-020AA AP301M
Holder: Special
Applied to internal grooving and finish boring



APM00-R012 cutter, used in rough milling of blade airfoil

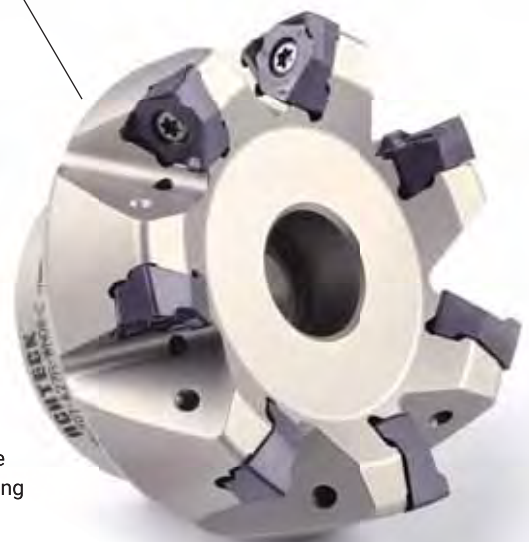

ASM90-WN08 square shoulder milling cutter with negative insert, 6 cutting edges, accurate 90 degree design, used in rough or finish milling blade root and shroud.

ACHTECK

www.achtecktool.com/en

Machining Solutions for Steam Turbine and Aircraft Turbine Blade



APM00-RP080/100 is used in rough milling the transition area between blade airfoil and root

ACHTTECK

www.achtecktool.com/en

THE EXPERT OF DIFFICULT MACHINING



CUTTING TOOL CATALOGUE

Turning Tools	22
ISO Turning Insert	24
PCBN Insert	91
PCD Insert	104
Small Tools	113
Grooving	148
Milling Tools	190
Milling	192
Solid Carbide End mills	308
Hole Machining Tools	342
Drilling	345
Boring	368
Solid Carbide Drills	397
Thread Milling Tools	422
Thread Milling	424
Tool System	432
BT Series Tool Holder	434
Holder Equipment	446
Technological Parameter	460
Index	499

ACHTTECK

www.achtecktool.com/en

THE EXPERT OF DIFFICULT MACHINING

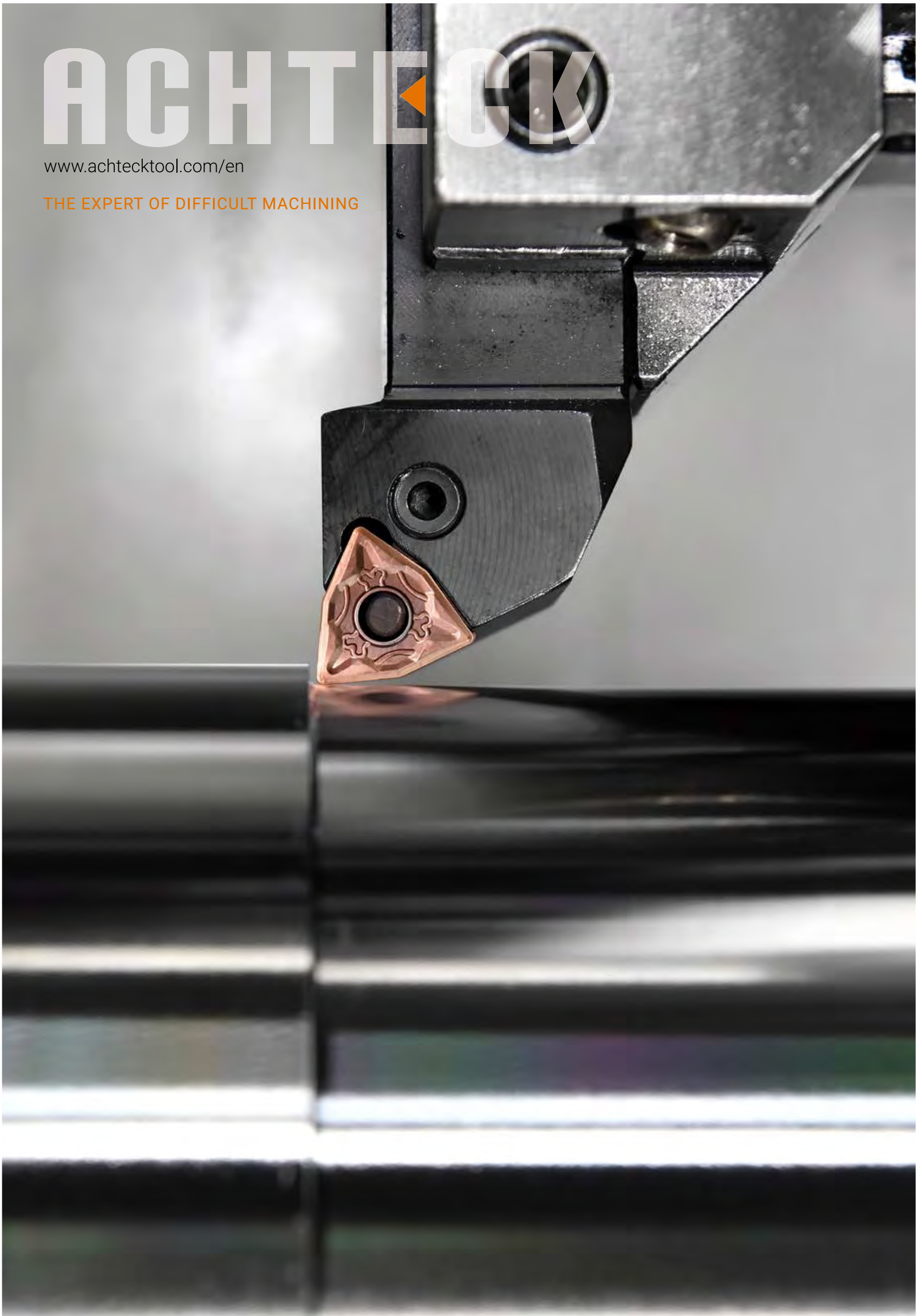

CUTTING TOOL CATALOGUE

ISO Turning Inserts	22		
ISO Turning Insert Denomination System	24	For VP..Insert	123
Overview of Turning Grades	27	External Sleeve Holder Denomination System	124
Overview of Turning Insert Geometries	28	For CC..Insert	126
Turning Grade Description	44	For DC..Insert	127
Cutting Parameter Recommended Table	46	For VB/VP..Insert	128
Negative 80° C Shape Insert	50	ABF Backturning Tool Hoder	129
Negative 55° D Shape Insert	54	ASW Multifunctional Tool Hoder	130
Negative 90° S Shape Insert	57	ASWP Parting off Series Inserts	131
Negative 60° T Shape Insert	60	ASWB Backturning Series Inserts	133
Negative 35° V Shape Insert	63	ASWT Threading Series Inserts	133
Negative 80° W Shape Insert	65	Solid Sarbide Boring Tool Hoder	134
Negative 90° L Shape Insert	68	ASIB Solid Boring Tool	135
Train Wheel Re-turning Insert	69	ASIG Solid Internal Grooving Tool	139
Positive 80° C Shape Insert	70	ASIF Solid Face Grooving Tool	144
Positive 55° D Shape Insert	74	ASIT Solid Threading Tool	145
Positive 90° S Shape Insert	78		
Positive 60° T Shape Insert	79	Grooving	148
Positive 35° V Shape Insert	84	Overview of Grooving Holders	148
Positive 80° W Shape Insert	89	ASGHR/L External shallow Grooving Holder for Swiss Lathe	151
Positive Round Insert	90	S..ASGHL External Shallow Grooving Sleeve Holder for Swiss Lathe	152
		ATGHR/L External Shallow Grooving Holder	153
		Holder Denomination System	154
PCBN Inserts	91	ATSER/L External Turning and Grooving Holder	155
PCBN Insert Denomination System	92	ATSER/L-D Reonforced External Turning and Grooving Holder	157
Overview of Grades	93	ATSER/L-SW External Turning and Grooving Holder for Swiss Lathe	158
Negative 80° C Shape Insert	94	AGUER/L External Undercutting Holder	159
Negative 55° D Shape Insert	95	ATSEFR/L Face Turning and Grooving Holder	160
Negative 90° S Shape Insert	96	ATSEFR/L-OB Face Grooving and Turning Holder (Outside Bluge Type)	161
Negative 60° T Shape Insert	97	AGSFR/L External & Face Grooving and Turning Holder	163
Negative 35° V Shape Insert	98	AGPFR/L Face Grooving and Turning Holder	164
Negative 80° W Shape Insert	99	ATPFR/L Face Grooving and Turning Holder	165
Positive 80° C Shape Insert	100	ATPIR/L Internal Turning, Grooving and Profiling Holder	166
Positive 55° D Shape Insert	101	ATGIR/L Internal Grooving Holder	167
Positive 60° T Shape Insert	102	ATSIR/L Internal & Face Grooving and Turning Holder	168
Positive 35° V Shape Insert	103	AGSIR/L Internal & Face Grooving and Turning Holder	169
		AGUIR/L Internal Undercutting holder	170
		Grooving Grade Description	171
PCD Inserts	104	Insert Geometry Introduction	173
PCD Insert Denomination System	104	Grade Application Guide	174
Overview of Grades	105	Triangular Shallow Grooving Insert Denomination System	175
Negative 80° C Shape Insert	106	Swiss Grooving-ASG Series	176
Negative 55° D Shape Insert	106	Profiling Grooving-ATG Series	177
Negative 60° T Shape Insert	107	Insert Denomination System (Pressing Insert)	179
Negative 35° V Shape Insert	107	Parting off-Grooving CS Geometry Series	179
Positive 80° C Shape Insert	108	Parting off-Grooving CM Geometry Series	180
Positive 55° D Shape Insert	109	Parting off-Grooving CH Geometry Series	181
Positive 90° S Shape Insert	109	Grooving-Turning GS Geometry Series	182
Positive 60° T Shape Insert	110	Grooving-Turning TS Geometry Series	183
Positive 35° V Shape Insert	111	Grooving-Turning TM Geometry Series	183
		Grooving-Profiling RM Geometry Series	184
Miniature Machining	113	Grooving-Profiling RA Geometry Series	184
Turning Shank Denomination System	114	Insert Denomination System (Ground Insert)	185
For CC..Insert	116	Grooving-Turning Ground Geometry Series	186
For DC..Insert	117	Blank Insert of ATBD	188
For TC..Insert	119	Cutting Parameter Recommended Table	189
For VB..Insert	120		
For VC..Insert	122		

ISO Turning Insert Denomination System

C
1

N
2

M
3

G
4

1-Shape/Code

A	B	C	D	E
H	K	L	M	O
P	R	S	T	V
W	Z	Others		

2-Clearance Angle

A	B	C	D
E	F	G	N
P	O	Others clearance angle	

3-Tolerance

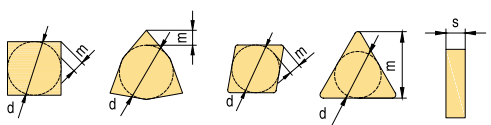

Class	Unit	In. Circle dimension d	Nose height m	Thickness s
A	mm	± 0,025	± 0,005	± 0,025
C	mm	± 0,025	± 0,013	± 0,025
E	mm	± 0,025	± 0,025	± 0,025
F	mm	± 0,013	± 0,005	± 0,025
G	mm	± 0,025	± 0,025	± 0,130
H	mm	± 0,013	± 0,013	± 0,025
J	mm	*	± 0,005	± 0,025
K	mm	*	± 0,013	± 0,025
L	mm	*	± 0,025	± 0,025
M	mm	*	*	± 0,127
U	mm	*	*	± 0,127
N	mm	*	*	± 0,025

* For details refer to right and below tables

IC	Shape: C, E, H, M, O, P, S, T, R, W			
	d		m	
	J,K,L,M,N	U	M, N	U
4.76	± 0,05	± 0,08	± 0,08	± 0,13
5.56	± 0,05	± 0,08	± 0,08	± 0,13
6	± 0,05	± 0,08	± 0,08	± 0,13
6.35	± 0,05	± 0,08	± 0,08	± 0,13
7.94	± 0,05	± 0,08	± 0,08	± 0,13
8	± 0,05	± 0,08	± 0,08	± 0,13
9.525	± 0,05	± 0,08	± 0,08	± 0,13
10	± 0,05	± 0,08	± 0,08	± 0,13
12	± 0,08	± 0,13	± 0,13	± 0,2
12.7	± 0,08	± 0,13	± 0,13	± 0,2
15.875	± 0,1	± 0,18	± 0,15	± 0,27
16	± 0,1	± 0,18	± 0,15	± 0,27
19.05	± 0,1	± 0,18	± 0,15	± 0,27
20	± 0,1	± 0,18	± 0,15	± 0,27
25	± 0,13	± 0,25	± 0,18	± 0,38
25.4	± 0,13	± 0,25	± 0,18	± 0,38
31.75	± 0,15	± 0,25	± 0,2	± 0,38
32	± 0,15	± 0,25	± 0,2	± 0,38

M&N class	D shape		V shape	
	d	m	d	m
5.56	± 0,05	± 0,11		
6.35	± 0,05	± 0,11	± 0,05	± 0,16
7.94	± 0,05	± 0,11	± 0,05	± 0,16
9.525	± 0,05	± 0,11	± 0,05	± 0,16
12.7	± 0,08	± 0,15	± 0,08	± 0,2
15.875	± 0,10	± 0,18	± 0,10	± 0,27
19.05	± 0,10	± 0,18	± 0,10	± 0,27

4-Type of Insert

A	B	C	F	G
H	J	M	N	Q
R	T	U	W	Z
				Special

12
5

04
6

5-Cutting Edge Length								
In.Circle Dimension (mm)	Insert shape							
	C	D	R	S	T	V	W	K
3.97					06		02	
5.0			05					
5.56					09			
6.0		06						
6.35	06	07			11	11	04	
8.0			08					
9.525	09	11	09	09	16	16	06	16
10.0			10					
12.0			12					
12.7	12	15	12	12	22	22	08	
15.875	16		15	15	27			
16.0			16					
19.05	19		19	19	33			
20.0			20					
25.0			25					
25.4	25		25	25				
31.75			31					
32			32					

6-Thickness		
Round down plus zero or T		
A, B, C, N, O, W		Example: 01 = 1.59 T1 = 1.98 02 = 2.38
H, M, R, T		03 = 3.18 T3 = 3.97 04 = 4.76 05 = 5.56 06 = 6.35 07 = 7.94
F, G, J, U		09 = 9.525 11 = 11.11 12 = 12.70 14 = 14.29 15 = 15.88

08
7

E
8

-
-

KC4
9

7-Nose Radius			
Corner radius			
Example			
MO = Round insert (metric)			
00 = Sharp	20 = 2.0		
003 = 0.03	24 = 2.4		
005 = 0.05	28 = 2.8		
01 = 0.1	32 = 3.2		
02 = 0.2	40 = 4.0		
04 = 0.4	48 = 4.8		
08 = 0.8	56 = 5.6		
12 = 1.2	64 = 6.4		
16 = 1.6	X = Others		
Wiper			
Approaching angle (kr)			Wiper clearance angle (an)
A = 45			A = 3°
D = 60			B = 5°
E = 75			C = 7°
F = 85			D = 15°
G = 87			E = 20°
P = 90		F = 25°	
Z = Others		G = 30°	
		N = 0°	
		P = 11°	
		Z = Others	

8-Edge Preparation		
Code	Edge shape	Description
F		Sharp cutting edge
E		Honed cutting edge
T		T-land
S		T-land+Honed cutting edge

9-Chip Breaker Description

Refer to page: P28-43

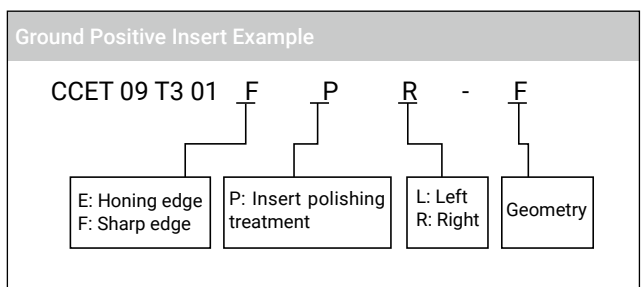

ISO Turning Insert

ACHTTECK

www.achtecktool.com/en

THE EXPERT OF DIFFICULT MACHINING



Turning Inserts





Turning and Grooving Grade Application Guide





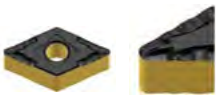
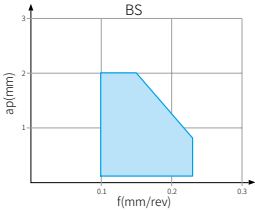
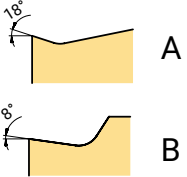
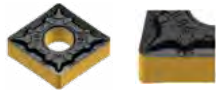
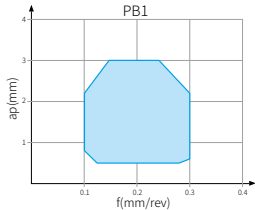
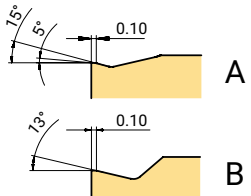
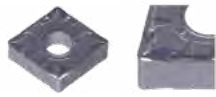
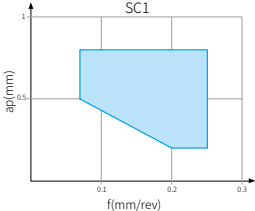
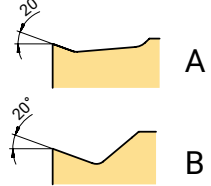

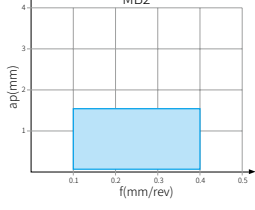
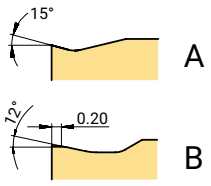

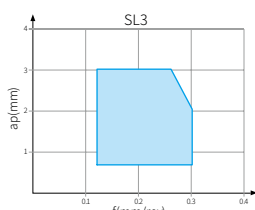
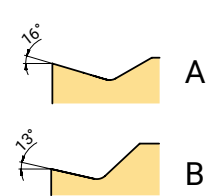







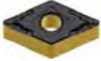







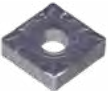





Material Group	ISO	Turning						Grooving/ Parting off			ISO
		Coated		Cermet	Uncoated	PCBN	PCD	Coated		Uncoated	
		CVD	PVD					CVD	PVD		
P Non-alloy steels/ Alloyed steels	P01	AC052P									P01
	P10	AC150P						AC230P	AP301U		P10
	P20	AC250P		AP200U					AP330M		P20
	P30	AC350P			AT202						P30
	P40										P40
	P50										P50
M Stainless steels	M01										M01
	M10	AC100M		AP100S					AP301U		M10
	M20	AC200M		AP301M					AP330M		M20
	M30			AP200U							M30
	M40										M40
K Cast iron	K01	AC100K	AC102K				PB90				K01
	K10	AC202K			AT202			AC230P	AP301U		K10
	K20										K20
	K30										K30
	K40										K40
N Aluminum/Aluminum alloys	N01										N01
	N10				AW100K			PD20		AW100K	N10
	N20										N20
	N30										N30
S Heat resistant alloys	S01			AP100S							S01
	S10	AC100M		AP301M							S10
	S20	AC200M		AP200U							S20
	S30										S30
	S40										S40
H Hardened steels/ Chilled cast iron	H01						PB30				H01
	H10										H10
	H20						PB60				H20
	H30										H30







ISO Turning Insert





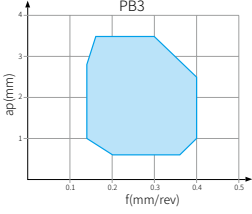
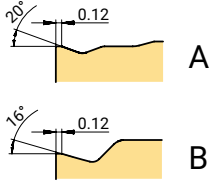

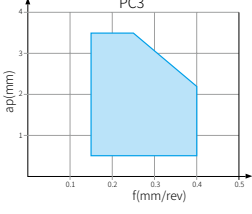
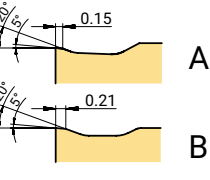
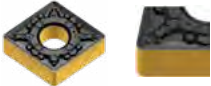
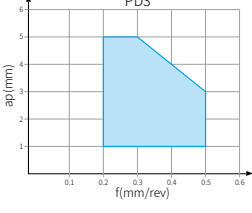
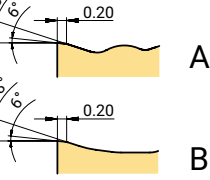
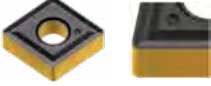
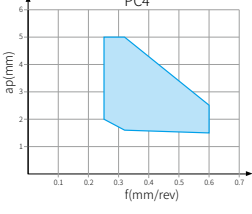
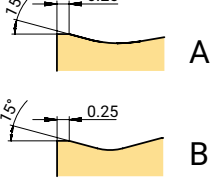

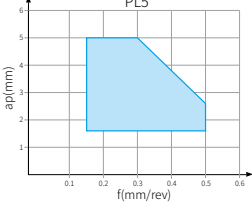
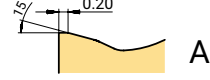







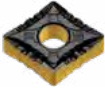
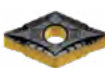



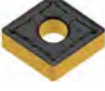
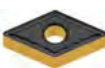

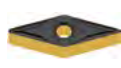

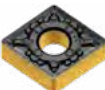
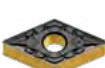

Overview of Turning Insert Geometries

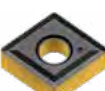
Negative Inserts





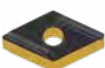



Application	Chip breaker	Features	Chip breaking range	Cross section geometry 
Profiling	<p>BS</p> 	<p>Finishing and semi-finishing profile turning Suitable for turning with changing depth of cut. Smooth chip evacuation</p>		
Finishing	<p>PB1</p> 	<p>1st choice for stainless steel finish turning Light cutting chip breaker, low cutting force, suitable for machining slender shaft, thin wall and unstably clamped parts, good cutting performance</p>		
	<p>SC1</p> 	<p>1st choice for heat resistant alloy finish turning Excellent performance at low depth of cut.</p>		
	<p>MB2</p> 	<p>1st choice for stainless steel finish turning High positive rake angle reduced cutting force and built-up edge, can obtain much better surface quality. Very good chip breaking at low feed and cutting depth.</p>		
Light cutting	<p>SL3</p> 	<p>Recommended for heat resistant alloy light turning. Suitable for heat resistant alloy, Ti-alloy. Sharp and wavy cutting edge can get good surface finish and good chip breaking results.</p>		



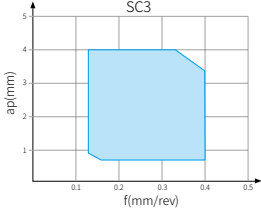
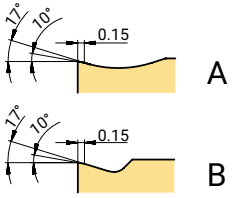

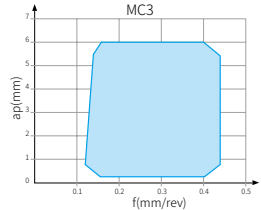
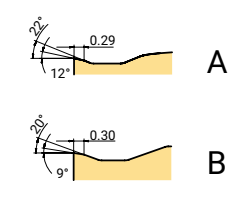
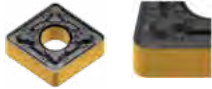
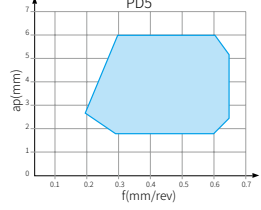
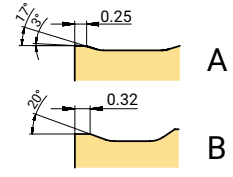

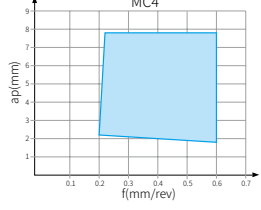
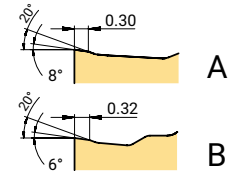
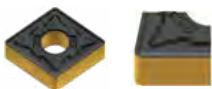
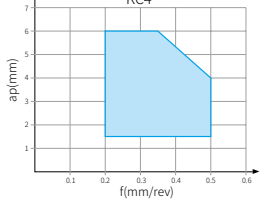
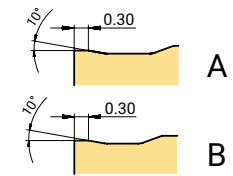

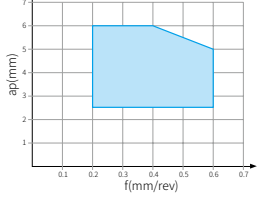
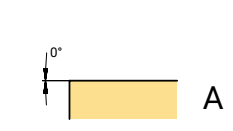



















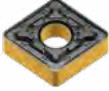







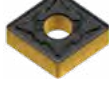

	80° Rhombus 	55° Rhombus 	90° Square 	60° Triangle 	35° Rhombus 	80° Trigon 	Round 
		DNMG-BS  P54			VNMG-BS  P63		
	CNMG-PB1  P50	DNMG-PB1  P54	SNMG-PB1  P57	TNMG-PB1  P60	VNMG-PB1  P63	WNMG-PB1  P65	
	CNMG-SC1  P50	DNMG-SC1  P54		TNMG-SC1  P60	VNMG-SC1  P63	WNMG-SC1  P65	
	CNMG-MB2  P50	DNMG-MB2  P54	SNMG-MB2  P57	TNMG-MB2  P60	VNMG-MB2  P63	WNMG-MB2  P65	
	CNMG-SL3  P50	DNMG-SL3  P54	SNMG-SL3  P57	TNMG-SL3  P60	VNMG-SL3  P63	WNMG-SL3  P65	

Application	Chip breaker	Features	Chip breaking range	Cross section geometry 
Semi-finishing	<p>PB3</p> 	<p>1st choice for steel semi finish turning</p> <p>The positive rake angle combined with small land guaranteed edge strength and sharpness, reduced the cutting force. The wavy side edge design has a good chip breaking result in out-copying turning on the shoulder, and in profile turning at different cutting depths.</p>		
	<p>PC3</p> 	<p>Alternative chipbreaker for steel semi-finish turning</p> <p>Unique geometry design offers wider chip breaking range. Double rake angle makes the cutting smoothly. Enhanced insert tip reduced crater wear.</p>		
Medium	<p>PD3</p> 	<p>1st choice for steel medium turning</p> <p>It has a strong chip control ability at low feed and cutting depth, and reduces crater wear. The chip breaking is also very good at high feed and cutting depth due to the geometry design. Double rake angle design makes sharp cutting edge and reduces cutting force.</p>		
	<p>PC4</p> 	<p>1st choice for cast iron medium turning</p> <p>Alternative chipbreaker for carbon steel and alloy steel medium turning</p> <p>Flat T-land guarantee the strength of cutting edge. This multi-purpose geometry can be used in universal applications.</p>		
	<p>PL5</p> 	<p>1st choice for steel slender bar turning</p> <p>Open chip breaker leads to smooth cutting with low cutting force, which is suitable for slender shaft turning.</p>		



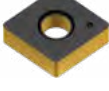



	80° Rhombus 	55° Rhombus 	90° Square 	60° Triangle 	35° Rhombus 	80° Trigon 	Round 
	<p>CNMG-PB3</p>  <p>P50</p>	<p>DNMG-PB3</p>  <p>P54</p>		<p>TNMG-PB3</p>  <p>P60</p>	<p>VNMG PB3</p>  <p>P63</p>	<p>WNMG-PB3</p>  <p>P65</p>	
	<p>CNMG-PC3</p>  <p>P50</p>	<p>DNMG-PC3</p>  <p>P55</p>	<p>SNMG-PC3</p>  <p>P57</p>	<p>TNMG-PC3</p>  <p>P60</p>	<p>VNMG-PC3</p>  <p>P63</p>	<p>WNMG-PC3</p>  <p>P65</p>	
	<p>CNMG-PD3</p>  <p>P50</p>	<p>DNMG-PD3</p>  <p>P55</p>	<p>SNMG-PD3</p>  <p>P57</p>	<p>TNMG-PD3</p>  <p>P60</p>	<p>VNMG-PD3</p>  <p>P64</p>	<p>WNMG-PD3</p>  <p>P66</p>	
	<p>CNMG-PC4</p>  <p>P51</p>	<p>DNMG-PC4</p>  <p>P56</p>	<p>SNMG-PC4</p>  <p>P58</p>	<p>TNMG-PC4</p>  <p>P61</p>	<p>VNMG-PC4</p>  <p>P64</p>	<p>WNMG-PC4</p>  <p>P66</p>	
		<p>DNMG-PL5</p>  <p>P55</p>		<p>TNMG-PL5</p>  <p>P60</p>		<p>WNMG-PL5</p>  <p>P66</p>	



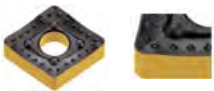
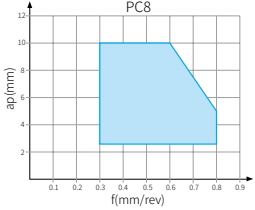
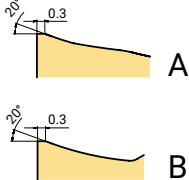

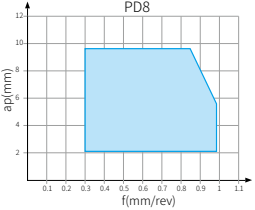
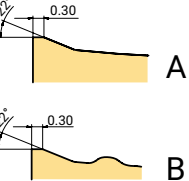

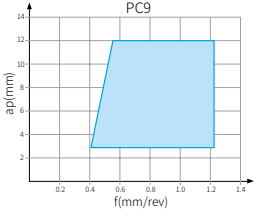
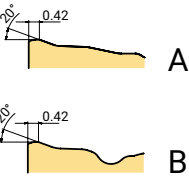

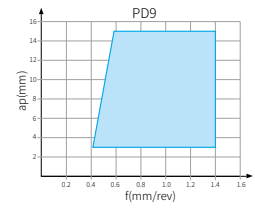
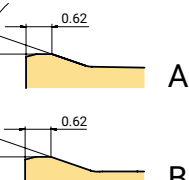





ISO Turning Insert

Application	Chip breaker	Features	Chip breaking range	Cross section geometry 
Medium	<p>SC3</p> 	<p>1st choice for heat resistant alloy medium turning</p> <p>Used in heat resistant alloy and titanium alloy medium turning. Large rake angle + small land width design, easy cutting, is also suitable for soft steel turning.</p>		
	<p>MC3</p> 	<p>1st choice for stainless steel medium turning</p> <p>Sharp cutting edge, low cutting force, wide chip breaking range and good chip removal ability.</p>		
Roughing	<p>PD5</p> 	<p>Alternative chipbreaker for steel rough turning</p> <p>A strong cutting edge. Double rake angle design effectively reduces the cutting force, can still have good chip breaking at small cutting depth.</p>		
	<p>MC4</p> 	<p>Alternative chipbreaker for stainless steel and heat resistant alloy rough turning</p> <p>Large chip breaker design, smooth chip evacuation, good chip breaking, with high metal removal rate.</p>		
	<p>KC4</p> 	<p>1st choice for cast iron turning</p> <p>It has strong cutting edge, reliable and stable performance.</p>		
	<p>KD5</p> 	<p>1st choice for cast iron rough turning</p> <p>High cutting edge strength, suitable for interrupt cutting and unstable cutting.</p>		

	80° Rhombus 	55° Rhombus 	90° Square 	60° Triangle 	35° Rhombus 	80° Trigon 	Round 
	<p>CNMG-SC3</p>  <p>P51</p>	<p>DNMG-SC3</p>  <p>P55</p>	<p>SNMG-SC3</p>  <p>P57</p>	<p>TNMG-SC3</p>  <p>P60</p>	<p>VNMG-SC3</p>  <p>P64</p>	<p>WNMG-SC3</p>  <p>P66</p>	
	<p>CNMG-MC3</p>  <p>P51</p>	<p>DNMG-MC3</p>  <p>P55</p>	<p>SNMG-MC3</p>  <p>P57</p>	<p>TNMG-MC3</p>  <p>P61</p>	<p>VNMG-MC3</p>  <p>P64</p>	<p>WNMG-MC3</p>  <p>P66</p>	
	<p>CNMG-PD5</p>  <p>P52</p>	<p>DNMG-PD5</p>  <p>P56</p>	<p>SNMG-PD5</p>  <p>P58</p>	<p>TNMG-PD5</p>  <p>P61</p>		<p>WNMG-PD5</p>  <p>P67</p>	
	<p>CNMG-MC4</p>  <p>P51</p>	<p>DNMG-MC4</p>  <p>P56</p>	<p>SNMG-MC4</p>  <p>P58</p>	<p>TNMG-MC4</p>  <p>P61</p>		<p>WNMG-MC4</p>  <p>P67</p>	
	<p>CNMG-KC4</p>  <p>P52</p>	<p>DNMG-KC4</p>  <p>P56</p>	<p>SNMG-KC4</p>  <p>P58</p>	<p>TNMG-KC4</p>  <p>P61</p>	<p>VNMG-KC4</p>  <p>P64</p>	<p>WNMG-KC4</p>  <p>P67</p>	
	<p>CNMA-KD5</p>  <p>P52</p>	<p>DNMA-KD5</p>  <p>P56</p>	<p>SNMA-KD5</p>  <p>P59</p>	<p>TNMA-KD5</p>  <p>P62</p>		<p>WNMA-KD5</p>  <p>P67</p>	

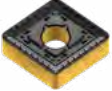

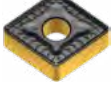



ISO Turning Insert





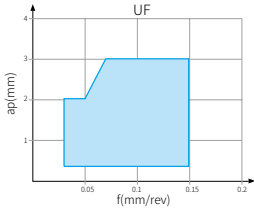
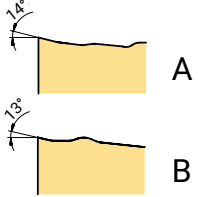

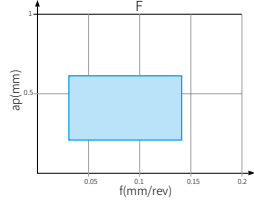

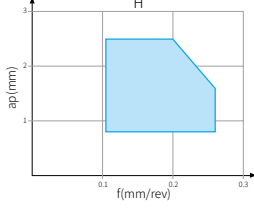
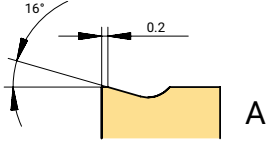

Application	Chip breaker	Features	Chip breaking range	Cross section geometry 	
Heavy roughing	<p>PC8</p> 	<p>Light cutting geometry for heavy turning Positive rake angle and curved cutting edge design, low cutting force.</p>			
	<p>PD8</p> 	<p>Heavy turning geometry for soft steel and stainless steel The geometry design ensures low cutting force. Suitable for low power machine tools. Applied in steel, stainless steel and cast iron heavy turning.</p>			
	<p>PC9</p> 	<p>1st choice for steel heavy rough turning Wavy geometry is good for chip breaking. The geometry has a big space for chips, which is suitable for high metal removal rate.</p>			
	<p>PD9</p> 	<p>Alternative chipbreaker for steel heavy rough turning High edge strength is suitable for big cutting depth and high feed turning. High machining reliability.</p>			

	80° Rhombus 	55° Rhombus 	90° Square 	60° Triangle 	35° Rhombus 	80° Trigon 	Round 
	CNMM-PC8  P53						
	CNMM-PD8  P53		SNMM-PD8  P59	TNMM-PD8  P62			
	CNMM-PC9  P53		SNMM-PC9  P59				
	CNMM-PD9  P53		SNMM-PD9  P59				

ISO Turning Insert

Negative Ground Insert







Application	Chip breaker	Features	Chip breaking range	Cross section geometry 
Finishing	<p>UF</p> 	<p>Suitable for precision turning Low cutting forces, good chip breaking, suitable for finish turning.</p>		
	<p>F</p> 	<p>Finish turning Low cutting force, good chip control. The sharp edge produces a good surface finish.</p>		
Semi-finishing-Rough machining	<p>H</p> 	<p>Light turning Excellent chip control at low to medium feed rates. Strong edge strength.</p>		





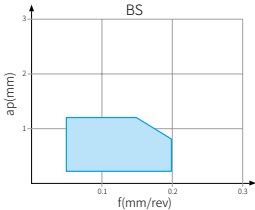
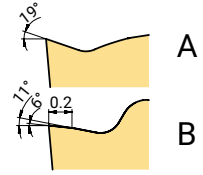

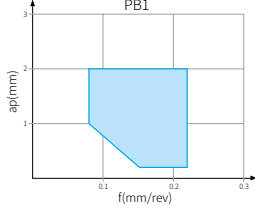
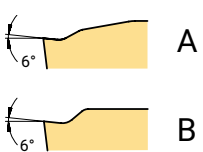

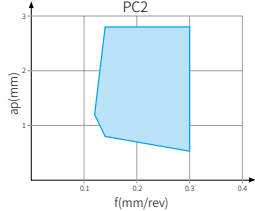
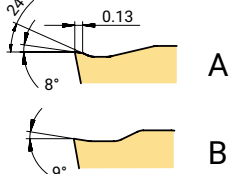





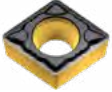
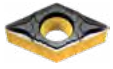

80° Rhombus 	55° Rhombus 	90° Square 	60° Triangle 	35° Rhombus 	80° Trigon 	Round 
			TNGG-UF  P62	VNGG-UF  P64		
			TNGG-F  P62			
			TNGG-H  P62			

ISO Turning Insert



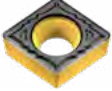
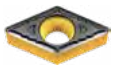



Overview of Turning Insert Geometry



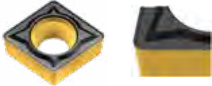
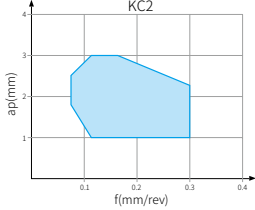
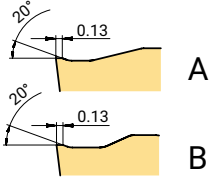
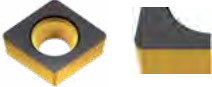
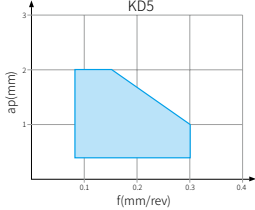
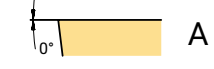

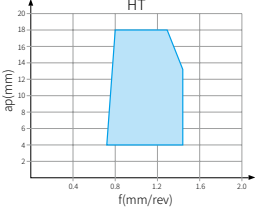
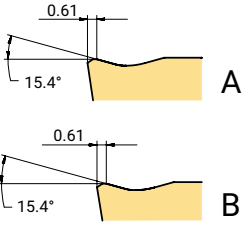

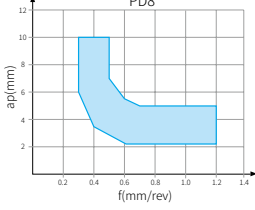
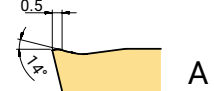

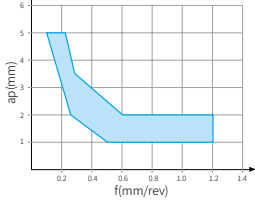
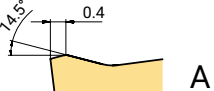





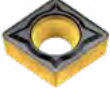
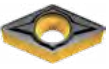

Positive Pressed Insert

Application	Chip breaker	Features	Chip breaking range	Cross section geometry 
Profiling	<p>BS</p> 	<p>Finish turning Profile turning or turning with changing depth of cut, smooth chip evacuation.</p>		
Finishing	<p>PB1</p> 	<p>1st choice for steel finish turning Positive rake angle reduces cutting force and built-up edge, and obtains better surface finish and longer tool life. Also can be used in stainless steel turning.</p>		
Semi-finishing	<p>PC2</p> 	<p>1st choice for steel and stainless steel semi-finish turning Sharp geometry design ensures low cutting force, less built-up edge and excellent chip control.</p>		

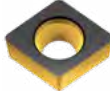
	80° Rhombus 	55° Rhombus 	90° Square 	60° Triangle 	35° Rhombus 	80° Trigon 	Round 
					VBMT-BS  P85		
	CCMT-PB1 CPMT-PB1  P71	DCMT-PB1  P75	SCMT-PB1  P78	TCMT-PB1 TPMT-PB1  P80	VBMT-PB1 VCMT-PB1  P86		
	CCMT-PC2 CPMT-PC2  P71	DCMT-PC2  P75	SCMT-PC2  P78	TCMT-PC2 TPMT-PC2  P80	VBMT-PC2 VCMT-PC2  P86		











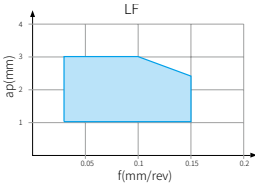
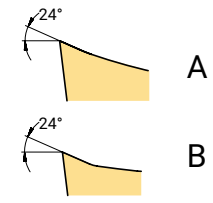

ISO Turning Insert

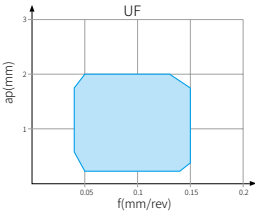
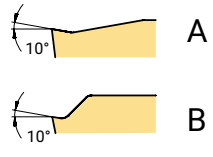

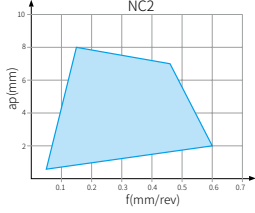
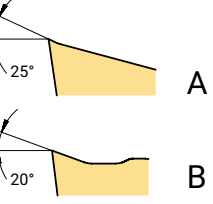

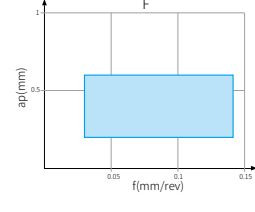

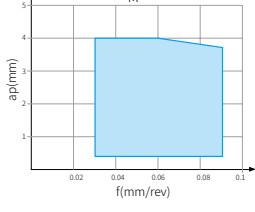
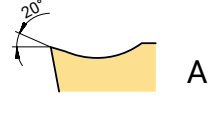

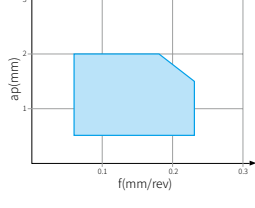
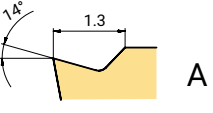





















Application	Chip breaker	Features	Chip breaking range	Cross section geometry 
Medium	KC2 	General purpose geometry for steel, stainless steel and cast iron turning Suitable for medium and rough turning. Simple and durable chip breaker design, very good versatility and wide application range.		
Roughing	KD5 	Geometry for cast iron rough turning Suitable for unstable machining due to its strong cutting edge. Reduced chipping.		
	HT 	Geometry for steel turning with large cutting depth Open chip breaker is suitable for large cutting depth with smooth chip evacuation. Good cost efficiency.		
Semi-finishing	PD8 	Geometry for carbon steel and alloy steel heavy turning A wide chipbreaker avoid chip jam at big cutting depth. Chip control can be also good at small cutting depth.		
Medium	No code 	Alternative chipbreaker for cast iron and alloy steel medium turning Negative land and big rake angle design ensure cutting edge strength and sharpness.		

80° Rhombus 	55° Rhombus 	90° Square 	60° Triangle 	35° Rhombus 	80° Trigon 	Round 
<p>CCMT-KC2</p>  <p>P72</p>	<p>DCMT-KC2</p>  <p>P75</p>	<p>SCMT-KC2</p>  <p>P78</p>	<p>TCMT-KC2</p>  <p>P81</p>	<p>VBMT-KC2</p>  <p>P86</p>		
<p>CCMW-KD5</p>  <p>P72</p>	<p>DCMW-KD5</p>  <p>P76</p>	<p>SCMW-KD5</p>  <p>P78</p>	<p>TCMW-KD5</p>  <p>P81</p>			
		<p>SCMT-HT</p>  <p>P78</p>				
						<p>RCMX-PD8</p>  <p>P90</p>
						<p>RCMX</p>  <p>P90</p>

ISO Turning Insert

Positive Ground Insert

Application	Chip breaker	Features	Chip breaking range	Cross section geometry 
Finishing	<p>LF</p> 	<p>Finish turning Sharp cutting edge, low cutting force, suitable for Swiss-type automatic lathe with 2 direction machining.</p>		
	<p>UF</p> 	<p>1st choice for heat resistant alloy turning Peripheral ground finish turning inserts. High repeatability on insert positioning. Sharp cutting edge can achieve good machining tolerance.</p>		
Semi-finishing	<p>NC2</p> 	<p>Choice for aluminium alloy turning Very positive rake angle is designed for non-ferrous metal finish and semi-finish turning. It reduces the cutting force and make smooth chip evacuation. The polished rake surface, with reduced friction and built-up edge.</p>		
Finishing	<p>F</p> 	<p>Choice for finish turning Excellent chip control at low feed rate. Very low cutting force.</p>		
Low feed	<p>M</p> 	<p>Suitable for medium turning in automatic lathes Excellent chip control at low to medium feed rate. Reliable machining. Big rake angle avoid work hardening.</p>		
Semi-finishing	<p>Y</p> 	<p>Choice for semi-finish rough turning in automatic lathe The strong edge can be used in rough turning. Good chip control for low to medium feed rate</p>		

	80° Rhombus 	55° Rhombus 	90° Square 	60° Triangle 	35° Rhombus 	80° Trigon 	Round 
	<p>CCGT-LF</p>  <p>P70</p>	<p>DCGT-LF</p>  <p>P74</p>		<p>TCGT-LF</p>  <p>P79</p>	<p>VBGT-LF VCGT-LF VPGT-LF</p>  <p>P84</p>		
	<p>CCGT-UF</p>  <p>P70</p>	<p>DCGT-UF</p>  <p>P74</p>		<p>TCGT-UF</p>  <p>P79</p>	<p>VBGT-UF VCGT-UF VPGT-UF</p>  <p>P84, 85</p>		
	<p>CCGT-NC2</p>  <p>P71</p>	<p>DCGT-NC2</p>  <p>P75</p>	<p>SCGT-NC2</p>  <p>P78</p>	<p>TCGT-NC2</p>  <p>P79</p>	<p>VCGT-NC2</p>  <p>P85</p>	<p>RCGT-NC2</p>  <p>P90</p>	
	<p>CCET-F</p>  <p>P73</p>	<p>DCET-F</p>  <p>P76</p>		<p>TBET-F TCET-F TPEH-F</p>  <p>P81, 82, 83</p>	<p>VBET-F VCET-F VPET-F</p>  <p>P86, 87</p>	<p>WBET-F</p>  <p>P89</p>	
	<p>CCET-M</p>  <p>P73</p>	<p>DCET-M</p>  <p>P77</p>		<p>TCET-M</p>  <p>P83</p>	<p>VBET-M VPET-M</p>  <p>P87, 88</p>		
					<p>VBET-Y</p>  <p>P88</p>		

ISO Turning Insert

Turning Grade Description

Basic Grades for Turning

P Steel, cast steel, ferrite/martensite stainless steel and malleable cast iron

Basic grade

AC052P P05(P01-P15)

CVD coated grade, has good crater resistance and chipping resistance, which is recommended for high productivity medium and rough turning in stable condition, can keep edge reliability in dry or wet machining with high temperature.

AC150P P15(P10-P25)

CVD coated grade, can be used in finish to rough turning on steel and cast steel, and is recommended in continuous and light interrupted cutting where it can keep high metal removal rate.

AC250P P25(P20-P35)

CVD coated grade, 1st choice for steel turning, used in finish to rough turning on steel and cast steel. It's recommended for continuous and interrupted machining.

AC350P P35(P25-P45)

CVD coated grade, can be used in rough turning on steel and cast steel under poor conditions. Reliable cutting edge made this grade good for interrupted machining with high metal removal rate.

Supplemental grade

AP200U P25(P15-P35)

PVD coated grade, recommended for finish turning on low carbon steel with low cutting speed or low feed.

AC200M P35(P25-P40)

CVD coated grade. Supplemental grade for steel turning with high toughness requests.

AT202 P15(P10-P20)

Uncoated cermet grade. It has excellent built-up edge resistance and chipping resistance which can be used in finish turning with good surface quality or low cutting force requests.

M Austenitic stainless steel, cast steel, manganese steel, alloyed cast iron, malleable cast iron and free cutting iron.

Basic grade

AC100M M15(M05-M20)

CVD coated grade. It's recommended for finish machining and light rough machining. It's suitable for machining at medium to high cutting speed due to its heat resistance feature of wear resistant coating.

AC200M M25(M15-M30)

CVD coated grade, optimised for semi-finish to rough turning, can be used in interrupted machining in which it can keep edge reliability due to good thermal shock stability and mechanical shock resistance.

AP200U M25(M15-M35)

PVD coated grade, used in finish turning at low to medium speed and also in interrupted turning due to excellent thermal stability, outstanding performance in machining when sharp edge and edge toughness or good surface quality are requested.

AP301M M25(M15-M35)

PVD coated grade. Mainly used in machining steel and stainless steel small parts. It has excellent built-up edge resistance, good machining stability, can obtain good surface quality, and achieve longer tool life.

Supplemental grade

AP100S M15(M05-M25)

PVD coated grade, recommended for finish turning due to its high hardness and resistance to plastic deformation.

K**Cast iron, chilled cast iron and short chip malleable cast iron****Basic grade****AC100K K05(K01-K15)**

CVD coated grade, has thick and smooth wear resistant coating and hard substrate, recommended for grey cast iron high speed turning.

AC102K K05(K01-K15)

CVD coated grade, has thick and smooth wear resistant coating and hard substrate, recommended for nodular cast iron high speed turning.

AC202K K15(K10-K30)

1st choice for cast iron turning. It can deal with interrupted cutting due to its high wear-resistant CVD coating, used in finish to rough turning on cast iron at low to medium cutting speed.

Supplemental grade**PB60 K15(K10-K30)**

CBN grade. 1st choice for grey cast iron continuous and interrupted finish turning at high speed due to its good edge strength and wear resistance.

PB90 K10(K01-K20)

CBN grade. Suitable for grey cast iron and chilled cast iron interrupted finish turning due to its good edge strength and wear resistance.

AT202 K15(K10-K20)

Uncoated cermet grade. It has excellent built-up edge resistance and good plastic deformation resistance. It can be used in nodular cast iron finish turning when surface quality, small tolerance or low cutting force are requested..

N**Non-ferrous metals****Basic grade****AW100K N15 (N05-N15)**

Uncoated grade. It has both excellent wear resistance and sharp edge. Used in Al alloy rough to finish machining.

PD20 N10 (N01-N20)

PCD grade, used in non-ferrous material and non-metal material machining which can have longer tool life, completely clean cutting and good surface quality.

S**Heat resistant alloys****Basic grade****AP100S S15(S05-S25)**

1st choice for heat resistant alloy. PVD coated grade has high hardness and plastic deformation resistance, can keep high performance and good wear resistance.

AP200U S25(S15-S35)

PVD coated grade. Used in low cutting speed or light interrupted cutting. Suitable for semi-roughing or continuous machining for a short time due to its good notch wear resistance and anti-heat shock capability.

Supplemental grade**AC100M S15(S05-S20)**

CVD coated grade, suitable for heat resistant alloy continuous high speed machining .

AC200M S25(S15-S35)

CVD coated grade, suitable for heat resistant alloy general machining.

H**Hardened materials****Basic grade****PB30 H10(H05-H15)**

CBN grade with low CBN content, is used in hardened steel continuous machining at high speed and light interrupted machining.

PB60 H15(H10-H25)

1st choice of CBN grade medium CBN content for hardened steel interrupted machining and continuous machining at medium speed.

PB90 H25 (H20-H30)

Extra-hard CBN grade. Supplemental choice for hardened steel interrupted machining due to its good edge toughness.

Cutting Data Recommendation--Negative Insert

ISO		Materials		Workpiece Materials													
				Brinell Hardness (HB)	Tensile strength (N/mm ²)	AT202			AC052P			AC150P			AC250P		
						f (mm/rev)			f (mm/rev)			f (mm/rev)			f (mm/rev)		
						0.1	0.4	0.6	0.1	0.4	0.6	0.1	0.4	0.6	0.1	0.4	0.6
P	Unalloyed steel	C ≤ 0.25%	Annealed	125	428	200	100	70	620	450	330	485	360	270	380	260	210
		0.25 < C ≤ 0.55%	Annealed	190	639	200	100	70	560	405	295	370	270	210	280	200	150
		0.25 < C ≤ 0.55%	Heat-treated	210	708	200	80	50	400	280	200	260	220	170	200	160	135
		C > 0.55%	Annealed	190	639	200	80	50	530	385	275	270	220	160	240	160	125
		C > 0.55%	Heat-treated	300	1013	200	80	50	380	245	180	210	180	150	160	120	110
	Free cutting steel(short chip)	Annealed	220	745	200	80	50	600	420	300	440	310	250	340	220	175	
	Low-alloyed steel	Annealed	175	591	180	80	50	610	410	285	350	260	220	240	175	135	
		Heat-treated	300	1013	180	80	50	530	350	250	220	170	150	140	100	85	
		Heat-treated	380	1282	180	80	50	330	230	175	160	120	100	100	70	55	
		Heat-treated	430	1477	180	80	50	265	185	140	90	70					
	High-alloyed steel and high-alloyed tool steel	Annealed	200	675	160	80	50	445	295	215	330	230	150	210	145	85	
		Hardened and tempered	300	1013	160	80	50	300	200	160	230	140	110	130	85	65	
Hardened and tempered		400	1361	150	80	50	220	140	105	80	70						
Stainless steel	Ferritic/Martensite,Annealed	200	675										180	150	120		
	Martensite,Heat-treated	330	1114										140	100	70		
M	Stainless steel	Austenitic,hardened	200	675													
		Austenitic,precipitation hardened stainless steel(PH stainless steel)	300	1013													
		Austenitic,ferritic,duplex	230	778													
K	Malleable cast iron	Ferritic	200	400													
		Pearlitic	260	700													
	Grey cast iron	Low tensile strength	180	200													
		High tensile strength/Austenitic	245	350													
	Nodular cast iron	Ferritic	155	400													
Pearlitic		265	700														
		GGV(CGI)	230	400													
N	Wrought aluminum alloy	Non-aging alloy	30	-													
		Aged alloy	100	340													
	Cast aluminum alloy	≤ 12% Si, non-aging alloy	75	260													
		≤ 12% Si, aged alloy	90	310													
		> 12% Si, non-aging alloy	130	450													
	Magnesium alloy		70	250													
	Copper and copper alloy(bronze/ brass)	Unalloyed,electrolytic copper	100	340													
Brass,bronze,red brass		90	310														
Cu alloy,short chip		110	380														
High tensile,Ampco alloy		300	1010														
S	Heat-resistant alloy	Fe-based	Annealed	200	680												
			Aged	280	940												
		Ni or Co based	Annealed	250	840												
			Aged	350	1180												
		Cast	320	1080													
	Titanium alloy	Pure Titanium	200	680													
		α and β alloy,aged	375	1260													
		β alloy	410	1400													
Tungsten alloy		300	1010														
Molybdenum alloy		300	1010														
H	Hardened steel	Hardened and tempered	50HRC														
		Hardened and tempered	55HRC														
		Hardened and tempered	60HRC														
	Chilled cast iron	Hardened and tempered	50HRC														

*The recommended cutting data always refer to general cutting conditions. The actual selection should be adjusted according to the factors such as machine rigidity, tool body, workpiece conditions and coolant (f should be adjust according to insert radius)

Achteck turning grade

Initial value of cutting speed Vc(m/min)

AC350P			AC100M			AC200M			AP200U			AC100K			AC102K			AC202K			AW100K			AP100S		
f (mm/rev)									f (mm/rev)									f (mm/rev)								
0.1	0.4	0.6	0.1	0.4	0.6	0.1	0.4	0.6	0.1	0.4	0.6										0.1	0.2	0.4	0.1	0.3	0.5
[Blue Section - Rows 1-10]																										
[Yellow Section - Rows 11-13]																										
[Red Section - Rows 14-16]																										
[Green Section - Rows 17-20]																										
[Orange Section - Rows 21-24]																										
[Light Blue Section - Rows 25-27]																										

Cutting Data Recommendation--Positive Insert

ISO		Materials		Brinell Hardness (HB)	Tensile strength (N/mm ²)	Cutting Data											
						AT202			AC052P			AC150P			AC250P		
						f (mm/rev)			f (mm/rev)			f (mm/rev)			f (mm/rev)		
						0.1	0.2	0.4	0.1	0.2	0.4	0.1	0.2	0.4	0.1	0.2	0.4
P	Unalloyed steel	C ≤ 0.25%	Annealed	125	428	200	100	70	600	430	310	465	400	330	360	310	260
		0.25 < C ≤ 0.55%	Annealed	190	639	200	100	70	540	385	275	360	330	260	290	250	190
		0.25 < C ≤ 0.55%	Heat-treated	210	708	200	80	50	380	260	180	270	240	220	200	180	160
		C > 0.55%	Annealed	190	639	200	80	50	520	365	255	330	300	290	250	220	210
		C > 0.55%	Heat-treated	300	1013	200	80	50	360	225	160	210	180	170	160	130	120
	Free cutting steel(short chip)	Annealed	220	745	200	80	50	580	400	280	440	400	380	320	290	275	
	Low-alloyed steel	Annealed	175	591	180	80	50	590	390	265	330	310	300	260	240	220	
		Heat-treated	300	1013	180	80	50	510	330	230	180	170	160	135	120	100	
		Heat-treated	380	1282	180	80	50	320	210	155	120	100	90	100	85	65	
		Heat-treated	430	1477	180	80	50	265	165	120	80	70		65	55		
	High-alloyed steel and high-alloyed tool steel	Annealed	200	675	160	80	50	425	275	195	320	290	280	270	240	220	
		Hardened and tempered	300	1013	160	80	50	280	180	140	200	170	150	170	140	120	
Hardened and tempered		400	1361	150	80	50	200	120	105	80	70		65	55			
Stainless steel	Ferritic/Martensite,Annealed	200	675										190	170	150		
	Martensite,Heat-treated	330	1114										90	80	60		
M	Stainless steel	Austenitic,hardened	200	675													
		Austenitic,precipitation hardened stainless steel(PH stainless steel)	300	1013													
		Austenitic,ferritic,duplex	230	778													
K	Malleable cast iron	Ferritic	200	400													
		Pearlitic	260	700													
	Grey cast iron	Low tensile strength	180	200													
		High tensile strength/Austenitic	245	350													
	Nodular cast iron	Ferritic	155	400													
Pearlitic		265	700														
		GGV(CGI)	230	400													
N	Wrought aluminum alloy	Non-aging alloy	30	-													
		Aged alloy	100	340													
	Cast aluminum alloy	≤ 12% Si, non-aging alloy	75	260													
		≤ 12% Si, aged alloy	90	310													
		> 12% Si, non-aging alloy	130	450													
	Magnesium alloy	70	250														
	Copper and copper alloy(bronze/ brass)	Unalloyed,electrolytic copper	100	340													
Brass,bronze,red brass		90	310														
Cu alloy,short chip		110	380														
High tensile,Ampco alloy		300	1010														
S	Heat-resistant alloy	Fe-based	Annealed	200	680												
			Aged	280	940												
		Ni or Co based	Annealed	250	840												
			Aged	350	1180												
		Cast	320	1080													
	Titanium alloy	Pure Titanium	200	680													
		α and β alloy,aged	375	1260													
β alloy		410	1400														
Tungsten alloy	300	1010															
Molybdenum alloy	300	1010															
H	Hardened steel	Hardened and tempered	50HRC														
		Hardened and tempered	55HRC														
		Hardened and tempered	60HRC														
	Chilled cast iron	Hardened and tempered	50HRC														

*The recommended cutting data always refer to general cutting conditions. The actual selection should be adjusted according to the factors such as machine rigidity, tool body, workpiece conditions and coolant (f should be adjust according to insert radius)

Negative 80° (C)

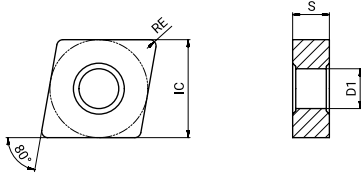

Dimension (mm)			
Product code	IC	S	D1
CN_1204_	12.7	4.76	5.16
CN_1606_	15.875	6.35	6.35
CN_1906_	19.05	6.35	7.94

Inserts	Product code	RE (mm)	Recommended parameters		Machining conditions																									
			f (mm/rev)	ap (mm)	p					M				K			N	S												
					AT202	AC052P	AC150P	AC250P	AC350P	AC100M	AC200M	AP200U	AP301M	AC100K	AC102K	AC202K	AW100K	AP100S												
Finishing	 CNMG 120404E-PB1 120408E-PB1 120412E-PB1	0.4	0.05-0.15	0.26-3.2	●		▲	▲																						
		0.8	0.10-0.30	0.52-3.2	●		▲	▲																						
		1.2	0.15-0.45	0.78-3.2			▲	▲																						
	 CNMG 120404E-SC1 120408E-SC1	0.4	0.07-0.18	0.20-0.8																										
		0.8	0.10-0.25	0.20-0.8																										
	 CNMG 120404E-MB2 120408E-MB2	0.4	0.05-0.15	0.26-3.2							●	●	●																	
0.8		0.10-0.30	0.52-3.2							●	●	●																		
Light cutting	 CNMG 120404E-SL3 120408E-SL3	0.4	0.12-0.25	0.60-3.0																									●	
		0.8	0.15-0.30	0.80-3.0																									●	
Semi-finishing	 CNMG 120404E-PB3 120408E-PB3 120412E-PB3	0.4	0.06-0.18	0.30-3.5	●		▲	▲																						
		0.8	0.12-0.36	0.60-3.5	●	●	▲	▲																						
		1.2	0.18-0.54	0.90-3.5	●	●	▲	▲																						
	 CNMG 120404E-PC3 120408E-PC3 120412E-PC3	0.4	0.07-0.20	0.34-3.9	●		▲	▲																						
		0.8	0.14-0.40	0.68-3.9	●		▲	▲																						
		1.2	0.20-0.60	1.02-3.9	●		▲	▲																						
Medium	 CNMG 120404E-PD3 120408E-PD3 120412E-PD3 160608E-PD3 160612E-PD3 190608E-PD3 190612E-PD3 190616E-PD3	0.4	0.08-0.22	0.40-4.3	●	●	▲	▲	●																					
		0.8	0.15-0.44	0.80-4.3	●	●	▲	▲	●																					
		1.2	0.23-0.66	1.20-4.3	●	●	▲	▲	●																					
		0.8	0.15-0.44	0.80-5.3		●	▲	▲	●																					
		1.2	0.23-0.66	1.20-5.3		●	▲	▲	●																					
		0.8	0.15-0.44	0.80-6.4		●	▲	▲	●																					
		1.2	0.23-0.66	1.20-6.4		●	▲	▲	●																					
		1.6	0.30-0.66	1.60-6.4		●	▲	▲	●																					

●: Stock available ▲: Stock available now but will be replaced in the future.

Negative 80° (C)

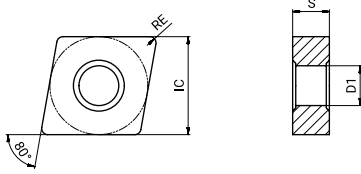

Dimension (mm)			
Product code	IC	S	D1
CN_1204_	12.7	4.76	5.16
CN_1606_	15.875	6.35	6.35
CN_1906_	19.05	6.35	7.94

Inserts	Product code	RE (mm)	Recommended parameters		Machining conditions															
			f (mm/rev)	ap (mm)	p					M			K			N	S			
					AT202	AC052P	AC150P	AC250P	AC350P	AC100M	AC200M	AP200U	AP301M	AC100K	AC102K	AC202K	AW100K	AP100S		
Medium		CNMG 120404E-SC3	0.4	0.08-0.22	0.40-4.3						●	●	●							●
		120408E-SC3	0.8	0.15-0.44	0.80-4.3						●	●	●							●
		120412E-SC3	1.2	0.23-0.66	1.20-4.3						●	●	●							●
		160612E-SC3	1.2	0.23-0.66	1.20-5.3						●	●	●							●
		160616E-SC3	1.6	0.30-0.88	1.60-5.3						●	●	●							●
		190612E-SC3	1.2	0.23-0.66	1.20-6.4						●	●	●							●
		190616E-SC3	1.6	0.30-0.88	1.60-6.4						●	●	●							●
		CNMG 120404E-MC3	0.4	0.08-0.22	0.32-4.3						●	●	●							
		120408E-MC3	0.8	0.15-0.44	0.64-4.3						●	●	●							●
		120412E-MC3	1.2	0.23-0.66	0.96-4.3						●	●	●							
		120416E-MC3	1.6	0.30-0.88	1.28-4.3						●	●	●							
		160608E-MC3	0.8	0.15-0.44	0.64-5.3						●	●	●							
		160612E-MC3	1.2	0.23-0.66	0.96-5.3						●	●	●							
		190608E-MC3	0.8	0.15-0.44	0.64-6.4						●	●	●							
	190612E-MC3	1.2	0.23-0.66	0.96-6.4						●	●	●								
		CNMG 120404E-PC4	0.4	0.08-0.22	0.40-4.3			▲	▲									●	●	
		120408E-PC4	0.8	0.15-0.44	0.80-4.3		●	▲	▲									●	●	
		120412E-PC4	1.2	0.23-0.66	1.20-4.3		●	▲	▲									●	●	
		160612E-PC4	1.2	0.23-0.66	1.20-5.3		●	▲	▲									●	●	
		160616E-PC4	1.6	0.30-0.88	1.60-5.3		●	▲	▲									●	●	
		190612E-PC4	1.2	0.23-0.66	1.20-6.4		●	▲	▲									●	●	
Roughing		CNMG 120408E-MC4	0.8	0.20-0.60	1.20-6.4						●	●	●						●	
		120412E-MC4	1.2	0.30-0.90	1.80-6.4						●	●	●						●	
		160612E-MC4	1.2	0.30-0.90	1.80-8.1						●	●	●						●	
		160616E-MC4	1.6	0.40-1.20	2.40-8.1						●	●	●							
		190612E-MC4	1.2	0.30-0.90	1.80-9.7						●	●	●							
		190616E-MC4	1.6	0.40-1.20	2.40-9.7						●	●	●							

●: Stock available ▲: Stock available now but will be replaced in the future.

Negative 80° (C)

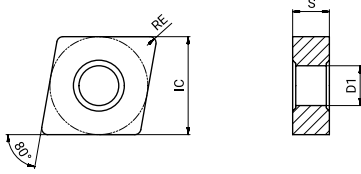

Dimension (mm)			
Product code	IC	S	D1
CN_0903_	9.525	3.18	3.81
CN_1204_	12.7	4.76	5.16
CN_1606_	15.875	6.35	6.35
CN_1906_	19.05	6.35	7.94



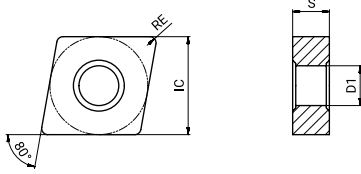

Inserts	Product code	RE (mm)	Recommended parameters		Machining conditions														
					● Good condition ● General condition ✖ Bad condition ● ● ● ● ● ● ● ● ● ● ● ● ● ● ● ●														
			f (mm/rev)	ap (mm)	p					M				K			N	S	
				AT202	AC052P	AC150P	AC250P	AC350P	AC100M	AC200M	AP200U	AP301M	AC100K	AC102K	AC202K	AW100K	AP100S		
	CNMG 090308E-KC4	0.8	0.18-0.48	0.96-3.9											●	●			
	120404E-KC4	0.4	0.09-0.24	0.48-5.2											●	●			
	120408E-KC4	0.8	0.18-0.48	0.96-5.2										●	●	●			
	120412E-KC4	1.2	0.26-0.72	1.44-5.2										●	●	●			
	120416E-KC4	1.6	0.35-0.96	1.92-5.2											●	●			
	160608E-KC4	0.8	0.18-0.48	0.96-6.4											●	●			
	160612E-KC4	1.2	0.26-0.72	1.44-6.4											●	●			
	160616E-KC4	1.6	0.35-0.96	1.92-6.4											●	●			
	190608E-KC4	0.8	0.18-0.48	0.96-7.7											●	●			
	190612E-KC4	1.2	0.26-0.72	1.44-7.7											●	●			
	190616E-KC4	1.6	0.35-0.96	1.92-7.7											●	●			
	190624E-KC4	2.4	0.53-1.44	2.88-7.7											●	●			
	CNMG 120408E-PD5	0.8	0.20-0.60	1.20-6.4		●	▲	▲	●										
	120412E-PD5	1.2	0.30-0.90	1.80-6.4		●	▲	▲	●										
	160612E-PD5	1.2	0.30-0.90	1.80-8.1		●	▲	▲	●										
	160616E-PD5	1.6	0.40-1.20	2.40-8.1		●	▲	▲	●										
	160624E-PD5	2.4	0.60-1.80	3.60-8.1		●	▲	▲											
	190612E-PD5	1.2	0.30-0.90	1.80-9.7		●	▲	▲	●										
	190616E-PD5	1.6	0.40-1.20	2.40-9.7		●	▲	▲	●										
	CNMA 120404E-KD5	0.4	0.10-0.30	0.60-6.4											●	●			
	120408E-KD5	0.8	0.20-0.60	1.20-6.4										●	●	●			
	120412E-KD5	1.2	0.30-0.90	1.80-6.4										●	●	●			
	120416E-KD5	1.6	0.40-1.20	2.40-6.4										●	●	●			
	160608E-KD5	0.8	0.20-0.60	1.20-8.1											●	●			
	160612E-KD5	1.2	0.30-0.90	1.80-8.1										●	●	●			
	160616E-KD5	1.6	0.40-1.20	2.40-8.1										●	●	●			
	160620E-KD5	2.0	0.50-1.50	3.00-8.1											●	●			
	190608E-KD5	0.8	0.20-0.60	1.20-9.7											●	●	●		
	190612E-KD5	1.2	0.30-0.90	1.80-9.7											●	●	●		
190616E-KD5	1.6	0.40-1.20	2.40-9.7											●	●	●			

●: Stock available ▲: Stock available now but will be replaced in the future.

Negative 80° (C)



Dimension (mm)			
Product code	IC	S	D1
CN_1204_	12.7	4.76	5.16
CN_1606_	15.875	6.35	6.35
CN_1906_	19.05	6.35	7.94
CN_2507_	25.4	7.94	9.12
CN_2509_	25.4	9.53	9.12





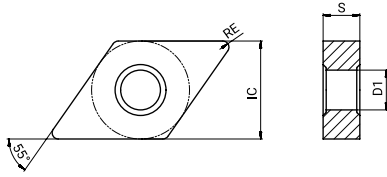

Inserts	Product code	RE (mm)	Recommended parameters		Machining conditions																
					● Good condition ◐ General condition ✖ Bad condition																
			f (mm/rev)	ap (mm)	p					M				K			N	S			
		AT202	AC052P	AC150P	AC250P	AC350P	AC100M	AC200M	AP200U	AP301M	AC100K	AC102K	AC202K	AW100K	AP100S						
Heavy roughing		CNMM 190616E-PC8	1.6	0.32-0.64	2.88-7.7	●															
		190624E-PC8	2.4	0.48-0.96	4.32-7.7	●			▲												
		CNMM 120408E-PD8	0.8	0.16-0.32	1.44-5.2		●	▲	▲	●											
		120412E-PD8	1.2	0.24-0.48	2.16-5.2		●	▲	▲	●											
		160612E-PD8	1.2	0.24-0.48	2.16-6.4		●	▲	▲	●											
		160616E-PD8	1.6	0.32-0.64	2.88-6.4		●	▲	▲	●											
		160624E-PD8	2.4	0.48-0.96	4.32-6.4		●	▲	▲	●											
		190612E-PD8	1.2	0.24-0.48	2.16-7.7		●	▲	▲	●											
		190616E-PD8	1.6	0.32-0.64	2.88-7.7		●	▲	▲	●											
		190624E-PD8	2.4	0.48-0.96	4.32-7.7		●	▲	▲	●											
		250724E-PD8	2.4	0.48-0.96	4.32-10.3		●	▲	▲	●											
		250924E-PD8	2.4	0.48-0.96	4.32-10.3		●	▲	▲	●											
		CNMM 190612S-PC9	1.2	0.26-0.60	2.40-9.7			▲	▲	●											
		190616S-PC9	1.6	0.35-0.80	3.20-9.7			▲	▲	●											
		190624S-PC9	2.4	0.53-1.20	4.80-9.7			▲	▲	●											
		250724S-PC9	2.4	0.53-1.20	4.80-12.9			▲	▲	●											
		250924S-PC9	2.4	0.53-1.20	4.80-12.9			▲	▲	●											
		CNMM 190612S-PD9	1.2	0.30-0.72	2.64-11.6			▲	▲	●											
		190616S-PD9	1.6	0.40-0.96	3.52-11.6			▲	▲	●											
		190624S-PD9	2.4	0.60-1.44	5.28-11.6			▲	▲	●											
250724S-PD9		2.4	0.60-1.44	5.28-15.5			▲	▲													
250924S-PD9		2.4	0.60-1.44	5.28-15.5			▲	▲	●												

●: Stock available ▲: Stock available now but will be replaced in the future.

Negative 55° (D)



Dimension (mm)			
Product code	IC	S	D1
DN_1104_	9.525	4.76	3.81
DN_1504_	12.7	4.76	5.16
DN_1506_	12.7	6.35	5.16



Inserts		Product code	RE (mm)	Recommended parameters		Machining conditions														
						p					M			K			N		S	
				f (mm/rev)	ap (mm)	●	●	●	⊕	⊕	●	⊕	⊕	⊕	●	⊕	⊕	⊕	●	
						AT202	AC052P	AC150P	AC250P	AC350P	AC100M	AC200M	AP200U	AP301M	AC100K	AC102K	AC202K	AW100K	AP100S	
Profiling		DNMG 110408E-BS	0.8	0.10-0.25	0.70-2.0		●													
Finishing		DNMG 110404E-PB1	0.4	0.05-0.15	0.26-2.3	●		▲	▲											
		150404E-PB1	0.4	0.05-0.15	0.26-3.1	●		▲	▲											
		150408E-PB1	0.8	0.10-0.30	0.52-3.1	●	●	▲	▲											
		150604E-PB1	0.4	0.05-0.15	0.26-3.1	●		▲	▲											
		150608E-PB1	0.8	0.10-0.30	0.52-3.1	●	●	▲	▲											
		DNMG 150404E-SC1	0.4	0.07-0.18	0.20-0.8								●							
		150408E-SC1	0.8	0.10-0.25	0.20-0.8								●							
		150604E-SC1	0.4	0.07-0.18	0.20-0.8								●							
		150608E-SC1	0.8	0.10-0.25	0.20-0.8								●							
		DNMG 150404E-MB2	0.4	0.05-0.15	0.26-2.9						●	●								●
		150408E-MB2	0.8	0.10-0.30	0.52-2.9						●	●								●
150604E-MB2		0.4	0.05-0.15	0.26-2.9						●	●								●	
150608E-MB2		0.8	0.10-0.30	0.52-2.9						●	●								●	
Light cutting		DNMG 110408E-SL3	0.8	0.12-0.30	0.80-2.5								●						●	
		150404E-SL3	0.4	0.12-0.25	0.60-2.5								●						●	
		150408E-SL3	0.8	0.12-0.30	0.80-2.5								●						●	
		150604E-SL3	0.4	0.12-0.25	0.60-2.5								●							●
		150608E-SL3	0.8	0.12-0.30	0.80-2.5								●							●
Semi-finishing		DNMG 150404R-M1T	0.4	0.10-0.35	0.70-4.5	●														
		150404L-M1T	0.4	0.10-0.35	0.70-4.5	●														
		DNMG 150404E-PB3	0.4	0.06-0.18	0.30-3.1	●		▲	▲											
		150408E-PB3	0.8	0.12-0.36	0.60-3.1	●	●	▲	▲											
		150412E-PB3	1.2	0.18-0.54	0.90-3.1	●	●	▲	▲											
		150604E-PB3	0.4	0.06-0.18	0.30-3.1	●		▲	▲											
		150608E-PB3	0.8	0.12-0.36	0.60-3.1	●	●	▲	▲											
150612E-PB3	1.2	0.18-0.54	0.90-3.1	●	●	▲	▲													

●: Stock available ▲: Stock available now but will be replaced in the future.

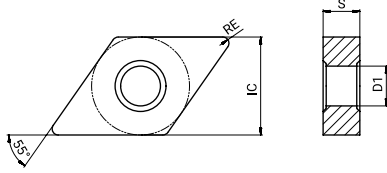
Negative 55° (D)



Dimension (mm)			
Product code	IC	S	D1
DN_1104_	9.525	4.76	3.81
DN_1504_	12.7	4.76	5.16
DN_1506_	12.7	6.35	5.16

Inserts	Product code	RE (mm)	Recommended parameters		Machining conditions																			
			f (mm/rev)	ap (mm)	p					M				K			N		S					
					AT202	AC052P	AC150P	AC250P	AC350P	AC100M	AC200M	AP200U	AP301M	AC100K	AC102K	AC202K	AW100K	AP100S						
Semi-finishing 	DNMG 110408E-PC3	0.8	0.14-0.40	0.68-2.6																				
	110412E-PC3	1.2	0.20-0.60	1.02-2.6																				
	150404E-PC3	0.4	0.07-0.20	0.34-3.5	●		▲	▲																
	150408E-PC3	0.8	0.14-0.40	0.68-3.5	●		▲	▲																
	150412E-PC3	1.2	0.20-0.60	1.02-3.5	●		▲	▲																
	150604E-PC3	0.4	0.07-0.20	0.34-3.5	●		▲	▲																
	150608E-PC3	0.8	0.14-0.40	0.68-3.5	●		▲	▲																
	150612E-PC3	1.2	0.20-0.60	1.02-3.5	●		▲	▲																
Medium  	DNMG 110404E-PD3	0.4	0.08-0.22	0.40-2.9	●		▲	▲																
	110408E-PD3	0.8	0.15-0.44	0.80-2.9	●	●	▲	▲																
	150404E-PD3	0.4	0.08-0.22	0.40-3.9	●		▲	▲																
	150408E-PD3	0.8	0.15-0.44	0.80-3.9	●	●	▲	▲	●															
	150412E-PD3	1.2	0.23-0.66	1.20-3.9		●	▲	▲	●															
	150604E-PD3	0.4	0.08-0.22	0.40-3.9			▲	▲																
	150608E-PD3	0.8	0.15-0.44	0.80-3.9		●	▲	▲	●															
	150612E-PD3	1.2	0.23-0.66	1.20-3.9		●	▲	▲	●															
	DNMG 150608R-PL5	0.8	0.15-0.44	0.80-3.9			▲	▲																
	DNMG 150404E-SC3	0.4	0.08-0.22	0.40-3.9						●	●	●												●
	150408E-SC3	0.8	0.15-0.44	0.80-3.9						●	●	●												●
	150412E-SC3	1.2	0.23-0.66	1.20-3.9						●	●	●												●
	150604E-SC3	0.4	0.08-0.22	0.40-3.9						●	●	●												●
	150608E-SC3	0.8	0.15-0.44	0.80-3.9						●	●	●												●
	150612E-SC3	1.2	0.23-0.66	1.20-3.9						●	●	●												●
	DNMG 110404E-MC3	0.4	0.08-0.22	0.32-2.9						●	●	●												
	110408E-MC3	0.8	0.15-0.44	0.64-2.9						●	●	●												
	150404E-MC3	0.4	0.08-0.22	0.32-3.9						●	●	●												
	150408E-MC3	0.8	0.15-0.44	0.64-3.9						●	●	●												
	150412E-MC3	1.2	0.23-0.66	0.96-3.9						●	●	●												
150604E-MC3	0.4	0.08-0.22	0.32-3.9						●	●	●													
150608E-MC3	0.8	0.15-0.44	0.64-3.9						●	●	●													
150612E-MC3	1.2	0.23-0.66	0.96-3.9						●	●	●													

●: Stock available ▲: Stock available now but will be replaced in the future.

Negative 55° (D)

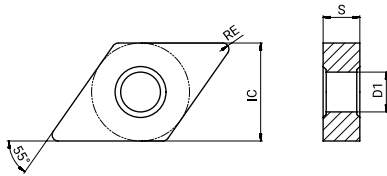

Dimension (mm)			
Product code	IC	S	D1
DN_1104_	9.525	4.76	3.81
DN_1504_	12.7	4.76	5.16
DN_1506_	12.7	6.35	5.16

Inserts	Product code	RE (mm)	Recommended parameters		Machining conditions																
			f (mm/rev)	ap (mm)	p					M				K			N	S			
					AT202	AC052P	AC150P	AC250P	AC350P	AC100M	AC200M	AP200U	AP301M	AC100K	AC102K	AC202K	AW100K	AP100S			
Medium	DNMG 150404E-PC4	0.4	0.08-0.22	0.40-3.9	●		▲	▲									●	●			
	150408E-PC4	0.8	0.15-0.44	0.80-3.9	●	●	▲	▲									●	●			
	150412E-PC4	1.2	0.23-0.66	1.20-3.9		●	▲	▲									●	●			
	150604E-PC4	0.4	0.08-0.22	0.40-3.9	●		▲	▲									●	●			
	150608E-PC4	0.8	0.15-0.44	0.80-3.9	●	●	▲	▲									●	●			
	150612E-PC4	1.2	0.23-0.66	1.20-3.9		●	▲	▲									●	●			
Roughing	DNMG 150408E-MC4	0.8	0.20-0.60	1.20-5.4						●	●	●									
	150412E-MC4	1.2	0.30-0.90	1.80-5.4						●	●	●									
	150608E-MC4	0.8	0.20-0.60	1.20-5.4						●	●	●								●	
	150612E-MC4	1.2	0.30-0.90	1.80-5.4						●	●	●								●	
	DNMG 110404E-KC4	0.4	0.09-0.24	0.48-3.5													●	●			
	110408E-KC4	0.8	0.18-0.48	0.96-3.5													●	●			
	150404E-KC4	0.4	0.09-0.24	0.48-4.6													●	●			
	150408E-KC4	0.8	0.18-0.48	0.96-4.6													●	●			
	150412E-KC4	1.2	0.26-0.72	1.44-4.6													●	●			
	150604E-KC4	0.4	0.09-0.24	0.48-4.6													●	●			
	150608E-KC4	0.8	0.18-0.48	0.96-4.6													●	●			
	150612E-KC4	1.2	0.26-0.72	1.44-4.6													●	●			
	DNMG 150408E-PD5	0.8	0.20-0.60	1.20-5.4		●	▲	▲	●												
	150412E-PD5	1.2	0.30-0.90	1.80-5.4		●	▲	▲	●												
	150416E-PD5	1.6	0.40-1.20	2.40-5.4		●	▲	▲													
	150608E-PD5	0.8	0.20-0.60	1.20-5.4		●	▲	▲	●												
	150612E-PD5	1.2	0.30-0.90	1.80-5.4		●	▲	▲	●												
	150616E-PD5	1.6	0.40-1.20	2.40-5.4		●	▲	▲	●												
	DNMA 150404E-KD5	0.4	0.10-0.30	0.60-5.4													●	●			
	150408E-KD5	0.8	0.20-0.60	1.20-5.4													●	●	●		
	150412E-KD5	1.2	0.30-0.90	1.80-5.4													●	●	●		
	150604E-KD5	0.4	0.10-0.30	0.60-5.4													●	●			
	150608E-KD5	0.8	0.20-0.60	1.20-5.4													●	●	●		
	150612E-KD5	1.2	0.30-0.90	1.80-5.4													●	●	●		

●: Stock available ▲: Stock available now but will be replaced in the future.

Negative 90° (S)

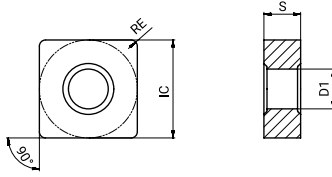

Dimension (mm)			
Product code	IC	S	D1
SN_1204_	12.7	4.76	5.16
SN_1506_	15.875	6.35	6.35
SN_1906_	19.05	6.35	7.94

Inserts	Product code	RE (mm)	Recommended parameters		Machining conditions																
			f (mm/rev)	ap (mm)	p					M				K			N	S			
					AT202	AC052P	AC150P	AC250P	AC350P	AC100M	AC200M	AP200U	AP301M	AC100K	AC102K	AC202K	AW100K	AP100S			
Finishing	SNMG 120404E-PB1	0.4	0.05-0.15	0.26-3.2	●		▲	▲													
	120408E-PB1	0.8	0.10-0.30	0.52-3.2	●	●	▲	▲													
	120412E-PB1	1.2	0.15-0.45	0.78-3.2		●	▲	▲													
Finishing	SNMG 120404E-MB2	0.4	0.05-0.15	0.26-3.2						●	●	●								●	
	120408E-MB2	0.8	0.10-0.30	0.52-3.2						●	●	●								●	
	120412E-MB2	1.2	0.15-0.45	0.78-3.2						●	●	●								●	
Light cutting	SNMG 120404E-SL3	0.4	0.12-0.25	0.60-3.0																●	
	120408E-SL3	0.8	0.15-0.30	0.80-3.0																●	
	120412E-SL3	1.2	0.18-0.35	1.00-3.0																●	
Semi-finishing	SNMG 120404E-PC3	0.4	0.07-0.20	0.34-3.8	●		▲	▲													
	120408E-PC3	0.8	0.14-0.40	0.68-3.8	●		▲	▲													
	120412E-PC3	1.2	0.20-0.60	1.02-3.8	●		▲	▲													
Medium	SNMG 120404E-PD3	0.4	0.08-0.22	0.40-4.2	●		▲	▲	●												
		0.8	0.15-0.44	0.80-4.2	●	●	▲	▲	●												
		1.2	0.23-0.66	1.20-4.2	●	●	▲	▲	●												
		0.8	0.15-0.44	0.80-6.3		●	▲	▲	●												
	SNMG 120408E-SC3	0.8	0.15-0.44	0.80-4.2						●	●	●									●
		1.2	0.23-0.66	1.20-4.2						●	●	●									●
		1.2	0.23-0.66	1.20-5.2						●	●	●									●
		1.6	0.30-0.88	1.60-5.2						●	●	●									●
		1.2	0.23-0.66	1.20-6.3						●	●	●									●
	SNMG 120404-M3T	0.4	0.20-0.40	1.0-4.0	●																
		0.8	0.20-0.40	1.0-4.0	●																
	SNMG 120404E-MC3	0.4	0.08-0.22	0.32-4.2						●	●	●									
		0.8	0.15-0.44	0.64-4.2						●	●	●									
		1.2	0.23-0.66	0.96-4.2						●	●	●									
		1.2	0.23-0.66	0.96-5.2						●	●	●									
1.6		0.30-0.88	1.28-5.2						●	●	●										
1.2		0.23-0.66	0.96-6.3						●	●	●										
1.6		0.30-0.88	1.28-6.3						●	●	●										

●: Stock available ▲: Stock available now but will be replaced in the future.

ISO Turning Insert

Negative 90° (S)

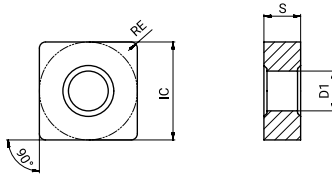

Dimension (mm)			
Product code	IC	S	D1
SN_0903_	9.525	3.18	3.81
SN_1204_	12.7	4.76	5.16
SN_1506_	15.875	6.35	6.35
SN_1906_	19.05	6.35	7.94

Inserts	Product code	RE (mm)	Recommended parameters		Machining conditions																
			f (mm/rev)	ap (mm)	p					M				K			N	S			
					AT202	AC052P	AC150P	AC250P	AC350P	AC100M	AC200M	AP200U	AP301M	AC100K	AC102K	AC202K	AW100K	AP100S			
Medium	SNMG 120404E-PC4	0.4	0.08-0.22	0.40-4.2	●		▲	▲													
	120408E-PC4	0.8	0.15-0.44	0.80-4.2	●	●	▲	▲							●	●	●				
	120412E-PC4	1.2	0.23-0.66	1.20-4.2	●	●	▲	▲							●	●	●				
Roughing	SNMG 120408E-MC4	0.8	0.20-0.60	1.20-6.4						●	●	●								●	
	120412E-MC4	1.2	0.30-0.90	1.80-6.4						●	●	●								●	
	150612E-MC4	1.2	0.30-0.90	1.80-7.9						●	●	●									
	150616E-MC4	1.6	0.40-1.20	2.40-7.9						●	●	●									
	190612E-MC4	1.2	0.30-0.90	1.80-9.5						●	●	●									
	190616E-MC4	1.6	0.40-1.20	2.40-9.5						●	●	●								●	
	SNMG 090304E-KC4	0.4	0.09-0.24	0.48-3.8																	
	090308E-KC4	0.8	0.18-0.48	0.96-3.8																	
	120404E-KC4	0.4	0.09-0.24	0.48-5.1																	
	120408E-KC4	0.8	0.18-0.48	0.96-5.1																	
	120412E-KC4	1.2	0.26-0.72	1.44-5.1																	
	150608E-KC4	0.8	0.18-0.48	0.96-6.4																	
	150612E-KC4	1.2	0.26-0.72	1.44-6.4																	
	150616E-KC4	1.6	0.35-0.96	1.92-6.4																	
	190608E-KC4	0.8	0.18-0.48	0.96-7.6																	
	190612E-KC4	1.2	0.26-0.72	1.44-7.6																	
	190616E-KC4	1.6	0.35-0.96	1.92-7.6																	
	190624E-KC4	2.4	0.53-1.44	2.88-7.6																	
	SNMG 150608E-PD5	0.8	0.20-0.60	1.20-7.9		●	▲	▲	●												
	150612E-PD5	1.2	0.30-0.90	1.80-7.9		●	▲	▲	●												
150616E-PD5	1.6	0.40-1.20	2.40-7.9		●	▲	▲	●													
190612E-PD5	1.2	0.30-0.90	1.80-9.5		●	▲	▲	●													
190616E-PD5	1.6	0.40-1.20	2.40-9.5		●	▲	▲	●													

●: Stock available ▲: Stock available now but will be replaced in the future.

Negative 90° (S)

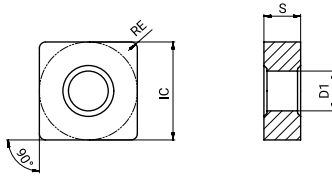

Dimension (mm)			
Product code	IC	S	D1
SN_1204_	12.7	4.76	5.16
SN_1506_	15.875	6.35	6.35
SN_1906_	19.05	6.35	7.94
SN_2507_	25.4	7.94	9.12
SN_2509_	25.4	9.52	9.12
SN_3109_	31.75	9.52	9.45

Inserts	Product code	RE (mm)	Recommended parameters		Machining conditions																		
			f (mm/rev)	ap (mm)	p					M				K			N	S					
					AT202	AC052P	AC150P	AC250P	AC350P	AC100M	AC200M	AP200U	AP301M	AC100K	AC102K	AC202K	AW100K	AP100S					
Roughing	SNMA 120408E-KD5	0.8	0.20-0.60	1.20-6.4													●	●	●				
	120412E-KD5	1.2	0.30-0.90	1.80-6.4													●	●	●				
	120416E-KD5	1.6	0.40-1.20	2.40-6.4													●	●	●				
	150612E-KD5	1.2	0.30-0.90	1.80-7.9														●	●				
	150616E-KD5	1.6	0.40-1.20	2.40-7.9														●	●				
	190612E-KD5	1.2	0.30-0.90	1.80-9.5														●	●				
	190616E-KD5	1.6	0.40-1.20	2.40-9.5														●	●				
Heavy roughing	SNMM120408E-PD8	0.8	0.16-0.32	1.44-5.1			▲	▲	●														
	120412E-PD8	1.2	0.24-0.48	2.16-5.1			▲	▲	●														
	150612E-PD8	1.2	0.24-0.48	2.16-6.4			▲	▲	●														
	150616E-PD8	1.6	0.32-0.64	2.88-6.4		●	▲	▲	●														
	190612E-PD8	1.2	0.24-0.48	2.16-7.6			▲	▲	●														
	190616E-PD8	1.6	0.32-0.64	2.88-7.6		●	▲	▲	●														
	190624E-PD8	2.4	0.48-0.96	4.32-7.6		●	▲	▲	●														
	250724E-PD8	2.4	0.48-0.96	4.32-10.2			▲	▲	●														
	250924E-PD8	2.4	0.48-0.96	4.32-10.2			▲	▲	●														
	SNMM190612S-PC9	1.2	0.26-0.60	2.40-9.5			▲	▲															
	190616S-PC9	1.6	0.35-0.80	3.20-9.5			▲	▲	●														
	190624S-PC9	2.4	0.53-1.20	4.80-9.5			▲	▲	●														
	250724S-PC9	2.4	0.53-1.20	4.80-12.7			▲	▲	●														
	250924S-PC9	2.4	0.53-1.20	4.80-12.7			▲	▲	●														
	SNMH 310924S-PC9	2.4	0.53-1.20	4.80-15.9				▲	●														
	SNMM190612S-PD9	1.2	0.30-0.72	2.64-11.4			▲	▲	●														
	190616S-PD9	1.6	0.40-0.96	3.52-11.4			▲	▲	●														
190624S-PD9	2.4	0.60-1.44	5.28-11.4			▲	▲	●															
250724S-PD9	2.4	0.60-1.44	5.28-15.2			▲	▲	●															
250924S-PD9	2.4	0.60-1.44	5.28-15.2			▲	▲	●															
SNMX 310924S-PD9	2.4	0.60-1.44	5.28-19.1				▲	●															

●: Stock available ▲: Stock available now but will be replaced in the future.

Negative 60° (T)

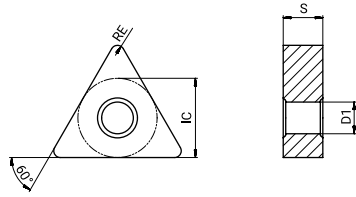

Dimension (mm)			
Product code	IC	S	D1
TN_1103_	6.35	3.18	2.26
TN_1604_	9.525	4.76	3.81
TN_2204_	12.7	4.76	5.16

Inserts	Product code	RE (mm)	Recommended parameters		Machining conditions															
					● Good condition ● General condition ✖ Bad condition															
			f (mm/rev)	ap (mm)	p					M				K			N	S		
		AT202	AC052P	AC150P	AC250P	AC350P	AC100M	AC200M	AP200U	AP301M	AC100K	AC102K	AC202K	AW100K	AP100S					
Finishing		TNMG 160404E-PB1	0.4	0.05-0.15	0.26-3.1	●		▲	▲											
		160408E-PB1	0.8	0.10-0.30	0.52-3.1	●	●	▲	▲											
		160412E-PB1	1.2	0.15-0.45	0.78-3.1	●	●	▲	▲											
		TNMG 160404E-SC1	0.4	0.07-0.18	0.20-0.8						●									
		160408E-SC1	0.8	0.10-0.25	0.20-0.8						●									
		TNMG 160404E-MB2	0.4	0.05-0.15	0.26-3.1					●	●	●				●				
160408E-MB2	0.8	0.10-0.30	0.52-3.1					●	●	●				●						
Light cutting		TNMG 160404E-SL3	0.4	0.12-0.25	0.60-3.0						●				●					
		160408E-SL3	0.8	0.15-0.30	0.80-3.0						●				●					
		160412E-SL3	1.2	0.18-0.30	1.00-3.0						●				●					
Semi-finishing		TNMG 160404R-M1T	0.4	0.10-0.30	0.10-0.30	●														
		160404L-M1T	0.4	0.10-0.30	0.10-0.30	●														
		TNMG 160404E-PB3	0.4	0.06-0.18	0.30-3.3	●		▲	▲											
		160408E-PB3	0.8	0.12-0.36	0.60-3.3	●	●	▲	▲											
		160412E-PB3	1.2	0.18-0.54	0.90-3.3	●	●	▲	▲											
		TNMG 160404E-PC3	0.4	0.07-0.20	0.34-3.7	●		▲	▲											
		160408E-PC3	0.8	0.14-0.40	0.68-3.7	●		▲	▲											
		160412E-PC3	1.2	0.20-0.60	1.02-3.7	●		▲	▲											
	Medium		TNMG 160404E-PD3	0.4	0.08-0.22	0.40-4.1	●		▲	▲	●									
160408E-PD3			0.8	0.15-0.44	0.80-4.1	●	●	▲	▲	●										
160412E-PD3			1.2	0.23-0.66	1.20-4.1	●	●	▲	▲	●										
		TNMG 160404R-M2T	0.4	0.10-0.30	0.70-3.5	●														
		160404L-M2T	0.4	0.10-0.30	0.70-3.5	●														
		TNMG 160404R-PL5	0.4	0.08-0.22	0.40-4.1	●		▲	▲											
		160408R-PL5	0.8	0.15-0.44	0.80-4.1	●	●	▲	▲											
		160404L-PL5	0.4	0.08-0.22	0.40-4.1	●		▲	▲											
		160408L-PL5	0.8	0.15-0.44	0.80-4.1	●	●	▲	▲											
		TNMG 160404E-SC3	0.4	0.08-0.22	0.40-4.1					●	●	●			●					
		160408E-SC3	0.8	0.15-0.44	0.80-4.1					●	●	●			●					
		160412E-SC3	1.2	0.23-0.66	1.20-4.1					●	●	●			●					

● : Stock available ▲ : Stock available now but will be replaced in the future.

Negative 60° (T)

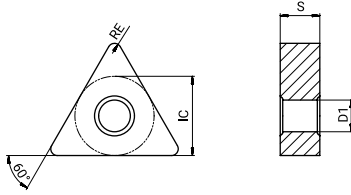

Dimension (mm)			
Product code	IC	S	D1
TN_1103_	6.35	3.18	2.26
TN_1604_	9.525	4.76	3.81
TN_2204_	12.7	4.76	5.16

Inserts	Product code	RE (mm)	Recommended parameters		Machining conditions																
			f (mm/rev)	ap (mm)	p					M				K			N	S			
					AT202	AC052P	AC150P	AC250P	AC350P	AC100M	AC200M	AP200U	AP301M	AC100K	AC102K	AC202K	AW100K	AP100S			
Medium	TNMG 160404E-MC3	0.4	0.08-0.22	0.32-4.1							●	●	●								
	160408E-MC3	0.8	0.15-0.44	0.64-4.1							●	●	●								
	160412E-MC3	1.2	0.23-0.66	0.96-4.1							●	●	●								
	220408E-MC3	0.8	0.15-0.44	0.64-4.9							●	●	●							●	
	220412E-MC3	1.2	0.23-0.66	0.96-4.9							●	●	●								
	TNMG 160404E-PC4	0.4	0.08-0.22	0.40-4.1	●		▲	▲													
	160408E-PC4	0.8	0.15-0.44	0.80-4.1	●	●	▲	▲													
	160412E-PC4	1.2	0.23-0.66	1.20-4.1		●	▲	▲													
220412E-PC4	1.2	0.23-0.66	1.20-4.9			▲	▲														
Roughing	TNMG 160408E-MC4	0.8	0.20-0.60	1.20-5.8							●	●	●							●	
	160412E-MC4	1.2	0.30-0.90	1.80-5.8							●	●	●							●	
	220408E-MC4	0.8	0.20-0.60	1.20-6.6							●	●	●								
	220412E-MC4	1.2	0.30-0.90	1.80-6.6							●	●	●								
	TNMG 110304E-KC4	0.4	0.09-0.24	0.48-3.3														●	●		
	160404E-KC4	0.4	0.09-0.24	0.48-4.9														●	●		
	160408E-KC4	0.8	0.18-0.48	0.96-4.9											●		●	●			
	160412E-KC4	1.2	0.26-0.72	1.44-4.9											●		●	●			
	160416E-KC4	1.6	0.35-0.96	1.92-4.9													●	●			
	220412E-KC4	1.2	0.26-0.72	1.44-6.0													●	●			
	220416E-KC4	1.6	0.35-0.96	1.92-6.0													●	●			
	TNMG 160408E-PD5	0.8	0.20-0.60	1.20-5.8		●	▲	▲	●												
	160412E-PD5	1.2	0.30-0.90	1.80-5.8		●	▲	▲	●												
	220408E-PD5	0.8	0.20-0.60	1.20-7.7		●	▲	▲	●												
	220412E-PD5	1.2	0.30-0.90	1.80-7.7		●	▲	▲	●												
	220416E-PD5	1.6	0.40-1.20	2.40-7.7		●	▲	▲	●												

●: Stock available ▲: Stock available now but will be replaced in the future.

Negative 60° (T)

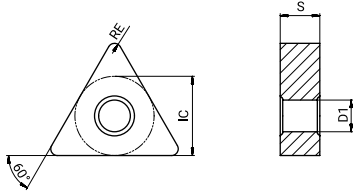

Dimension (mm)			
Product code	IC	S	D1
TN_1103_	6.35	3.18	2.26
TN_1604_	9.525	4.76	3.81
TN_2204_	12.7	4.76	5.16





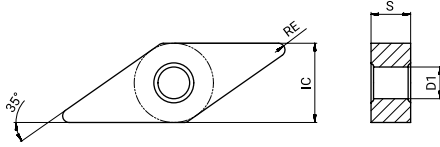

Inserts Left-hand shown where it's applicable		Product code	RE (mm)	Recommended parameters f (mm/rev) ap (mm)		Machining conditions																	
						● Good condition ● General condition ✖ Bad condition																	
						p					M			K			N		S				
						AT202	AC052P	AC150P	AC250P	AC350P	AC100M	AC200M	AP200U	AP301M	AC100K	AC102K	AC202K	AW100K	AP100S				
Roughing		TNMA 160404E-KD5	0.4	0.10-0.30	0.60-5.8																		
		160408E-KD5	0.8	0.20-0.60	1.20-5.8																		
		160412E-KD5	1.2	0.30-0.90	1.80-5.8												●	●	●				
		160416E-KD5	1.6	0.40-1.20	2.40-5.8												●	●	●				
		220408E-KD5	0.8	0.20-0.60	1.20-7.7														●	●			
		220412E-KD5	1.2	0.30-0.90	1.80-7.7														●	●			
		220416E-KD5	1.6	0.40-1.20	2.40-7.7														●	●			
Heavy roughing		TNMM160408E-PD8	0.8	0.16-0.32	1.44-4.9				▲														
		160412E-PD8	1.2	0.24-0.48	2.16-4.9				▲														
		220408E-PD8	0.8	0.16-0.32	1.44-6.0				▲														
		220412E-PD8	1.2	0.24-0.48	2.16-6.0				▲														
		220416E-PD8	1.6	0.32-0.64	2.88-6.0				▲														
Finishing		TNGG 160401FP-UF	0.1	0.03-0.11	0.3-2.5										●								
		160402FP-UF	0.2	0.03-0.11	0.3-2.5											●							
		160404FP-UF	0.4	0.03-0.11	0.3-2.5												●						
		TNGG 160402FR-F	0.2	0.08-0.20	0.5-2.3											●							
		160402FL-F	0.2	0.08-0.20	0.5-2.3												●						
		160404FR-F	0.4	0.08-0.20	0.5-2.3												●						
		160404FL-F	0.4	0.08-0.20	0.5-2.3												●						
		Semi-finishing-Roughing		TNGG 160404R-H	0.4	0.22-0.38	1.2-3.8											●					
160404L-H	0.4			0.22-0.38	1.2-3.8												●						
160408R-H	0.8			0.22-0.38	1.2-3.8													●					
160408L-H	0.8			0.22-0.38	1.2-3.8													●					

●: Stock available ▲: Stock available now but will be replaced in the future.

Negative 35° (V)

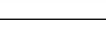

Dimension (mm)			
Product code	IC	S	D1
VN_1604_	9.525	4.76	3.81

Inserts	Product code	RE (mm)	Recommended parameters		Machining conditions																					
			f (mm/rev)	ap (mm)	p				M				K				N	S								
					AT202	AC052P	AC150P	AC250P	AC350P	AC100M	AC200M	AP200U	AP301M	AC100K	AC102K	AC202K	AW100K	AP100S								
Finishing	 VNMG 160404E-PB1 160408E-PB1	0.4	0.05-0.15	0.26-2.1	●		▲	▲																		
		0.8	0.10-0.30	0.52-2.1	●	●	▲	▲																		
	 VNMG 160404E-SC1 160408E-SC1	0.4	0.10-0.25	0.20-0.8										●												
		0.8	0.15-0.30	0.20-0.8										●												
	 VNMG 160404E-MB2 160408E-MB2	0.4	0.05-0.15	0.26-2.1							●	●	●											●		
		0.8	0.10-0.30	0.52-2.1							●	●	●											●		
Light cutting	 VNMG 160404E-SL3 160408E-SL3	0.4	0.10-0.20	0.60-2.5									●										●			
		0.8	0.12-0.25	0.80-2.5										●										●		
Profiling	 VNMG 160404E-BS 160408E-BS	0.4	0.08-0.20	0.20-2.0	●	●																				
		0.8	0.08-0.20	0.20-2.0	●	●																				
Semi-finishing	 VNMG 160404E-PB3 160408E-PB3 160412E-PB3	0.4	0.06-0.18	0.30-3.1	●		▲	▲																		
		0.8	0.12-0.36	0.60-3.1	●	●	▲	▲																		
		1.2	0.18-0.54	0.90-3.1	●	●	▲	▲																		
	 VNMG 160404E-PC3 160408E-PC3 160412E-PC3	0.4	0.07-0.20	0.34-3.3	●		▲	▲																		
		0.8	0.14-0.40	0.68-3.3	●		▲	▲																		
		1.2	0.20-0.60	1.02-3.3	●		▲	▲																		





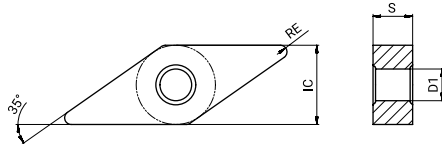

●: Stock available ▲: Stock available now but will be replaced in the future.

ISO Turning Insert

Negative 35° (V)



Dimension (mm)			
Product code	IC	S	D1
VN_1604_	9.525	4.76	3.81

Inserts	Product code	RE (mm)	Recommended parameters		Machining conditions																		
			f (mm/rev)	ap (mm)	p					M				K			N	S					
					AT202	AC052P	AC150P	AC250P	AC350P	AC100M	AC200M	AP200U	AP301M	AC100K	AC102K	AC202K	AW100K	AP100S					
Medium	 VNMG 160404E-PD3 160408E-PD3 160412E-PD3	0.4	0.08-0.22	0.40-3.3	●		▲	▲															
		0.8	0.15-0.44	0.80-3.3	●	●	▲	▲	●														
		1.2	0.23-0.66	1.20-3.3	●	●	▲	▲	●														
	 VNMG 160404-M3T 160408-M3T	0.4	0.20-0.40	1.0-4.0	●																		
		0.8	0.20-0.40	1.0-4.0	●																		
	 VNMG 160404E-SC3 160408E-SC3 160412E-SC3	0.4	0.08-0.22	0.40-3.3							●	●	●									●	
		0.8	0.15-0.44	0.80-3.3							●	●	●									●	
		1.2	0.23-0.66	1.20-3.3							●	●	●									●	
	 VNMG 160404E-MC3 160408E-MC3	0.4	0.08-0.22	0.32-3.3							●	●	●										
		0.8	0.15-0.44	0.64-3.3							●	●	●										
	 VNMG 160404E-PC4 160408E-PC4 160412E-PC4	0.4	0.08-0.22	0.40-3.3	●		▲	▲												●	●		
0.8		0.15-0.44	0.80-3.3	●	●	▲	▲													●	●		
1.2		0.23-0.66	1.20-3.3	●	●	▲	▲													●	●		
Roughing	 VNMG 160404E-KC4 160408E-KC4 160412E-KC4	0.4	0.09-0.24	0.48-3.3																	●	●	
		0.8	0.18-0.48	0.96-3.3																		●	●
		1.2	0.26-0.72	1.44-3.3																		●	●
Finishing	 VNGG 160401FP-UF 160402FP-UF 160404FP-UF	0.1	0.02-0.1	0.5-2.0																	●		
		0.2	0.02-0.1	0.5-2.0																		●	
		0.4	0.02-0.1	0.5-2.0																		●	

●: Stock available ▲: Stock available now but will be replaced in the future.

Negative 80° (W)

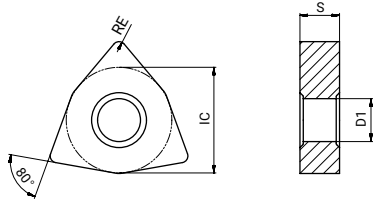

Dimension (mm)			
Product code	IC	S	D1
WN_0604_	9.525	4.76	3.81
WN_0804_	12.7	4.76	5.16

Inserts	Product code	RE (mm)	Recommended parameters		Machining conditions																
			f (mm/rev)	ap (mm)	p					M				K			N	S			
					AT202	AC052P	AC150P	AC250P	AC350P	AC100M	AC200M	AP200U	AP301M	AC100K	AC102K	AC202K	AW100K	AP100S			
Finishing	 WNUMG 080404-F1T 080408-F1T	0.4	0.05-0.15	0.50-2.5	●																
		0.8	0.05-0.15	0.50-2.5	●																
	 WNUMG 080404-PB1 080408E-PB1 080412E-PB1	0.4	0.05-0.15	0.26-2.2	●		▲	▲													
		0.8	0.10-0.30	0.52-2.2	●	●	▲	▲													
		1.2	0.15-0.45	0.78-2.2	●	●	▲	▲													
	 WNUMG 080404-SC1 080408E-SC1	0.4	0.10-0.25	0.20-0.8								●									
		0.8	0.15-0.30	0.20-0.8								●									
	 WNUMG 080404-MB2 080408E-MB2	0.4	0.05-0.15	0.26-2.2						●	●									●	
0.8		0.10-0.30	0.52-2.2						●	●									●		
Light cutting	 WNUMG 060404E-SL3 060408E-SL3 080404E-SL3 080408E-SL3 080412E-SL3	0.4	0.12-0.25	0.60-2.5									●							●	
		0.8	0.15-0.25	0.80-2.5										●							●
		0.4	0.12-0.25	0.60-3.0										●							●
		0.8	0.15-0.25	0.80-3.0										●							●
		1.2	0.18-0.30	1.00-3.0										●							●
Semi-finishing	 WNUMG 080404E-PB3 080408E-PB3 080412E-PB3	0.4	0.06-0.18	0.30-2.3	●		▲	▲													
		0.8	0.12-0.36	0.60-2.3	●	●	▲	▲													
		1.2	0.18-0.54	0.90-2.3	●	●	▲	▲													
	 WNUMG 080404E-PC3 080408E-PC3 080412E-PC3	0.4	0.07-0.20	0.34-2.6	●		▲	▲													
		0.8	0.14-0.40	0.68-2.6	●		▲	▲													
		1.2	0.20-0.60	1.02-2.6	●		▲	▲													

●: Stock available ▲: Stock available now but will be replaced in the future.

ISO Turning Insert

Negative 80° (W)

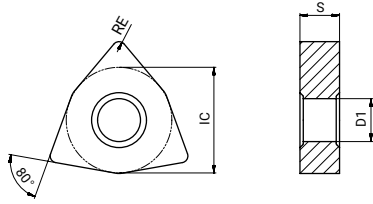

Dimension (mm)			
Product code	IC	S	D1
WN_0604_	9.525	4.76	3.81
WN_0804_	12.7	4.76	5.16



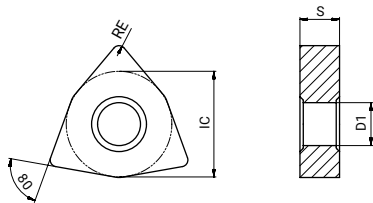

Inserts	Product code	RE (mm)	Recommended parameters		Machining conditions															
			f (mm/rev)	ap (mm)	p					M			K			N		S		
					AT202	AC052P	AC150P	AC250P	AC350P	AC100M	AC200M	AP200U	AP301M	AC100K	AC102K	AC202K	AW100K	AP100S		
Medium	WNMG 080404R-PL5	0.4	0.20-0.50	0.40-4.0				▲												
	080404L-PL5	0.4	0.20-0.50	0.40-4.0				▲												
	080408R-PL5	0.8	0.20-0.50	0.40-5.0				▲					●							
	080408L-PL5	0.8	0.20-0.50	0.40-5.0				▲					●							
	WNMG 060408E-PD3	0.8	0.15-0.44	0.80-2.1		●	▲	▲												
	080404E-PD3	0.4	0.08-0.22	0.40-2.9	●	●	▲	▲	●											
	080408E-PD3	0.8	0.15-0.44	0.80-2.9	●	●	▲	▲	●											
	080412E-PD3	1.2	0.23-0.66	1.20-2.9	●	●	▲	▲	●											
	WNMG 080404E-SC3	0.4	0.08-0.22	0.40-2.9						●	●	●								●
	080408E-SC3	0.8	0.15-0.44	0.80-2.9						●	●	●								●
	080412E-SC3	1.2	0.23-0.66	1.20-2.9						●	●	●								●
	WNMG 080404-M3T	0.4	0.20-0.40	1.0-4.0	●															
	080408-M3T	0.8	0.20-0.40	1.0-4.0	●															
	WNMG 060408E-MC3	0.8	0.15-0.44	0.64-2.1						●	●	●								
	060412E-MC3	1.2	0.23-0.66	0.96-2.1						●	●	●								
	080404E-MC3	0.4	0.08-0.22	0.32-2.9						●	●	●								
	080408E-MC3	0.8	0.15-0.44	0.64-2.9						●	●	●								●
	080412E-MC3	1.2	0.23-0.66	0.96-2.9						●	●	●								
	WNMG 080404E-PC4	0.4	0.08-0.22	0.40-2.9	●		▲	▲									●	●		
	080408E-PC4	0.8	0.15-0.44	0.80-2.9	●	●	▲	▲								●	●			
080412E-PC4	1.2	0.23-0.66	1.20-2.9	●	●	▲	▲								●	●				

●: Stock available ▲: Stock available now but will be replaced in the future.

Negative 80° (W)



Dimension (mm)			
Product code	IC	S	D1
WN_0604_	9.525	4.76	3.81
WN_0804_	12.7	4.76	5.16

Inserts	Product code	RE (mm)	f (mm/rev)	ap (mm)	Machining conditions												
					● Good condition ● General condition ✖ Bad condition ● ● ● ● ✖ ● ● ● ● ● ✖ ● ● ●												
					Recommended parameters					P			M			K	
			AT202	AC052P	AC150P	AC250P	AC350P	AC100M	AC200M	AP200U	AP301M	AC100K	AC102K	AC202K	AW100K	AP100S	
Roughing		WNMG 060408E-MC4	0.8	0.20-0.60	1.20-3.3												
		060412E-MC4	1.2	0.30-0.90	1.80-3.3					●	●	●					
		080408E-MC4	0.8	0.20-0.60	1.20-4.3					●	●	●				●	
		080412E-MC4	1.2	0.30-0.90	1.80-4.3					●	●	●				●	
		WNMG 060404E-KC4	0.4	0.09-0.24	0.48-2.6								●	●			
		060408E-KC4	0.8	0.18-0.48	0.96-2.6								●	●			
		080404E-KC4	0.4	0.09-0.24	0.48-3.5								●	●			
		080408E-KC4	0.8	0.18-0.48	0.96-3.5								●	●	●		
		080412E-KC4	1.2	0.26-0.72	1.44-3.5								●	●	●		
		080416E-KC4	1.2	0.35-0.96	1.92-3.5									●	●		
		WNMG 080408E-PD5	0.8	0.20-0.60	1.20-4.3		●	▲	▲	●							
		080412E-PD5	1.2	0.30-0.90	1.80-4.3		●	▲	▲	●							
		WNMA 080404E-KD5	0.4	0.10-0.30	0.60-4.3									●	●		
		080408E-KD5	0.8	0.20-0.60	1.20-4.3								●	●	●		
		080412E-KD5	1.2	0.30-0.90	1.80-4.3								●	●	●		
		080416E-KD5	1.6	0.40-1.20	2.40-4.3									●	●		

●: Stock available ▲: Stock available now but will be replaced in the future.

Negative 90° (L)

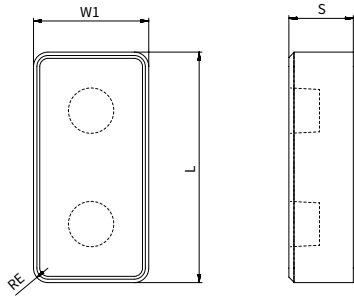

Dimension (mm)			
Product code	L	S	W1
LN_5014_	50.8	14.2	25.4



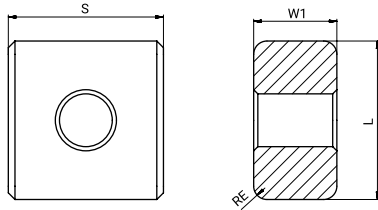

Inserts	Product code	RE (mm)	Recommended parameters		Machining conditions													
			f (mm/rev)	ap (mm)	● Good condition		⊕ General condition		⊗ Bad condition		● Good condition		⊕ General condition		⊗ Bad condition			
					●	⊕	⊗	●	⊕	⊗	●	⊕	⊗	●	⊕	⊗		
					p				M				K		N	S		
					AC052P	AC150P	AC250P	AC350P	AC100M	AC200M	AP200U	AP301M	AC100K	AC102K	AC202K	AW100K	AP100S	
Heavy roughing 	LNMX 501432S-HE	3.2	0.70-1.6	6.0-40.0				●										

●: Stock available ▲: Stock available now but will be replaced in the future.

Negative 90° (L)
Railway wheel re-turning

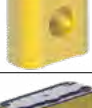

Dimension (mm)			
Product code	L	S	W1
LN_1919_	19.05	19.05	10
LN_3019_	30	30	12



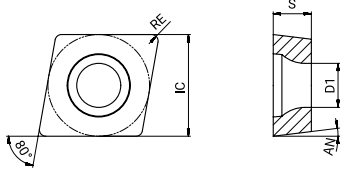

Inserts	Product code	RE (mm)	Recommended parameters f (mm/rev) ap (mm)		Machining conditions														
					● Good condition			⊕ General condition			⊖ Bad condition								
					●	⊕	⊖	●	⊕	⊖	●	⊕	⊖	●	⊕	⊖			
					p				M				K			N	S		
					AC052P	AC150P	AC250P	AC350P	AC100M	AC200M	AP200U	AP301M	AC100K	AC102K	AC202K	AW100K	AP100S		
Finishing	 LNMX 191940-AS	4.0	0.7-1.2	2.0-10.0															
Medium	 LNMX 191940-AM	4.0	0.7-1.2	2.0-10.0	●														
	 LNMX 301940-AM	4.0	0.7-1.2	2.0-20.0															
	 LNMX 301940-AR	4.0	0.7-1.2	2.0-20.0															

●: Stock available ▲: Stock available now but will be replaced in the future.

Positive 80° (C)



Dimension (mm)				
Product code	IC	S	D1	AN
CC_0602_	6.35	2.38	2.8	7°
CC_09T3_	9.525	3.97	4.4	7°

Inserts		Product code	RE (mm)	Recommended parameters		Machining conditions																						
				f (mm/rev)	ap (mm)	p					M			K			N	S										
						AT202	AC052P	AC150P	AC250P	AC350P	AC100M	AC200M	AP200U	AP301M	AC100K	AC102K	AC202K	AW100K	AP100S									
Finishing		CCGT 060201FP-LF	<0.1	0.05-0.2	0.35-3.0										●													
		060202FP-LF	0.2	0.05-0.2	0.35-3.0										●													
		060204FP-LF	0.4	0.05-0.2	0.35-3.0										●													
		09T301FP-LF	<0.1	0.05-0.2	0.35-3.0										●													
		09T302FP-LF	0.2	0.05-0.2	0.35-3.0										●													
		09T304FP-LF	0.4	0.05-0.2	0.35-3.0										●													
		CCGT 060201FP-UF	0.1	0.02-0.15	0.10-1.4										●													
		060202FP-UF	0.2	0.02-0.15	0.10-1.4										●													
		060204FP-UF	0.4	0.03-0.20	0.10-1.4										●													
		09T301FP-UF	0.1	0.02-0.15	0.10-2.4										●													
		09T302FP-UF	0.2	0.02-0.15	0.10-2.4										●													
		09T304FP-UF	0.4	0.03-0.20	0.10-2.4										●													
		CCGT 060201F-UF	0.1	0.02-0.15	0.10-1.4										▲													
		060202F-UF	0.2	0.02-0.15	0.10-1.4										▲													
		060204F-UF	0.4	0.03-0.20	0.10-1.4										▲													
		09T301F-UF	0.1	0.02-0.15	0.10-2.4										▲													
		09T302F-UF	0.2	0.02-0.15	0.10-2.4										▲													
		09T304F-UF	0.4	0.03-0.20	0.10-2.4										▲													
		09T308F-UF	0.8	0.03-0.25	0.10-2.4										▲													
		CCGT 060201E-UF	0.1	0.02-0.15	0.10-1.4										●												●	
		060202E-UF	0.2	0.02-0.15	0.10-1.4										●												●	
		060204E-UF	0.4	0.03-0.20	0.10-1.4										●												●	
		09T301E-UF	0.1	0.02-0.15	0.10-2.4										●												●	
		09T302E-UF	0.2	0.02-0.15	0.10-2.4										●												●	
09T304E-UF		0.4	0.03-0.20	0.10-2.4										●												●		
09T308E-UF		0.8	0.03-0.25	0.10-2.4										●												●		

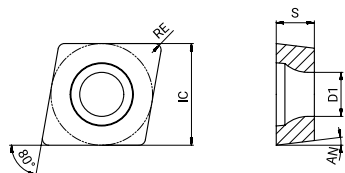

●: Stock available ▲: Stock available now but will be replaced in the future.

Positive 80° (C)



Dimension (mm)				
Product code	IC	S	D1	AN
CC_0602_	6.35	2.38	2.8	7°
CC_09T3_	9.525	3.97	4.4	7°
CC_1204_	12.7	4.76	5.5	7°
CP_0802_	7.94	2.38	3.4	11°
CP_0903_	9.525	3.18	4.4	11°

ISO Turning Insert



Inserts		Product code	RE (mm)	Recommended parameters		Machining conditions													
				f (mm/rev)	ap (mm)	● Good condition ● General condition ● Bad condition ● ● ● ● ● ● ● ● ● ● ● ● ● ● ● ● ● ●													
						p				M				K				N	
				AT202	AC052P	AC150P	AC250P	AC350P	AC100M	AC200M	AP200U	AP301M	AC100K	AC102K	AC202K	AW100K	AP100S		
Semi-Finishing		CCGT 060204F-NC2	0.4	0.05-0.20	0.32-2.9													●	
		09T302F-NC2	0.2	0.02-0.10	0.16-4.4													●	
		09T304F-NC2	0.4	0.05-0.20	0.32-4.4													●	
		09T308F-NC2	0.8	0.10-0.40	0.64-4.4													●	
		120404F-NC2	0.4	0.05-0.20	0.32-5.8													●	
		120408F-NC2	0.8	0.10-0.40	0.64-5.8													●	
Finishing		CCMT 060202-F1T	0.2	0.05-0.15	0.3-1.5	●													
		060204-F1T	0.4	0.05-0.15	0.3-1.5	●													
		CCMT 060202E-PB1	0.2	0.02-0.07	0.15-1.6	●		▲	▲		●	●	●						
		060204E-PB1	0.4	0.04-0.14	0.30-1.6	●		▲	▲		●	●	●						
		060208E-PB1	0.8	0.09-0.28	0.60-1.6	●		▲	▲		●	●	●						
		09T302E-PB1	0.2	0.02-0.07	0.15-2.4	●		▲	▲		●	●	●						
		09T304E-PB1	0.4	0.04-0.14	0.30-2.4	●		▲	▲		●	●	●					●	
		09T308E-PB1	0.8	0.09-0.28	0.60-2.4	●		▲	▲		●	●	●						
		CPMT 080202E-PB1	0.2	0.02-0.07	0.15-2.0	●													
		080204E-PB1	0.4	0.04-0.14	0.30-2.0	●													
		090302E-PB1	0.2	0.02-0.07	0.15-2.4	●													
		090304E-PB1	0.4	0.04-0.14	0.30-2.4	●			▲										
	090308E-PB1	0.8	0.09-0.28	0.60-2.4	●			▲											
Semi-Finishing		CCMT 060204E-PC2	0.4	0.05-0.16	0.35-1.9	●		▲	▲		●	●	●					●	
		060208E-PC2	0.8	0.10-0.32	0.70-1.9	●		▲	▲		●	●	●					●	
		09T304E-PC2	0.4	0.05-0.16	0.35-2.9	●	●	▲	▲		●	●	●					●	
		09T308E-PC2	0.8	0.10-0.32	0.70-2.9	●	●	▲	▲		●	●	●					●	
		09T312E-PC2	1.2	0.16-0.48	1.05-2.9		●	▲	▲		●	●	●						
		120404E-PC2	0.4	0.05-0.16	0.35-3.9	●		▲	▲		●	●	●					●	
		120408E-PC2	0.8	0.10-0.32	0.70-3.9	●		▲	▲		●	●	●					●	
		120412E-PC2	1.2	0.16-0.48	1.05-3.9	●		▲	▲		●	●	●					●	
		CPMT 090304E-PC2	0.4	0.05-0.15	0.35-2.9	●													
	090308E-PC2	0.8	0.10-0.32	0.70-2.9	●														

●: Stock available ▲: Stock available now but will be replaced in the future.

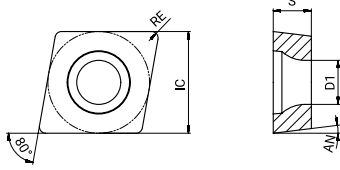
Positive 80° (C)



Dimension (mm)				
Product code	IC	S	D1	AN
CC_0301_	3.5	1.4	2.0	7°
CC_0602_	6.35	2.38	2.8	7°
CC_09T3_	9.525	3.97	4.4	7°
CC_1204_	12.7	4.76	5.5	7°

Inserts Left-hand shown where it's applicable		Product code	RE (mm)	Recommended parameters		Machining conditions															
				f (mm/rev)	ap (mm)	p					M				K			N	S		
						AT202	AC052P	AC150P	AC250P	AC350P	AC100M	AC200M	AP200U	AP301M	AC100K	AC102K	AC202K	AW100K	AP100S		
Semi-Finishing 	CCMT 09T304E-M2T	0.4	0.10-0.25	0.70-3.5	●																
	09T308E-M2T	0.8	0.10-0.25	0.70-3.5	●																
	CCMT 060204E-KC2	0.4	0.06-0.18	0.40-2.1	●		▲	▲	●	●	●	●					●	●		●	
	060208E-KC2	0.8	0.12-0.36	0.80-2.1	●		▲	▲	●	●	●	●					●	●			
	09T304E-KC2	0.4	0.06-0.18	0.40-3.2	●		▲	▲	●	●	●	●					●	●			
	09T308E-KC2	0.8	0.12-0.36	0.80-3.2	●		▲	▲	●	●	●	●			●		●	●			
	120404E-KC2	0.4	0.06-0.18	0.40-4.3	●		▲	▲	●	●	●	●					●	●			
120408E-KC2	0.8	0.12-0.36	0.80-4.3	●		▲	▲	●	●	●	●					●	●				
120412E-KC2	1.2	0.18-0.54	1.20-4.3	●		▲	▲	●	●	●	●					●	●				
Roughing 	CCMW060204E-KD5	0.4	0.10-0.22	0.40-3.2													●	●			
	09T304E-KD5	0.4	0.10-0.22	0.40-4.8													●	●			
	09T308E-KD5	0.8	0.20-0.44	0.80-4.8													●	●			
	120404E-KD5	0.4	0.10-0.22	0.40-6.4													●	●			
	120408E-KD5	0.8	0.20-0.44	0.80-6.4													●	●			
	120412E-KD5	1.2	0.30-0.66	1.20-6.4													●	●			
Finishing 	CCET 0301003FR-F	<0.03	0.01-0.05	0.1-0.3										●							
	0301003FL-F	<0.03	0.01-0.05	0.1-0.3										●							
	0301005FR-F	<0.05	0.01-0.05	0.1-0.3										●							
	0301005FL-F	<0.05	0.01-0.05	0.1-0.3										●							
	030101FR-F	<0.1	0.01-0.05	0.1-0.3										●							
	030101FL-F	<0.1	0.01-0.05	0.1-0.3										●							
	030102FR-F	<0.2	0.01-0.05	0.1-0.3										●							
	030102FL-F	<0.2	0.01-0.05	0.1-0.3										●							
	030104FR-F	<0.4	0.01-0.05	0.1-0.3										●							
	030104FL-F	<0.4	0.01-0.05	0.1-0.3										●							

● : Stock available ▲ : Stock available now but will be replaced in the future.

Positive 80° (C)

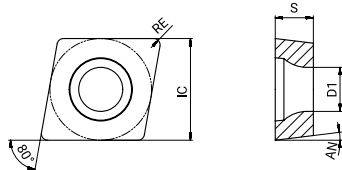

Dimension (mm)				
Product code	IC	S	D1	AN
CC_0401_	4.3	1.8	2.3	7°
CC_0602_	6.35	2.38	2.8	7°
CC_09T3_	9.525	3.97	4.4	7°

Inserts Left-hand shown where it's applicable	Product code	RE (mm)	Recommended parameters		Machining conditions															
			f (mm/rev)	ap (mm)	p					M					K			N	S	
					AT202	AC052P	AC150P	AC250P	AC350P	AC100M	AC200M	AP200U	AP301M	AC100K	AC102K	AC202K	AW100K	AP100S		
Finishing	CCET 0401003FR-F	<0.03	0.01-0.06	0.1-0.4	●	●	●	●	●	●	●	●	●	●	●	●	●	●	●	●
	0401003FL-F	<0.03	0.01-0.06	0.1-0.4																
	0401005FR-F	<0.05	0.01-0.06	0.1-0.4																
	0401005FL-F	<0.05	0.01-0.06	0.1-0.4																
	040101FR-F	<0.1	0.01-0.06	0.1-0.4																
	040101FL-F	<0.1	0.01-0.06	0.1-0.4																
	040102FR-F	<0.2	0.01-0.06	0.1-0.4																
	040102FL-F	<0.2	0.01-0.06	0.1-0.4																
	040104FR-F	<0.4	0.01-0.06	0.1-0.4																
	040104FL-F	<0.4	0.01-0.06	0.1-0.4																
Low feed	CCET 0602003FR-M	<0.03	0.02-0.10	0.5-2.5																
	0602003FL-M	<0.03	0.02-0.10	0.5-2.5																
	0602005FR-M	<0.05	0.02-0.10	0.5-2.5																
	0602005FL-M	<0.05	0.02-0.10	0.5-2.5																
	060201FR-M	<0.1	0.02-0.10	0.5-2.5																
	060201FL-M	<0.1	0.02-0.10	0.5-2.5																
	060202FR-M	<0.2	0.02-0.10	0.5-2.5																
	060202FL-M	<0.2	0.02-0.10	0.5-2.5																
	060204FR-M	<0.4	0.01-0.10	0.5-2.5																
	060204FL-M	<0.4	0.01-0.10	0.5-2.5																
	CCET 09T3003FR-M	<0.03	0.02-0.10	0.5-4.0																
	09T3003FL-M	<0.03	0.02-0.10	0.5-4.0																
	09T3005FR-M	<0.05	0.02-0.10	0.5-4.0																
	09T3005FL-M	<0.05	0.02-0.10	0.5-4.0																
	09T301FR-M	<0.1	0.02-0.10	0.5-4.0																
	09T301FL-M	<0.1	0.02-0.10	0.5-4.0																
	09T302FR-M	<0.2	0.02-0.10	0.5-4.0																
	09T302FL-M	<0.2	0.02-0.10	0.5-4.0																
	09T304FR-M	<0.4	0.02-0.10	0.5-4.0																
	09T304FL-M	<0.4	0.02-0.10	0.5-4.0																

●: Stock available ▲: Stock available now but will be replaced in the future.

Positive 55° (D)

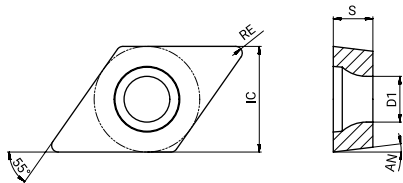

Dimension (mm)				
Product code	IC	S	D1	AN
DC_0702_	6.35	2.38	2.8	7°
DC_11T3_	9.525	3.97	4.4	7°

Inserts	Product code	RE (mm)	Recommended parameters		Machining conditions																					
					● Good condition ● General condition ● Bad condition																					
			f (mm/rev)	ap (mm)	AT202	AC052P	AC150P	AC250P	AC350P	AC100M	AC200M	AP200U	AP301M	AC100K	AC102K	AC202K	AW100K	AP100S								
		p				M				K				N		S										
Finishing	DCGT 0702005FP-LF	<0.05	0.05-0.15	0.35-3.0															●							
	070201FP-LF	<0.1	0.05-0.2	0.35-3.0															●							
	070202FP-LF	0.2	0.05-0.2	0.35-3.0															●							
	070204FP-LF	0.4	0.05-0.2	0.35-3.0															●							
	11T301FP-LF	<0.1	0.05-0.2	0.35-3.0															●							
	11T302FP-LF	0.2	0.05-0.2	0.35-3.0															●							
	11T304FP-LF	0.4	0.05-0.2	0.35-3.0															●							
	DCGT 0702005FP-UF	<0.05	0.02-0.15	0.10-1.4																●						
	070201FP-UF	0.1	0.02-0.15	0.10-1.4																●						
	070202FP-UF	0.2	0.02-0.15	0.10-1.4																●						
	070204FP-UF	0.4	0.03-0.20	0.10-1.4																●						
	11T301FP-UF	0.1	0.02-0.15	0.10-2.4																●						
	11T302FP-UF	0.2	0.02-0.15	0.10-2.4																●						
	11T304FP-UF	0.4	0.03-0.20	0.10-2.4																●						
	DCGT 0702005F-UF	<0.05	0.02-0.15	0.10-1.4																▲						
	070201F-UF	0.1	0.02-0.15	0.10-1.4																▲						
	070202F-UF	0.2	0.02-0.15	0.10-1.4																▲						
	070204F-UF	0.4	0.03-0.20	0.10-1.4																▲						
	11T301F-UF	0.1	0.02-0.15	0.10-2.4																▲						
	11T302F-UF	0.2	0.02-0.15	0.10-2.4																▲						
	11T304F-UF	0.4	0.03-0.20	0.10-2.4																▲						
	DCGT 070201E-UF	0.1	0.02-0.15	0.10-1.4																●						●
	070202E-UF	0.2	0.02-0.15	0.10-1.4																●						●
	070204E-UF	0.4	0.03-0.20	0.10-1.4																●						●
11T301E-UF	0.1	0.02-0.15	0.10-2.4																●						●	
11T302E-UF	0.2	0.02-0.15	0.10-2.4																●						●	
11T304E-UF	0.4	0.03-0.20	0.10-2.4																●						●	

●: Stock available ▲: Stock available now but will be replaced in the future.

Positive 55° (D)

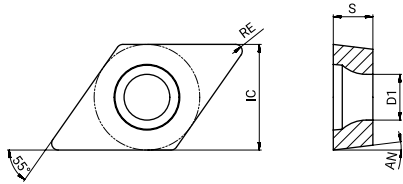

Dimension (mm)				
Product code	IC	S	D1	AN
DC_0702_	6.35	2.38	2.8	7°
DC_11T3_	9.525	3.97	4.4	7°

Inserts	Product code	RE (mm)	Recommended parameters		Machining conditions													
			f (mm/rev)	ap (mm)	● Good condition ● General condition ● Bad condition													
					p						M			K			N	S
					AT202	AC052P	AC150P	AC250P	AC350P	AC100M	AC200M	AP200U	AP301M	AC100K	AC102K	AC202K	AW100K	AP100S
Semi-Finishing	DCGT 070202F-NC2	0.2	0.02-0.10	0.16-3.5														
	070204F-NC2	0.4	0.05-0.20	0.32-3.5														
	11T302F-NC2	0.2	0.02-0.10	0.16-5.2														
	11T304F-NC2	0.4	0.05-0.20	0.32-5.2														
	11T308F-NC2	0.8	0.10-0.40	0.64-5.2														
Finishing	DCMT070202F-F1T	0.2	0.07-0.20	0.40-1.5														
	070204F-F1T	0.4	0.07-0.20	0.40-1.5														
	11T302F-F1T	0.2	0.07-0.20	0.40-1.5														
	11T304F-F1T	0.4	0.10-0.25	0.60-1.5														
	11T308F-F1T	0.8	0.10-0.25	0.60-1.5														
	DCMT070202E-PB1	0.2	0.02-0.07	0.15-1.5														
	070204E-PB1	0.4	0.04-0.14	0.30-1.5														
	11T302E-PB1	0.2	0.02-0.07	0.15-2.3														
	11T304E-PB1	0.4	0.04-0.14	0.30-2.3														
	11T308E-PB1	0.8	0.09-0.28	0.60-2.3														
Semi-Finishing	DCMT070204E-PC2	0.4	0.05-0.16	0.35-2.1														
	070208E-PC2	0.8	0.10-0.32	0.70-2.1														
	11T304E-PC2	0.4	0.05-0.16	0.35-3.1														
	11T308E-PC2	0.8	0.10-0.32	0.70-3.1														
	11T312E-PC2	1.2	0.16-0.48	1.05-3.1														
	DCMT11T304-M2T	0.4	0.10-0.25	0.50-3.0														
	11T308-M2T	0.8	0.10-0.25	0.50-3.0														
Medium	DCMT070204E-KC2	0.4	0.06-0.18	0.40-2.3														
	070208E-KC2	0.8	0.12-0.36	0.80-2.3														
	11T304E-KC2	0.4	0.06-0.18	0.40-3.5														
	11T308E-KC2	0.8	0.12-0.36	0.80-3.5														
	11T312E-KC2	1.2	0.18-0.54	1.20-3.5														

● : Stock available ▲ : Stock available now but will be replaced in the future.

Positive 55° (D)

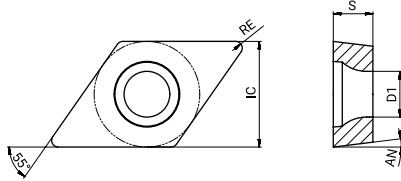

Dimension (mm)				
Product code	IC	S	D1	AN
DC_0702_	6.35	2.38	2.8	7°
DC_11T3_	9.525	3.97	4.4	7°

Inserts Left-hand shown where it's applicable	Product code	RE (mm)	Recommended parameters		Machining conditions																
			f (mm/rev)	ap (mm)	● Good condition ● General condition ● Bad condition																
					●	●	●	●	●	●	●	●	●	●	●	●	●	●	●	●	●
			p		M					K					N		S				
					AT202	AC052P	AC150P	AC250P	AC350P	AC100M	AC200M	AP200U	AP301M	AC100K	AC102K	AC202K	AW100K	AP100S			
Roughing	DCMW 070204E-KD5	0.4	0.06-0.18	0.40-3.9											●	●					
	070208E-KD5	0.8	0.12-0.36	0.80-3.9											●	●					
	11T304E-KD5	0.4	0.06-0.18	0.40-5.8											●	●					
	11T308E-KD5	0.8	0.12-0.36	0.80-5.8											●	●					
Finishing	DCET 0702003FR-F	<0.03	0.02-0.18	0.1-0.4									●								
	0702003FL-F	<0.03	0.02-0.18	0.1-0.4									●								
	0702005FR-F	<0.05	0.02-0.18	0.1-0.4									●								
	0702005FL-F	<0.05	0.02-0.18	0.1-0.4									●								
	070201FR-F	<0.1	0.02-0.18	0.1-0.4									●								
	070201FL-F	<0.1	0.02-0.18	0.1-0.4									●								
	070202FR-F	<0.2	0.02-0.18	0.1-0.4									●								
	070202FL-F	<0.2	0.02-0.18	0.1-0.4									●								
	070204FR-F	<0.4	0.02-0.18	0.1-0.4									●								
	070204FL-F	<0.4	0.02-0.18	0.1-0.4									●								
	DCET 11T3003FR-F	<0.03	0.02-0.20	0.1-0.4									●								
	11T3003FL-F	<0.03	0.02-0.20	0.1-0.4									●								
	11T3005FR-F	<0.05	0.02-0.20	0.1-0.4									●								
	11T3005FL-F	<0.05	0.02-0.20	0.1-0.4									●								
	11T301FR-F	<0.1	0.02-0.20	0.1-0.4									●								
	11T301FL-F	<0.1	0.02-0.20	0.1-0.4									●								
	11T302FR-F	<0.2	0.02-0.20	0.1-0.4									●								
	11T302FL-F	<0.2	0.02-0.20	0.1-0.4									●								
	11T304FR-F	<0.4	0.02-0.20	0.1-0.4									●								
	11T304FL-F	<0.4	0.02-0.20	0.1-0.4									●								

●: Stock available ▲: Stock available now but will be replaced in the future.

Positive 55° (D)

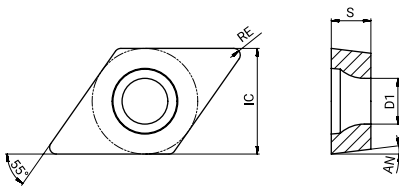

Product code	Dimension (mm)			AN
	IC	S	D1	
DC_0702_	6.35	2.38	2.8	7°
DC_11T3_	9.525	3.97	4.4	7°

Inserts Left-hand shown where it's applicable		Product code	RE (mm)	Recommended parameters		Machining conditions															
				f (mm/rev)	ap (mm)	p				M				K			N	S			
						● Good condition ⬠ General condition ✘ Bad condition ● ● ● ⬠ ✘ ● ⬠ ✘ ✘ ● ● ✘ ⬠ ●															
						AT202	AC052P	AC150P	AC250P	AC350P	AC100M	AC200M	AP200U	AP301M	AC100K	AC102K	AC202K	AW100K	AP100S		
Low feed		DCET 0702003FR-M	<0.03	0.01-0.08	0.5-2.8									●							
		0702003FL-M	<0.03	0.01-0.08	0.5-2.8									●							
		0702005FR-M	<0.05	0.01-0.08	0.5-2.8									●							
		0702005FL-M	<0.05	0.01-0.08	0.5-2.8									●							
		070201FR-M	<0.1	0.01-0.08	0.5-2.8									●							
		070201FL-M	<0.1	0.01-0.08	0.5-2.8									●							
		070202FR-M	<0.2	0.01-0.08	0.5-2.8									●							
		070202FL-M	<0.2	0.01-0.08	0.5-2.8									●							
		070204FR-M	<0.4	0.01-0.08	0.5-2.8									●							
		070204FL-M	<0.4	0.01-0.08	0.5-2.8									●							
		DCET 11T3003FR-M	<0.03	0.01-0.10	0.5-4.0									●							
		11T3003FL-M	<0.03	0.01-0.10	0.5-4.0									●							
		11T3005FR-M	<0.05	0.01-0.10	0.5-4.0									●							
		11T3005FL-M	<0.05	0.01-0.10	0.5-4.0									●							
		11T301FR-M	<0.1	0.01-0.10	0.5-4.0									●							
		11T301FL-M	<0.1	0.01-0.10	0.5-4.0									●							
		11T302FR-M	<0.2	0.01-0.10	0.5-4.0									●							
		11T302FL-M	<0.2	0.01-0.10	0.5-4.0									●							
		11T304FR-M	<0.4	0.01-0.10	0.5-4.0									●							
		11T304FL-M	<0.4	0.01-0.10	0.5-4.0									●							

ISO Turning Insert

●: Stock available ▲: Stock available now but will be replaced in the future.

Positive 90° (S)

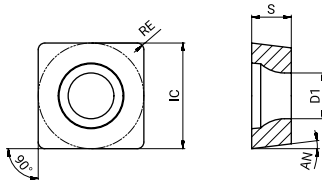

Product code	Dimension (mm)			
	IC	S	D1	AN
SC_09T3_	9.525	3.97	4.4	7°
SC_1204_	12.7	4.76	5.5	7°
SC_3809_	38.1	9.525	9.8	7°

Inserts	Product code	RE (mm)	Recommended parameters		Machining conditions													
					● Good condition ● General condition ❖ Bad condition													
					●	●	●	●	❖	●	●	●	●	●	❖	●		
					p			M			K			N	S			
					AT202	AC052P	AC150P	AC250P	AC350P	AC100M	AC200M	AP200U	AP301M	AC100K	AC102K	AC202K	AW100K	AP100S
Semi-Finishing	SCGT 09T308F-NC2	0.8	0.10-0.40	0.64-4.3													●	
Finishing	SCMT 09T304E-PB1	0.4	0.04-0.14	0.30-2.4	●		▲	▲		●	●	●						
	09T308E-PB1	0.8	0.09-0.28	0.60-2.4	●		▲	▲		●	●	●						
	120404E-PB1	0.4	0.04-0.14	0.30-3.2			▲	▲		●	●	●						
Semi-Finishing	SCMT 09T304E-PC2	0.4	0.05-0.16	0.35-2.9	●		▲	▲		●	●	●						●
	09T308E-PC2	0.8	0.10-0.32	0.70-2.9	●		▲	▲		●	●	●						●
	120404E-PC2	0.4	0.05-0.16	0.35-3.8	●		▲	▲		●	●	●						●
	120408E-PC2	0.8	0.10-0.32	0.70-3.8	●	●	▲	▲		●	●	●						●
	120412E-PC2	1.2	0.16-0.48	1.05-3.8		●	▲	▲		●	●	●						●
	SCMT 09T304-M2T	0.4	0.10-0.25	0.70-3.5	●													
	09T308-M2T	0.8	0.10-0.25	0.70-3.5	●													
Medium	SCMT 09T304E-KC2	0.4	0.06-0.18	0.40-3.1	●		▲	▲	●						●	●		
	09T308E-KC2	0.8	0.12-0.36	0.80-3.1	●		▲	▲	●						●	●		
	120404E-KC2	0.4	0.06-0.18	0.40-4.2	●		▲	▲	●						●	●		
	120408E-KC2	0.8	0.12-0.36	0.80-4.2	●		▲	▲	●						●	●		
	120412E-KC2	1.2	0.18-0.54	1.20-4.2			▲	▲	●						●	●		
	SCMW 09T304E-KD5	0.4	0.10-0.22	0.40-4.8											●	●		
	09T308E-KD5	0.8	0.20-0.44	0.80-4.8										●	●	●		
	120404E-KD5	0.4	0.10-0.22	0.40-6.4											●	●		
	120408E-KD5	0.8	0.20-0.44	0.80-6.4											●	●		
	120412E-KD5	1.2	0.30-0.66	1.20-6.4										●	●	●		
Roughing	SCMT 380932S-HT	3.2	0.70-1.40	4.0-18.0					●									

● : Stock available ▲ : Stock available now but will be replaced in the future.

Positive 60° (T)

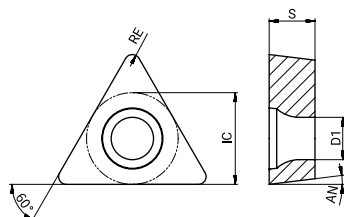

Dimension (mm)				
Product code	IC	S	D1	AN
TC_1102_	6.35	2.38	2.8	7°
TC_16T3_	9.525	3.97	4.4	7°

Inserts	Product code	RE (mm)	Recommended parameters		Machining conditions																							
			f (mm/rev)	ap (mm)	p				M				K				N		S									
					AT202	AC052P	AC150P	AC250P	AC350P	AC100M	AC200M	AP200U	AP301M	AC100K	AC102K	AC202K	AW100K	AP100S										
Finishing		TCGT 110201FP-LF	<0.1	0.05-0.2	0.35-3.0													●										
		110202FP-LF	0.2	0.05-0.2	0.35-3.0														●									
		110204FP-LF	0.4	0.05-0.2	0.35-3.0															●								
		16T304FP-LF	0.4	0.05-0.2	0.35-3.0															●								
		TCGT 110201FP-UF	<0.1	0.02-0.15	0.10-2.4														●									
		110202FP-UF	0.2	0.02-0.15	0.20-2.4														●									
		110204FP-UF	0.4	0.03-0.20	0.20-2.4														●									
		16T304FP-UF	0.4	0.03-0.20	0.20-2.4														●									
		TCGT 110201F-UF	0.1	0.02-0.15	0.10-2.4														▲									
		110202F-UF	0.2	0.02-0.15	0.20-2.4														▲									
		110204F-UF	0.4	0.03-0.20	0.20-2.4														▲									
		16T304F-UF	0.4	0.03-0.20	0.20-2.4														▲									
		TCGT 110201E-UF	0.1	0.02-0.15	0.10-2.4														●							●		
		110202E-UF	0.2	0.02-0.15	0.20-2.4														●							●		
		110204E-UF	0.4	0.03-0.20	0.20-2.4														●							●		
		16T304E-UF	0.4	0.03-0.20	0.20-2.4														●							●		
Semi-Finishing		TCGT 110204F-NC2	0.4	0.05-0.20	0.32-4.9																			●				
		16T304F-NC2	0.4	0.05-0.20	0.32-7.4																				●			
		16T308F-NC2	0.8	0.10-0.40	0.64-7.4																				●			

●: Stock available ▲: Stock available now but will be replaced in the future.

ISO Turning Insert

Positive 60° (T)

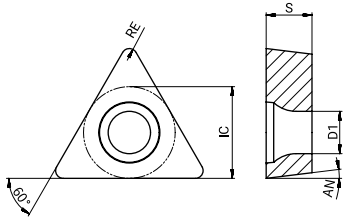

Dimension (mm)				
Product code	IC	S	D1	AN
TCMT_0902_	5.56	2.38	2.5	7°
TC_1102_	6.35	2.38	2.8	7°
TC_16T3_	9.525	3.97	4.4	7°

Dimension (mm)				
Product code	IC	S	D1	AN
TPMT_0902_	5.56	2.38	2.5	11°
TPMT_1103_	6.35	3.18	3.4	11°
TPMT_1603_	9.525	3.18	4.4	11°



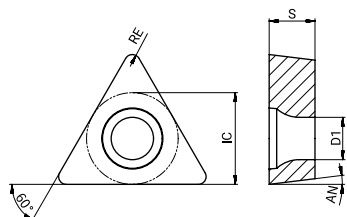

Inserts	Product code	RE (mm)	Recommended parameters		Machining conditions																						
			f (mm/rev)	ap (mm)	p					M				K			N	S									
					AT202	AC052P	AC150P	AC250P	AC350P	AC100M	AC200M	AP200U	AP301M	AC100K	AC102K	AC202K	AW100K	AP100S									
Finishing	TCMT 090204E-PB1	0.4	0.04-0.14	0.30-1.9	●		▲	▲			●	●	●														
	110202E-PB1	0.2	0.02-0.07	0.15-2.2	●		▲	▲			●	●	●														
	110204E-PB1	0.4	0.04-0.14	0.30-2.2	●		▲	▲			●	●	●														
	110208E-PB1	0.8	0.09-0.28	0.60-2.2	●		▲	▲			●	●	●														
	16T304E-PB1	0.4	0.04-0.14	0.30-3.3	●		▲	▲			●	●	●														
	16T308E-PB1	0.8	0.09-0.28	0.60-3.3	●		▲	▲			●	●	●														
	TPMT 090202E-PB1	0.2	0.02-0.07	0.15-1.9	●																						
	090204E-PB1	0.4	0.04-0.14	0.30-1.9	●																						
	090208E-PB1	0.8	0.09-0.28	0.60-1.9	●																						
	110302E-PB1	0.2	0.02-0.07	0.15-2.2	●																						
	110304E-PB1	0.4	0.04-0.14	0.30-2.2	●																						
	110308E-PB1	0.8	0.09-0.28	0.60-2.2	●																						
	160304E-PB1	0.4	0.04-0.14	0.30-3.3	●																						
	160308E-PB1	0.8	0.09-0.28	0.60-3.3	●																						
Semi-Finishing	TCMT 090204E-PC2	0.4	0.05-0.16	0.35-2.6	●		▲	▲			●	●	●												●		
	090208E-PC2	0.8	0.10-0.32	0.70-2.6	●		▲	▲			●	●	●												●		
	110204E-PC2	0.4	0.05-0.16	0.35-3.0	●		▲	▲			●	●	●												●		
	110208E-PC2	0.8	0.10-0.32	0.70-3.0	●		▲	▲			●	●	●												●		
	16T304E-PC2	0.4	0.05-0.16	0.35-4.5	●		▲	▲			●	●	●												●		
	16T308E-PC2	0.8	0.10-0.32	0.70-4.5	●	●	▲	▲			●	●	●												●		
	16T312E-PC2	1.2	0.16-0.48	1.05-4.5			▲	▲			●	●	●												●		
	TPMT 090204E-PC2	0.4	0.05-0.16	0.35-2.6	●		▲	▲			●	●	●														
	090208E-PC2	0.8	0.10-0.32	0.70-2.6	●		▲	▲			●	●	●														
	110304E-PC2	0.4	0.05-0.16	0.35-3.0	●		▲	▲			●	●	●												●		
	110308E-PC2	0.8	0.10-0.32	0.70-3.0	●		▲	▲			●	●	●														
	160304E-PC2	0.4	0.10-0.25	0.60-2.0	●						●	●	●														
	160308E-PC2	0.8	0.10-0.25	0.60-2.0	●						●	●	●														

●: Stock available ▲: Stock available now but will be replaced in the future.

Positive 60° (T)



Dimension (mm)				
Product code	IC	S	D1	AN
TBET_0601_	3.97	1.59	2.3	5°
TCMT_0902_	5.56	2.38	2.5	7°
TC_1102_	6.35	2.38	2.8	7°
TC_16T3_	9.525	3.97	4.4	7°

Inserts Left-hand shown where it's applicable	Product code	RE (mm)	Recommended parameters		Machining conditions																								
			f (mm/rev)	ap (mm)	p					M				K			N	S											
			AT202	AC052P	AC150P	AC250P	AC350P	AC100M	AC200M	AP200U	AP301M	AC100K	AC102K	AC202K	AW100K	AP100S													
Semi-Finishing 	TCMT 110204-M2T	0.4	0.10-0.25	0.60-2.0	●																								
	110208-M2T	0.8	0.10-0.25	0.60-2.0	●																								
	16T304-M2T	0.4	0.06-0.18	0.40-2.9	●																								
	16T308-M2T	0.8	0.12-0.36	0.80-2.9	●																								
Medium 	TCMT 090204E-KC2	0.4	0.06-0.18	0.40-2.9	●	●	▲	▲			●	●	●						●	●									
	090208E-KC2	0.8	0.12-0.36	0.80-2.9	●	●	▲	▲			●	●	●						●	●									
	110204E-KC2	0.4	0.06-0.18	0.40-3.3	●	●	▲	▲			●	●	●						●	●									
	110208E-KC2	0.8	0.12-0.36	0.80-3.3	●	●	▲	▲			●	●	●						●	●									
	16T304E-KC2	0.4	0.06-0.18	0.40-4.9	●	●	▲	▲			●	●	●						●	●									
	16T308E-KC2	0.8	0.12-0.36	0.80-4.9	●	●	▲	▲			●	●	●						●	●									
Roughing 	TCMW 110204E-KD5	0.4	0.06-0.18	0.40-5.5															●	●									
	110208E-KD5	0.8	0.12-0.36	0.80-5.5															●	●									
	16T304E-KD5	0.4	0.06-0.18	0.40-8.2															●	●									
	16T308E-KD5	0.8	0.12-0.36	0.80-8.2															●	●									
Finishing 	TBET 0601003FR-F	<0.03	0.03-0.08	0.1-0.5															●										
	0601003FL-F	<0.03	0.03-0.08	0.1-0.5															●										
	0601005FR-F	<0.05	0.03-0.08	0.1-0.5															●										
	0601005FL-F	<0.05	0.03-0.08	0.1-0.5															●										
	060101FR-F	<0.1	0.03-0.08	0.1-0.5															●										
	060101FL-F	<0.1	0.03-0.08	0.1-0.5															●										
	060102FR-F	<0.2	0.03-0.08	0.1-0.5															●										
	060102FL-F	<0.2	0.03-0.08	0.1-0.5															●										
	060104FR-F	<0.4	0.03-0.08	0.1-0.5															●										
	060104FL-F	<0.4	0.03-0.08	0.1-0.5															●										

●: Stock available ▲: Stock available now but will be replaced in the future.

ISO Turning Insert

Positive 60° (T)

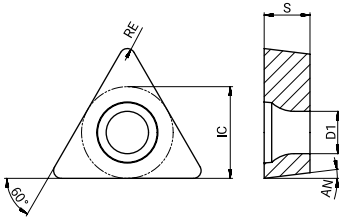

Dimension (mm)				
Product code	IC	S	D1	AN
TPEH_0802_	4.76	2.38	2.3	11°
TPEH_0902_	5.56	2.38	3.0	11°
TCET_1102_	6.35	2.41	2.8	11°

Inserts Left-hand shown where it's applicable	Product code	RE (mm)	Recommended parameters		Machining conditions																							
			f (mm/rev)	ap (mm)	p						M				K			N		S								
					AT202	AC052P	AC150P	AC250P	AC350P	AC100M	AC200M	AP200U	AP301M	AC100K	AC102K	AC202K	AW100K	AP100S										
Finishing		TCET 110201FR-F	<0.1	0.03-0.13	0.10-0.80	●	●	●	●	●	●	●	●	●	●	●	●	●	●	●	●	●	●	●	●	●		
	110201FL-F	<0.1	0.03-0.13	0.10-0.80																								
	110202FR-F	<0.2	0.03-0.13	0.10-0.80																								
	110202FL-F	<0.2	0.03-0.13	0.10-0.80																								
	110204FR-F	<0.4	0.03-0.13	0.10-0.80																								
	110204FL-F	<0.4	0.03-0.13	0.10-0.80																								
	110208FR-F	<0.8	0.03-0.13	0.10-0.80																								
	110208FL-F	<0.8	0.03-0.13	0.10-0.80																								
		TPEH 080201FR-F	<0.1	0.01-0.10	0.1-0.8																							
	080201FL-F	<0.1	0.01-0.10	0.1-0.8																								
	080202FR-F	<0.2	0.01-0.10	0.1-0.8																								
	080202FL-F	<0.2	0.01-0.10	0.1-0.8																								
	080204FR-F	<0.4	0.01-0.10	0.1-0.8																								
	080204FL-F	<0.4	0.01-0.10	0.1-0.8																								
		TPEH 090201FR-F	<0.1	0.01-0.10	0.1-0.8																							
	090201FL-F	<0.1	0.01-0.10	0.1-0.8																								
	090202FR-F	<0.2	0.01-0.10	0.1-0.8																								
	090202FL-F	<0.2	0.01-0.10	0.1-0.8																								
	090204FR-F	<0.4	0.01-0.10	0.1-0.8																								
	090204FL-F	<0.4	0.01-0.10	0.1-0.8																								

●: Stock available ▲: Stock available now but will be replaced in the future.

Positive 60° (T)

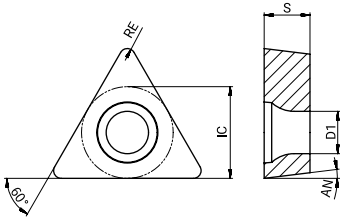

Dimension (mm)				
Product code	IC	S	D1	AN
TCET_0802_	4.76	2.38	2.3	7°
TCET_1103_	6.35	3.18	2.8	7°
TPEH_1103_	6.35	3.18	3.3	11°





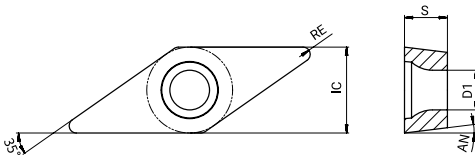

Inserts Left-hand shown where it's applicable	Product code	RE (mm)	Recommended parameters		Machining conditions															
			f (mm/rev)	ap (mm)	● Good condition ● General condition ● Bad condition															
					P						M				K			N		S
					AT202	AC052P	AC150P	AC250P	AC350P	AC100M	AC200M	AP200U	AP301M	AC100K	AC102K	AC202K	AW100K	AP100S		
Finishing	TPEH 110302FR-F	<0.2	0.01-0.12	0.2-0.8									●							
	110302FL-F	<0.2	0.01-0.12	0.2-0.8									●							
	110304FR-F	<0.4	0.01-0.12	0.2-0.8									●							
	110304FL-F	<0.4	0.01-0.12	0.2-0.8									●							
	110308FR-F	<0.8	0.01-0.12	0.2-0.8									●							
	110308FL-F	<0.8	0.01-0.12	0.2-0.8									●							
Low feed	TCET 0802003FR-M	<0.03	0.01-0.08	0.5-2.5									●							
	0802003FL-M	<0.03	0.01-0.08	0.5-2.5									●							
	080201FR-M	<0.1	0.01-0.08	0.5-2.5									●							
	080201FL-M	<0.1	0.01-0.08	0.5-2.5									●							
	080202FR-M	<0.2	0.01-0.08	0.5-2.5									●							
	080202FL-M	<0.2	0.01-0.08	0.5-2.5									●							
	TCET 1103003FR-M	<0.03	0.02-0.10	0.5-4.0										●						
	1103003FL-M	<0.03	0.02-0.10	0.5-4.0										●						
	110301FR-M	<0.1	0.02-0.10	0.5-4.0										●						
	110301FL-M	<0.1	0.02-0.10	0.5-4.0										●						
	110302FR-M	<0.2	0.02-0.10	0.5-4.0										●						
	110302FL-M	<0.2	0.02-0.10	0.5-4.0										●						
	110304FR-M	<0.4	0.02-0.10	0.5-4.0										●						
	110304FL-M	<0.4	0.02-0.10	0.5-4.0										●						

●: Stock available ▲: Stock available now but will be replaced in the future.

Positive 35° (V)



Dimension (mm)				
Product code	IC	S	D1	AN
VB_1103_	6.35	3.18	2.8	5°
VB_1604_	9.52	4.76	4.4	5°
VC_1103_	6.35	3.18	2.8	7°
VP_1103_	6.35	3.18	2.8	11°

Inserts	Product code	RE (mm)	Recommended parameters		Machining conditions																						
			f (mm/rev)	ap (mm)	p				M				K				N		S								
					AT202	AC052P	AC150P	AC250P	AC350P	AC100M	AC200M	AP200U	AP301M	AC100K	AC102K	AC202K	AW100K	AP100S									
Finishing	 VBGT 1103005FP-LF	<0.05	0.05-0.2	0.35-3.0																							
	110301FP-LF	<0.1	0.05-0.2	0.35-3.0																							
	110302FP-LF	0.2	0.05-0.2	0.35-3.0																							
	110304FP-LF	0.4	0.05-0.2	0.35-3.0																							
	160401FP-LF	<0.1	0.05-0.2	0.35-3.0																							
	160402FP-LF	0.2	0.05-0.2	0.35-3.0																							
	 VCGT 1103005FP-LF	<0.05	0.05-0.2	0.35-3.0																							
	110301FP-LF	<0.1	0.05-0.2	0.35-3.0																							
	110302FP-LF	0.2	0.05-0.2	0.35-3.0																							
	110304FP-LF	0.4	0.05-0.2	0.35-3.0																							
	 VPGT 1103005FP-LF	<0.05	0.05-0.2	0.35-3.0																							
	110301FP-LF	<0.1	0.05-0.2	0.35-3.0																							
	110302FP-LF	0.2	0.05-0.2	0.35-3.0																							
	 VBGT 110301FP-UF	0.1	0.02-0.15	0.10-1.4																							
	110302FP-UF	0.2	0.02-0.15	0.20-1.4																							
	110304FP-UF	0.4	0.03-0.20	0.20-1.4																							
	160401FP-UF	0.1	0.02-0.15	0.10-1.4																							
	160402FP-UF	0.2	0.02-0.15	0.20-1.4																							
	 VBGT 110301F-UF	0.1	0.02-0.15	0.10-1.4																							
	110302F-UF	0.2	0.02-0.15	0.20-1.4																							
	110304F-UF	0.4	0.03-0.20	0.20-1.4																							
	160401F-UF	0.1	0.02-0.15	0.10-1.4																							
	160402F-UF	0.2	0.02-0.15	0.20-1.4																							
	 VBGT 110301E-UF	0.1	0.02-0.15	0.10-1.4																							●
	110302E-UF	0.2	0.02-0.15	0.20-1.4																							●
	110304E-UF	0.4	0.03-0.20	0.20-1.4																							●
	160401E-UF	0.1	0.02-0.15	0.10-1.4																							●
	160402E-UF	0.2	0.02-0.15	0.20-1.4																							●

●: Stock available ▲: Stock available now but will be replaced in the future.

Positive 35° (V)

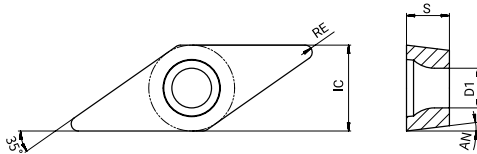

Dimension (mm)				
Product code	IC	S	D1	AN
VB_1103_	6.35	3.18	2.8	5°
VB_1604_	9.52	4.76	4.4	5°
VC_1103_	6.35	3.18	2.8	7°
VC_1604_	9.525	4.76	4.4	7°
VC_2205_	12.7	5.56	5.5	7°
VP_1103_	6.35	3.18	2.8	11°
VP_2205_	12.7	5.56	5.5	11°

Inserts	Product code	RE (mm)	Recommended parameters		Machining conditions																										
			f (mm/rev)	ap (mm)	p					M				K			N	S													
					AT202	AC052P	AC150P	AC250P	AC350P	AC100M	AC200M	AP200U	AP301M	AC100K	AC102K	AC202K	AW100K	AP100S													
Finishing		VCVT 1103005FP-UF	<0.05	0.02-0.15	0.10-1.4																										
		110301FP-UF	0.1	0.02-0.15	0.10-1.4																										
		110302FP-UF	0.2	0.02-0.15	0.20-1.4																										
		110304FP-UF	0.4	0.03-0.20	0.20-1.4																										
		VCVT 1103005F-UF	<0.05	0.02-0.15	0.10-1.4																										
		110301F-UF	0.1	0.02-0.15	0.10-1.4																										
		110302F-UF	0.2	0.02-0.15	0.20-1.4																										
		110304F-UF	0.4	0.03-0.20	0.20-1.4																										
		VCVT 110301E-UF	0.1	0.02-0.15	0.10-1.4																										
		110302E-UF	0.2	0.02-0.15	0.20-1.4																										
		110304E-UF	0.4	0.03-0.20	0.20-1.4																										
			VPGT 110301FP-UF	0.1	0.02-0.15	0.1-1.4																									
			110302FP-UF	0.2	0.02-0.15	0.2-1.4																									
			VPGT 110301F-UF	0.1	0.02-0.15	0.1-1.4																									
110302F-UF	0.2		0.02-0.15	0.2-1.4																											
Semi-Finishing		VCVT 110302F-NC2	0.2	0.02-0.10	0.16-2.8																										
		110304F-NC2	0.4	0.05-0.20	0.32-2.8																										
		160404F-NC2	0.4	0.05-0.20	0.32-4.2																										
		160408F-NC2	0.8	0.10-0.40	0.64-4.2																										
		160412F-NC2	1.2	0.14-0.60	0.96-4.2																										
		220530F-NC2	3.0	0.36-1.50	2.40-5.5																										
		VPGT 220520E-NC2	2.0	0.24-1.0	1.60-5.5																										
		VPGT 220520F-NC2	2.0	0.24-1.0	1.60-5.5																										
Profiling machining		VBMT 110302E-BS	0.2	0.10-0.32	0.70-2.1	●	●																								
		110304E-BS	0.4	0.05-0.16	0.35-3.1	●	●																								
		110308E-BS	0.8	0.10-0.32	0.70-3.1	●	●																								
		160404E-BS	0.4	0.06-0.18	0.40-3.3	●	●																								
		160408E-BS	0.8	0.12-0.36	0.80-3.3	●	●																								
		160412E-BS	1.2	0.18-0.54	1.20-3.3	●	●																								

●: Stock available ▲: Stock available now but will be replaced in the future.

Positive 35° (V)

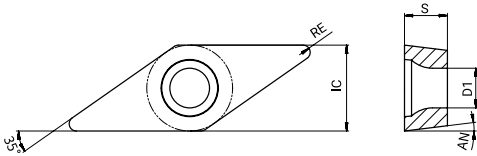

Dimension (mm)				
Product code	IC	S	D1	AN
VB_1103_	6.35	3.18	2.8	5°
VB_1604_	9.52	4.76	4.4	5°
VC_1103_	6.35	3.18	2.8	7°
VC_1604_	9.525	4.76	4.4	7°

Inserts Left-hand shown where it's applicable	Product code	RE (mm)	Recommended parameters		Machining conditions																				
			f (mm/rev)	ap (mm)	p					M				K			N	S							
					AT202	AC052P	AC150P	AC250P	AC350P	AC100M	AC200M	AP200U	AP301M	AC100K	AC102K	AC202K	AW100K	AP100S							
Finishing	VBMT 110304E-PB1	0.4	0.04-0.14	0.30-1.4	●		▲	▲		●	●	●													
	110308E-PB1	0.8	0.09-0.28	0.60-1.4	●		▲	▲		●	●	●													
	160402E-PB1	0.2	0.02-0.07	0.15-2.1	●		▲	▲		●	●	●													
	160404E-PB1	0.4	0.04-0.14	0.30-2.1	●		▲	▲		●	●	●													
	160408E-PB1	0.8	0.09-0.28	0.60-2.1	●		▲	▲		●	●	●													
	VCMT 160404E-PB1	0.4	0.04-0.14	0.30-2.1			▲	▲		●	●	●													
	160408E-PB1	0.8	0.09-0.28	0.60-2.1			▲	▲		●	●	●													
Semi-Finishing	VBMT 110304E-PC2	0.4	0.05-0.16	0.35-2.1	●		▲	▲		●	●	●												●	
	110308E-PC2	0.8	0.10-0.32	0.70-2.1	●		▲	▲		●	●	●												●	
	160404E-PC2	0.4	0.05-0.16	0.35-3.1	●	●	▲	▲		●	●	●												●	
	160408E-PC2	0.8	0.10-0.32	0.70-3.1	●	●	▲	▲		●	●	●												●	
	160412E-PC2	1.2	0.16-0.48	1.05-3.1		●	▲	▲		●	●	●												●	
	VCMT 110304E-PC2	0.4	0.05-0.16	0.35-2.1			▲	▲		●	●	●													
	110308E-PC2	0.8	0.10-0.32	0.70-2.1			▲	▲		●	●	●													
	160404E-PC2	0.4	0.05-0.16	0.35-3.1			▲	▲		●	●	●													
160408E-PC2	0.8	0.10-0.32	0.70-3.1			▲	▲		●	●	●														
Medium	VBMT 160404E-KC2	0.4	0.06-0.18	0.40-3.3	●		▲	▲		●	●	●						●	●						
	160408E-KC2	0.8	0.12-0.36	0.80-3.3	●	●	▲	▲		●	●	●						●	●						
	160412E-KC2	1.2	0.18-0.54	1.20-3.3	●	●	▲	▲		●	●	●						●	●						
Finishing	VBET 1103003FR-F	<0.03	0.01-0.18	0.1-0.3														●							
	1103003FL-F	<0.03	0.01-0.18	0.1-0.3														●							
	1103005FR-F	<0.05	0.01-0.18	0.1-0.3														●							
	1103005FL-F	<0.05	0.01-0.18	0.1-0.3														●							
	110301FR-F	<0.1	0.01-0.18	0.1-0.3														●							
	110301FL-F	<0.1	0.01-0.18	0.1-0.3														●							
	110302FR-F	<0.2	0.01-0.18	0.1-0.3														●							
	110302FL-F	<0.2	0.01-0.18	0.1-0.3														●							

●: Stock available ▲: Stock available now but will be replaced in the future.

Positive 35° (V)

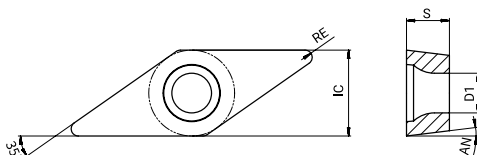

Dimension (mm)				
Product code	IC	S	D1	AN
VB_1103_	6.35	3.18	2.8	5°
VC_1103_	6.35	3.18	2.8	7°
VP_0802_	4.76	2.38	2.3	11°

Inserts Left-hand shown where it's applicable	Product code	RE (mm)	Recommended parameters		Machining conditions															
					● Good condition ● General condition ✖ Bad condition															
			f (mm/rev)	ap (mm)	p				M				K			N	S			
		AT202	AC052P	AC150P	AC250P	AC350P	AC100M	AC200M	AP200U	AP301M	AC100K	AC102K	AC202K	AW100K	AP100S					
Low feed	VBET 1103005FR-M	<0.05	0.01-0.06	0.2-2.0												●				
	1103005FL-M	<0.05	0.01-0.06	0.2-2.0												●				
	110301FR-M	<0.1	0.01-0.06	0.2-2.0												●				
	110301FL-M	<0.1	0.01-0.06	0.2-2.0												●				
	110302FR-M	<0.2	0.01-0.06	0.2-2.0												●				
	110302FL-M	<0.2	0.01-0.06	0.2-2.0												●				
	110304FR-M	<0.4	0.01-0.06	0.2-2.0												●				
	110304FL-M	<0.4	0.01-0.06	0.2-2.0												●				
Finishing	VCET 1103005FR-F	<0.05	0.01-0.18	0.1-0.3												●				
	1103005FL-F	<0.05	0.01-0.18	0.1-0.3												●				
	110301FR-F	<0.1	0.01-0.18	0.1-0.3												●				
	110301FL-F	<0.1	0.01-0.18	0.1-0.3												●				
	110302FR-F	<0.2	0.01-0.18	0.1-0.3												●				
	110302FL-F	<0.2	0.01-0.18	0.1-0.3												●				
	110304FR-F	<0.4	0.01-0.18	0.1-0.3												●				
	110304FL-F	<0.4	0.01-0.18	0.1-0.3												●				
	VPET 080201FR-F	<0.1	0.02-0.15	0.05-0.2													●			
	080201FL-F	<0.1	0.02-0.15	0.05-0.2													●			
	080202FR-F	<0.2	0.02-0.15	0.05-0.2													●			
	080202FL-F	<0.2	0.02-0.15	0.05-0.2													●			

●: Stock available ▲: Stock available now but will be replaced in the future.

Positive 35° (V)

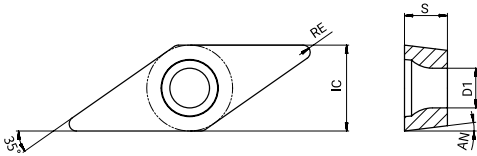

Dimension (mm)				
Product code	IC	S	D1	AN
VB_1103_	6.35	3.18	2.8	5°
VB_1604_	9.52	4.76	4.4	5°
VP_0802_	4.76	2.38	2.3	11°
VP_1103_	6.35	3.18	2.8	11°

Inserts Left-hand shown where it's applicable	Product code	RE (mm)	Recommended parameters		Machining conditions															
			f (mm/rev)	ap (mm)	p					M			K			N	S			
					AT202	AC052P	AC150P	AC250P	AC350P	AC100M	AC200M	AP200U	AP301M	AC100K	AC102K	AC202K	AW100K	AP100S		
Low feed	VPET 080201FR-M	<0.1	0.01-0.06	0.2-1.5											●					
	080201FL-M	<0.1	0.01-0.06	0.2-1.5											●					
	080202FR-M	<0.2	0.01-0.06	0.2-1.5											●					
	080202FL-M	<0.2	0.01-0.06	0.2-1.5											●					
	VPET 110301FR-M	<0.1	0.01-0.06	0.2-2.0											●					
	110301FL-M	<0.1	0.01-0.06	0.2-2.0											●					
	110302FR-M	<0.2	0.01-0.06	0.2-2.0											●					
	110302FL-M	<0.2	0.01-0.06	0.2-2.0											●					
	110304FR-M	<0.4	0.01-0.06	0.2-2.0											●					
	110304FL-M	<0.4	0.01-0.06	0.2-2.0											●					
	VBET 1103003FR-Y	<0.03	0.08-0.22	0.5-1.8											●					
	1103003FL-Y	<0.03	0.08-0.22	0.5-1.8											●					
	1103005FR-Y	<0.05	0.08-0.22	0.5-1.8											●					
	1103005FL-Y	<0.05	0.08-0.22	0.5-1.8											●					
	110301FR-Y	<0.1	0.08-0.22	0.5-1.8											●					
	110301FL-Y	<0.1	0.08-0.22	0.5-1.8											●					
	110302FR-Y	<0.2	0.08-0.22	0.5-1.8											●					
	110302FL-Y	<0.2	0.08-0.22	0.5-1.8											●					
110304FR-Y	<0.4	0.08-0.22	0.5-1.8											●						
110304FL-Y	<0.4	0.08-0.22	0.5-1.8											●						
VBET 160402FR-Y	<0.2	0.1-0.25	0.8-2.0											●						
160402FL-Y	<0.2	0.1-0.25	0.8-2.0											●						
160404FR-Y	<0.4	0.1-0.25	0.8-2.0											●						
160404FL-Y	<0.4	0.1-0.25	0.8-2.0											●						
160408FR-Y	0.8	0.1-0.25	0.8-2.0											●						
160408FL-Y	0.8	0.1-0.25	0.8-2.0											●						

●: Stock available ▲: Stock available now but will be replaced in the future.

Positive 80° (W)

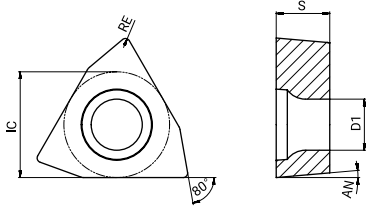

Dimension (mm)				
Product code	IC	S	D1	AN
WB_0601_	3.97	1.59	2.3	5°
WB_0802_	4.76	2.38	2.3	5°

ISO Turning Insert

Inserts Left-hand shown where it's applicable	Product code	RE (mm)	Recommended parameters		Machining conditions																
					● Good condition ● General condition ✖ Bad condition ● ● ● ● ● ● ● ● ● ● ● ● ● ● ● ● ● ●																
			f (mm/rev)	ap (mm)	p				M				K			N	S				
					AT202	AC052P	AC150P	AC250P	AC350P	AC100M	AC200M	AP200U	AP301M	AC100K	AC102K	AC202K	AW100K	AP100S			
Finishing	WBET 0601003FR-F	<0.03	0.05-0.08	0.1-0.8																	
	0601003FL-F	<0.03	0.05-0.08	0.1-0.8										●							
	060101FR-F	<0.1	0.05-0.08	0.1-0.8										●							
	060101FL-F	<0.1	0.05-0.08	0.1-0.8										●							
	060102FR-F	<0.2	0.05-0.08	0.1-0.8										●							
	060102FL-F	<0.2	0.05-0.08	0.1-0.8										●							
	060104FR-F	<0.4	0.05-0.08	0.1-0.8										●							
	060104FL-F	<0.4	0.05-0.08	0.1-0.8										●							
	WBET 0802003FR-F	<0.03	0.05-0.08	0.1-0.8											●						
	0802003FL-F	<0.03	0.05-0.08	0.1-0.8											●						
	080201FR-F	<0.1	0.05-0.08	0.1-0.8											●						
	080201FL-F	<0.1	0.05-0.08	0.1-0.8											●						
	080202FR-F	<0.2	0.05-0.08	0.1-0.8											●						
	080202FL-F	<0.2	0.05-0.08	0.1-0.8											●						
080204FR-F	<0.4	0.05-0.08	0.1-0.8											●							
080204FL-F	<0.4	0.05-0.08	0.1-0.8											●							

●: Stock available ▲: Stock available now but will be replaced in the future.

Positive Round Insert

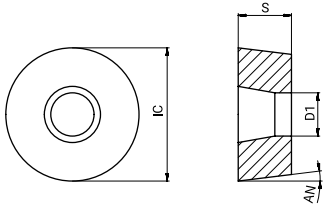

Dimension (mm)				
Product code	IC	S	D1	AN
RCGT_0803_	3.18	8.0	3.4	7°
RCGT_1003_	3.18	10.0	4.4	7°
RCGT_10T3_	3.97	10.0	4.4	7°
RCMX_1003_	3.18	10.0	3.6	7°
RCMX_1204_	4.76	12.0	4.2	7°

Dimension (mm)				
Product code	IC	S	D1	AN
RCMX_1606_	6.35	16.0	5.2	7°
RCMX_2006_	6.35	20.0	6.5	7°
RCMX_2507_	7.94	25.0	7.2	7°
RCMX_3209_	9.525	32.0	9.6	7°

Inserts	Product code	RE (mm)	Recommended parameters		Machining conditions																						
			f (mm/rev)	ap (mm)	p				M				K				N		S								
					AT202	AC052P	AC150P	AC250P	AC350P	AC100M	AC200M	AP200U	AP301M	AC100K	AC102K	AC202K	AW100K	AP100S									
Semi-Finishing	RCGT 0803MOF-NC2	-	0.10-1.00	0.70-3.3																					●		
	1003MOF-NC2	-	0.20-1.30	0.90-4.0																						●	
	10T3MOF-NC2	-	0.20-1.30	0.90-4.0																						●	
	RCMX 2006MOS-PD8	-	0.48-0.90	3.5-9.0			▲	▲																			
	2507MOS-PD8	-	0.55-1.20	4.0-12.0			▲	▲																			
	3209MOS-PD8	-	0.65-1.50	5.0-15.0			▲	▲																			
Medium	RCMX 100300S	-	0.25-0.50	1.5-4.0			▲	▲																			
	120400S	-	0.30-0.60	2.5-5.0	●		▲	▲																			
	160600S	-	0.40-0.75	3.0-7.0	●		▲	▲																			
	200600S	-	0.48-0.90	3.5-9.0	●		▲	▲																			
	250700S	-	0.55-1.20	4.0-12.0	●		▲	▲																			
	320900S	-	0.65-1.50	5.0-15.0	●		▲	▲																			

●: Stock available ▲: Stock available now but will be replaced in the future.

ACHTTECK

www.achtecktool.com/en

THE EXPERT OF DIFFICULT MACHINING



PCD/PCBN Inserts

PCBN Insert Denomination System

CNGA 120408	-	S	010	20	-	SL	-	1	-	CB	PB30
1		2	3	4		5		6		7	8

1-Standard ISO Denomination System

2-Cutting Edge Shape

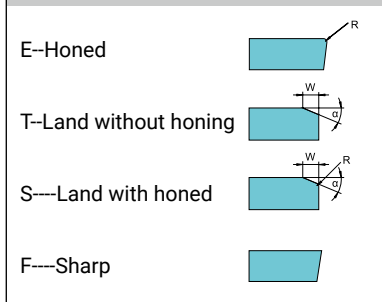

3-T-land Width

005	0.05mm
010	0.10mm
015	0.15mm
020	0.20mm

4-T-land Angle

10	10°
15	15°
20	20°
25	25°

5-CBN Insert Structure

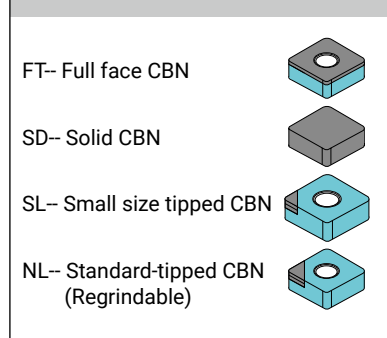

6-Number of Cutting Edge

- 1---One cutting edge
- 2---Two cutting edges
- 3---Three cutting edges

7-Cutting Edge Preparation

- CB---With chip breaker
- WG---With wiper edge
- "-" ---Without chip breaker

8-Grade

- PB30-- Low content CBN
- PB60--Medium content CBN
- PB90--High content CBN

PCBN Insert Grade Introduction

Grade	Feature	Application
PB30	Well balanced wear resistance and shock-resistance	Good versatilely. Suitable for continuous and light interrupted cutting of hardened steel
PB60	Excellent toughness	Mainly applied in medium interrupted cutting of hardened steel, interrupted and continuous cutting of powder metal and cast iron cutting.
PB90	Good wear resistance, toughness, and shock-resistance	K-mainly applied in cast iron cutting H-heavy interrupted cutting of hardened steel and powder metal machining

PCBN Recommended Cutting Parameter

Grade	Material	Hardness	Cutting speed Vc(m/min)	Feed fn(mm/rev)	Cutting depth ap(mm)	Recommended application
PB30	Hardened steel	HRC58-62	150-250	0.03-0.2	0.05-0.3	Continuous
PB60	Hardened steel	HRC55-60	50-150	0.03-0.2	0.05-0.5	Interrupted
	Cast iron	HB180-220	150-450	0.03-0.3	0.30-0.5	Continuous / Interrupted
	Powder metal	-	200-500	0.03-0.3	0.10-0.3	Continuous / Interrupted
PB90	Hardened steel	HRC55-60	30-120	0.03-0.2	0.05-0.5	Heavy interrupted
	Cast iron	HB180-220	150-450	0.03-0.3	0.30-0.5	Continuous / Interrupted
	Powder metal	-	300-800	0.03-0.3	0.10-0.3	Continuous / Interrupted

Grade Application Guide

PCBN grade applications						
Material Group	Materials	ISO	Uncoated			ISO
			PB30	PB60	PB90	
P	unalloy steels / Alloyed steels	P01				P01
		P10				P10
		P20				P20
		P30				P30
		P40				P40
		P50				P50
M	Stainless steels	M01				M01
		M10				M10
		M20				M20
		M30				M30
		M40				M40
K	Cast iron	K01				K01
		K10			PB90	K10
		K20				K20
		K30				K30
		K40				K40
		K50				K50
N	Aluminum/ Aluminum alloys	N01				N01
		N10				N10
		N20				N20
		N30				N30
S	Heat resistant alloys	S01				S01
		S10				S10
		S20				S20
		S30				S30
		S40				S40
H	Hardened steels/ Chilled cast iron	H01	PB30			H01
		H10		PB60		H10
		H20				H20
		H30				H30

PCBN Inserts

Negative 80° (C)

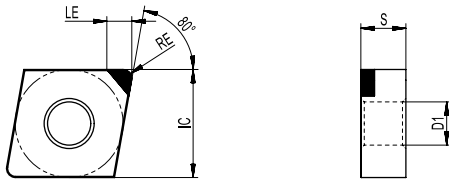

Dimension (mm)				
Product code	IC	S	LE	D1
CN_1204_	12.7	4.76	2.2	5.16

Inserts	Product code	RE (mm)	Recommended parameters		Machining conditions		
			f (mm/rev)	ap (mm)	H		K
					PB30	PB60	PB90
	CNGA 120402-S01020-SL-1	0.2	0.03-0.3	0.05-0.5	●	●	●
	120404-S01020-SL-1	0.4	0.03-0.3	0.05-0.5	●	●	●
	120408-S01020-SL-1	0.8	0.03-0.3	0.05-0.5	●	●	●
	120412-S01020-SL-1	1.2	0.03-0.3	0.05-0.5	●	●	●
	CNGA 120402-S01020-SL-2	0.2	0.03-0.3	0.05-0.5	●	●	●
	120404-S01020-SL-2	0.4	0.03-0.3	0.05-0.5	●	●	●
	120408-S01020-SL-2	0.8	0.03-0.3	0.05-0.5	●	●	●
	120412-S01020-SL-2	1.2	0.03-0.3	0.05-0.5	●	●	●
	CNGA 120402-S01020-SL-4	0.2	0.03-0.3	0.05-0.5	●	●	●
	120404-S01020-SL-4	0.4	0.03-0.3	0.05-0.5	●	●	●
	120408-S01020-SL-4	0.8	0.03-0.3	0.05-0.5	●	●	●
	120412-S01020-SL-4	1.2	0.03-0.3	0.05-0.5	●	●	●

Marked: ● stock available

Negative 55° (D)

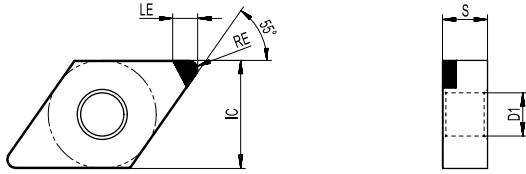

Dimension (mm)				
Product code	IC	S	LE	D1
DN_1504_	12.7	4.76	2.2	5.16
DN_1506_	12.7	6.35	2.2	5.16



Inserts	Product code	RE (mm)	Recommended parameters		Machining conditions		
			f (mm/rev)	ap (mm)	H		K
					PB30	PB60	PB90
	DNGA 150402-S01020-SL-1	0.2	0.03-0.3	0.05-0.5	●	●	●
	150404-S01020-SL-1	0.4	0.03-0.3	0.05-0.5	●	●	●
	150408-S01020-SL-1	0.8	0.03-0.3	0.05-0.5	●	●	●
	150412-S01020-SL-1	1.2	0.03-0.3	0.05-0.5	●	●	●
	150602-S01020-SL-1	0.2	0.03-0.3	0.05-0.5	●	●	●
	150604-S01020-SL-1	0.4	0.03-0.3	0.05-0.5	●	●	●
	150608-S01020-SL-1	0.8	0.03-0.3	0.05-0.5	●	●	●
	150612-S01020-SL-1	1.2	0.03-0.3	0.05-0.5	●	●	●
	DNGA 150402-S01020-SL-2	0.2	0.03-0.3	0.05-0.5	●	●	●
	150404-S01020-SL-2	0.4	0.03-0.3	0.05-0.5	●	●	●
	150408-S01020-SL-2	0.8	0.03-0.3	0.05-0.5	●	●	●
	150412-S01020-SL-2	1.2	0.03-0.3	0.05-0.5	●	●	●
	150602-S01020-SL-2	0.2	0.03-0.3	0.05-0.5	●	●	●
	150604-S01020-SL-2	0.4	0.03-0.3	0.05-0.5	●	●	●
	150608-S01020-SL-2	0.8	0.03-0.3	0.05-0.5	●	●	●
	150612-S01020-SL-2	1.2	0.03-0.3	0.05-0.5	●	●	●
	DNGA 150402-S01020-SL-4	0.2	0.03-0.3	0.05-0.5	●	●	●
	150404-S01020-SL-4	0.4	0.03-0.3	0.05-0.5	●	●	●
	150408-S01020-SL-4	0.8	0.03-0.3	0.05-0.5	●	●	●
	150412-S01020-SL-4	1.2	0.03-0.3	0.05-0.5	●	●	●
	150602-S01020-SL-4	0.2	0.03-0.3	0.05-0.5	●	●	●
	150604-S01020-SL-4	0.4	0.03-0.3	0.05-0.5	●	●	●
	150608-S01020-SL-4	0.8	0.03-0.3	0.05-0.5	●	●	●
	150612-S01020-SL-4	1.2	0.03-0.3	0.05-0.5	●	●	●

PCBN Inserts

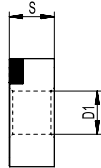
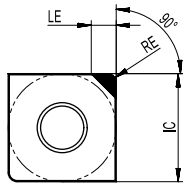
Marked: ● stock available

Negative 90° (S)

Dimension (mm)				
Product code	IC	S	LE	D1
SN_1204_	12.7	4.76	2.2	5.16

Inserts	Product code	RE (mm)	Recommended parameters		Machining conditions		
					● Good condition ◐ General condition ❃ Bad condition		
			f (mm/rev)	ap (mm)	H		K
					PB30	PB60	PB90
	SNGA 120402-S01020-SL-1	0.2	0.03-0.3	0.05-0.5	●	●	●
	120404-S01020-SL-1	0.4	0.03-0.3	0.05-0.5	●	●	●
	120408-S01020-SL-1	0.8	0.03-0.3	0.05-0.5	●	●	●
	120412-S01020-SL-1	1.2	0.03-0.3	0.05-0.5	●	●	●
	SNGA 120402-S01020-SL-4	0.2	0.03-0.3	0.05-0.5	●	●	●
	120404-S01020-SL-4	0.4	0.03-0.3	0.05-0.5	●	●	●
	120408-S01020-SL-4	0.8	0.03-0.3	0.05-0.5	●	●	●
	120412-S01020-SL-4	1.2	0.03-0.3	0.05-0.5	●	●	●
	SNGA 120402-S01020-SL-8	0.2	0.03-0.3	0.05-0.5	●	●	●
	120404-S01020-SL-8	0.4	0.03-0.3	0.05-0.5	●	●	●
	120408-S01020-SL-8	0.8	0.03-0.3	0.05-0.5	●	●	●
	120412-S01020-SL-8	1.2	0.03-0.3	0.05-0.5	●	●	●

Marked: ● stock available

Negative 60° (T)

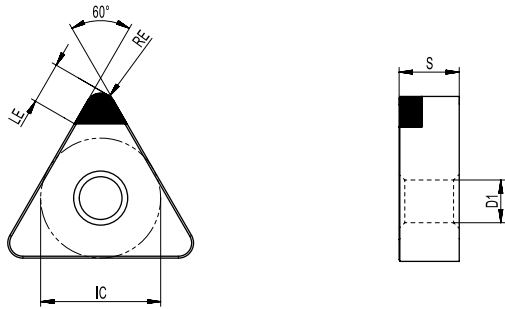

Dimension (mm)				
Product code	IC	S	LE	D1
TN_1604_	9.52	4.76	2.2	3.81

Inserts	Product code	RE (mm)	Recommended parameters		Machining conditions		
			f (mm/rev)	ap (mm)	H		K
					PB30	PB60	PB90
	TNGA 160402-S01020-SL-1	0.2	0.03-0.3	0.05-0.5	●	●	●
	160404-S01020-SL-1	0.4	0.03-0.3	0.05-0.5	●	●	●
	160408-S01020-SL-1	0.8	0.03-0.3	0.05-0.5	●	●	●
	160412-S01020-SL-1	1.2	0.03-0.3	0.05-0.5	●	●	●
	TNGA 160402-S01020-SL-3	0.2	0.03-0.3	0.05-0.5	●	●	●
	160404-S01020-SL-3	0.4	0.03-0.3	0.05-0.5	●	●	●
	160408-S01020-SL-3	0.8	0.03-0.3	0.05-0.5	●	●	●
	160412-S01020-SL-3	1.2	0.03-0.3	0.05-0.5	●	●	●
	TNGA 160402-S01020-SL-6	0.2	0.03-0.3	0.05-0.5	●	●	●
	160404-S01020-SL-6	0.4	0.03-0.3	0.05-0.5	●	●	●
	160408-S01020-SL-6	0.8	0.03-0.3	0.05-0.5	●	●	●
	160412-S01020-SL-6	1.2	0.03-0.3	0.05-0.5	●	●	●

● Good condition ● General condition
 ● Bad condition

PCBN Inserts

Marked: ● stock available

Negative 35° (V)

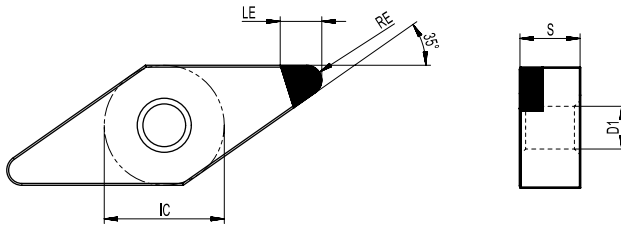

Dimension (mm)				
Product code	IC	S	LE	D1
VN_1604_	9.52	4.76	2.2	3.81

Inserts	Product code	RE (mm)	Recommended parameters		Machining conditions		
			f (mm/rev)	ap (mm)	H		K
					PB30	PB60	PB90
	VNGA 160402-S01020-SL-1	0.2	0.03-0.3	0.05-0.5	●	●	●
	160404-S01020-SL-1	0.4	0.03-0.3	0.05-0.5	●	●	●
	160408-S01020-SL-1	0.8	0.03-0.3	0.05-0.5	●	●	●
	160412-S01020-SL-1	1.2	0.03-0.3	0.05-0.5	●	●	●
	VNGA 160402-S01020-SL-2	0.2	0.03-0.3	0.05-0.5	●	●	●
	160404-S01020-SL-2	0.4	0.03-0.3	0.05-0.5	●	●	●
	160408-S01020-SL-2	0.8	0.03-0.3	0.05-0.5	●	●	●
	160412-S01020-SL-2	1.2	0.03-0.3	0.05-0.5	●	●	●
	VNGA 160402-S01020-SL-4	0.2	0.03-0.3	0.05-0.5	●	●	●
	160404-S01020-SL-4	0.4	0.03-0.3	0.05-0.5	●	●	●
	160408-S01020-SL-4	0.8	0.03-0.3	0.05-0.5	●	●	●
	160412-S01020-SL-4	1.2	0.03-0.3	0.05-0.5	●	●	●

Marked: ● stock available

Negative 80° (W)

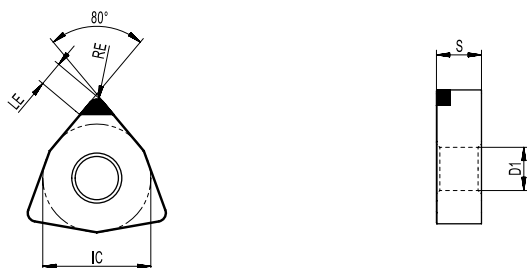

Dimension (mm)				
Product code	IC	S	LE	D1
WN_0804_	12.7	4.76	2.2	5.16

Inserts	Product code	RE (mm)	Recommended parameters		Machining conditions		
			f (mm/rev)	ap (mm)	H		K
					PB30	PB60	PB90
	WNGA 080402-S01020-SL-1	0.2	0.03-0.3	0.05-0.5	●	●	●
	080404-S01020-SL-1	0.4	0.03-0.3	0.05-0.5	●	●	●
	080408-S01020-SL-1	0.8	0.03-0.3	0.05-0.5	●	●	●
	080412-S01020-SL-1	1.2	0.03-0.3	0.05-0.5	●	●	●
	WNGA 080402-S01020-SL-3	0.2	0.03-0.3	0.05-0.5	●	●	●
	080404-S01020-SL-3	0.4	0.03-0.3	0.05-0.5	●	●	●
	080408-S01020-SL-3	0.8	0.03-0.3	0.05-0.5	●	●	●
	080412-S01020-SL-3	1.2	0.03-0.3	0.05-0.5	●	●	●
	WNGA 080402-S01020-SL-6	0.2	0.03-0.3	0.05-0.5	●	●	●
	080404-S01020-SL-6	0.4	0.03-0.3	0.05-0.5	●	●	●
	080408-S01020-SL-6	0.8	0.03-0.3	0.05-0.5	●	●	●
	080412-S01020-SL-6	1.2	0.03-0.3	0.05-0.5	●	●	●

● Good condition ● General condition
✱ Bad condition

PCBN Inserts

Marked: ● stock available

Positive 80° (C)

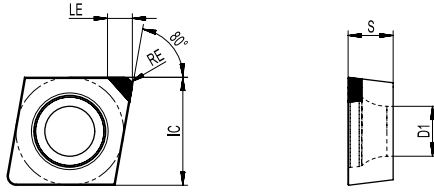

Dimension (mm)				
Product code	IC	S	LE	D1
CC_0602_	6.35	2.38	2.2	2.8
CC_09T3_	9.52	3.97	2.2	4.4
CC_1204_	12.7	4.76	2.2	5.5

Inserts	Product code	RE (mm)	Recommended parameters		Machining conditions		
			f (mm/rev)	ap (mm)	H		K
					PB30	PB60	PB90
	CCGW 060202-S01020-SL-1	0.2	0.03-0.3	0.05-0.5	●	●	●
	060204-S01020-SL-1	0.4	0.03-0.3	0.05-0.5	●	●	●
	060208-S01020-SL-1	0.8	0.03-0.3	0.05-0.5	●	●	●
	09T302-S01020-SL-1	0.2	0.03-0.3	0.05-0.5	●	●	●
	09T304-S01020-SL-1	0.4	0.03-0.3	0.05-0.5	●	●	●
	09T308-S01020-SL-1	0.8	0.03-0.3	0.05-0.5	●	●	●
	120402-S01020-SL-1	0.2	0.03-0.3	0.05-0.5	●	●	●
	120404-S01020-SL-1	0.4	0.03-0.3	0.05-0.5	●	●	●
	120408-S01020-SL-1	0.8	0.03-0.3	0.05-0.5	●	●	●
	120412-S01020-SL-1	1.2	0.03-0.3	0.05-0.5	●	●	●
	CCGW 060202-S01020-SL-2	0.2	0.03-0.3	0.05-0.5	●	●	●
	060204-S01020-SL-2	0.4	0.03-0.3	0.05-0.5	●	●	●
	060208-S01020-SL-2	0.8	0.03-0.3	0.05-0.5	●	●	●
	09T302-S01020-SL-2	0.2	0.03-0.3	0.05-0.5	●	●	●
	09T304-S01020-SL-2	0.4	0.03-0.3	0.05-0.5	●	●	●
	09T308-S01020-SL-2	0.8	0.03-0.3	0.05-0.5	●	●	●
	120402-S01020-SL-2	0.2	0.03-0.3	0.05-0.5	●	●	●
	120404-S01020-SL-2	0.4	0.03-0.3	0.05-0.5	●	●	●
	120408-S01020-SL-2	0.8	0.03-0.3	0.05-0.5	●	●	●
	120412-S01020-SL-2	1.2	0.03-0.3	0.05-0.5	●	●	●

Marked: ● stock available

Positive 55° (D)

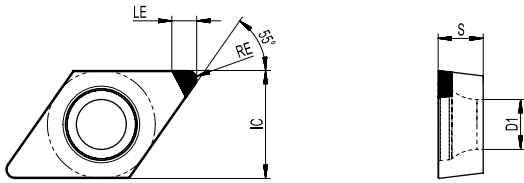

Dimension (mm)				
Product code	IC	S	LE	D1
DC_0702_	6.35	2.38	2.2	2.8
DC_11T3_	9.52	3.97	2.2	4.4

Inserts	Product code	RE (mm)	Recommended parameters		Machining conditions		
			f (mm/rev)	ap (mm)	H		K
					PB30	PB60	PB90
	DCGW 070204-S01020-SL-1	0.4	0.03-0.3	0.05-0.5	●	●	●
	070208-S01020-SL-1	0.8	0.03-0.3	0.05-0.5	●	●	●
	11T302-S01020-SL-1	0.2	0.03-0.3	0.05-0.5	●	●	●
	11T304-S01020-SL-1	0.4	0.03-0.3	0.05-0.5	●	●	●
	11T308-S01020-SL-1	0.8	0.03-0.3	0.05-0.5	●	●	●
	11T312-S01020-SL-1	1.2	0.03-0.3	0.05-0.5	●	●	●
	DCGW 070202-S01020-SL-2	0.2	0.03-0.3	0.05-0.5	●	●	●
	070204-S01020-SL-2	0.4	0.03-0.3	0.05-0.5	●	●	●
	070208-S01020-SL-2	0.8	0.03-0.3	0.05-0.5	●	●	●
	11T302-S01020-SL-2	0.2	0.03-0.3	0.05-0.5	●	●	●
	11T304-S01020-SL-2	0.4	0.03-0.3	0.05-0.5	●	●	●
	11T308-S01020-SL-2	0.8	0.03-0.3	0.05-0.5	●	●	●
	11T312-S01020-SL-2	1.2	0.03-0.3	0.05-0.5	●	●	●



PCBN Inserts

Marked: ● stock available

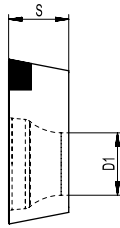
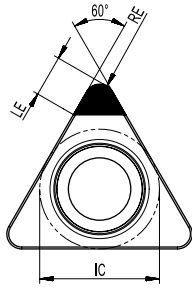
Positive 60° (T)

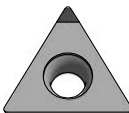

Dimension (mm)				
Product code	IC	S	LE	D1
TP_0802_	4.76	2.38	2.2	2.4
TP_0902_	5.56	2.38	2.2	2.8
TP_1103_	6.35	3.18	2.2	3.3
TP_1604_	9.52	4.76	2.2	4.4

Inserts	Product code	RE (mm)	Recommended parameters		Machining conditions		
			f (mm/rev)	ap (mm)	H		K
					PB30	PB60	PB90
	TPGW 080202-S01020-SL-1	0.2	0.03-0.3	0.05-0.5	●	●	●
	080204-S01020-SL-1	0.4	0.03-0.3	0.05-0.5	●	●	●
	090202-S01020-SL-1	0.2	0.03-0.3	0.05-0.5	●	●	●
	090204-S01020-SL-1	0.4	0.03-0.3	0.05-0.5	●	●	●
	090208-S01020-SL-1	0.8	0.03-0.3	0.05-0.5	●	●	●
	110302-S01020-SL-1	0.2	0.03-0.3	0.05-0.5	●	●	●
	110304-S01020-SL-1	0.4	0.03-0.3	0.05-0.5	●	●	●
	160402-S01020-SL-1	0.2	0.03-0.3	0.05-0.5	●	●	●
	160404-S01020-SL-1	0.4	0.03-0.3	0.05-0.5	●	●	●
	160408-S01020-SL-1	0.8	0.03-0.3	0.05-0.5	●	●	●
	TPGW 080202-S01020-SL-3	0.2	0.03-0.3	0.05-0.5	●	●	●
	080204-S01020-SL-3	0.4	0.03-0.3	0.05-0.5	●	●	●
	090202-S01020-SL-3	0.2	0.03-0.3	0.05-0.5	●	●	●
	090204-S01020-SL-3	0.4	0.03-0.3	0.05-0.5	●	●	●
	090208-S01020-SL-3	0.8	0.03-0.3	0.05-0.5	●	●	●
	110302-S01020-SL-3	0.2	0.03-0.3	0.05-0.5	●	●	●
	110304-S01020-SL-3	0.4	0.03-0.3	0.05-0.5	●	●	●
	160402-S01020-SL-3	0.2	0.03-0.3	0.05-0.5	●	●	●
	160404-S01020-SL-3	0.4	0.03-0.3	0.05-0.5	●	●	●
	160408-S01020-SL-3	0.8	0.03-0.3	0.05-0.5	●	●	●

Marked: ● stock available

Positive 35° (V)

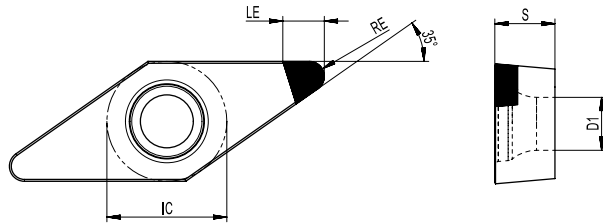

Dimension (mm)				
Product code	IC	S	LE	D1
VB_1103_	6.35	3.18	2.2	2.8
VC_1103_	6.35	3.18	2.2	2.8
VB_1604_	9.52	4.76	2.2	4.4
VC_1604_	9.52	4.76	2.2	4.4



Inserts	Product code	RE (mm)	Recommended parameters		Machining conditions		
			f (mm/rev)	ap (mm)	H		K
					PB30	PB60	PB90
	VBGW 110302-S01020-SL-1	0.2	0.03-0.3	0.05-0.5	●	●	●
	110304-S01020-SL-1	0.4	0.03-0.3	0.05-0.5	●	●	●
	110308-S01020-SL-1	0.8	0.03-0.3	0.05-0.5	●	●	●
	160402-S01020-SL-1	0.2	0.03-0.3	0.05-0.5	●	●	●
	160404-S01020-SL-1	0.4	0.03-0.3	0.05-0.5	●	●	●
	160408-S01020-SL-1	0.8	0.03-0.3	0.05-0.5	●	●	●
	VBGW 110302-S01020-SL-2	0.2	0.03-0.3	0.05-0.5	●	●	●
	110304-S01020-SL-2	0.4	0.03-0.3	0.05-0.5	●	●	●
	110308-S01020-SL-2	0.8	0.03-0.3	0.05-0.5	●	●	●
	160402-S01020-SL-2	0.2	0.03-0.3	0.05-0.5	●	●	●
	160404-S01020-SL-2	0.4	0.03-0.3	0.05-0.5	●	●	●
	160408-S01020-SL-2	0.8	0.03-0.3	0.05-0.5	●	●	●
	VCGW 110302-S01020-SL-1	0.2	0.03-0.3	0.05-0.5	●	●	●
	110304-S01020-SL-1	0.4	0.03-0.3	0.05-0.5	●	●	●
	110308-S01020-SL-1	0.8	0.03-0.3	0.05-0.5	●	●	●
	160402-S01020-SL-1	0.2	0.03-0.3	0.05-0.5	●	●	●
	160404-S01020-SL-1	0.4	0.03-0.3	0.05-0.5	●	●	●
	160408-S01020-SL-1	0.8	0.03-0.3	0.05-0.5	●	●	●
	VCGW 110302-S01020-SL-2	0.2	0.03-0.3	0.05-0.5	●	●	●
	110304-S01020-SL-2	0.4	0.03-0.3	0.05-0.5	●	●	●
	110308-S01020-SL-2	0.8	0.03-0.3	0.05-0.5	●	●	●
	160402-S01020-SL-2	0.2	0.03-0.3	0.05-0.5	●	●	●
	160404-S01020-SL-2	0.4	0.03-0.3	0.05-0.5	●	●	●
	160408-S01020-SL-2	0.8	0.03-0.3	0.05-0.5	●	●	●

PCBN Inserts

Marked: ● stock available

PCD Insert Denomination System

CCGW 09T304	-	2	-	NL	-	5	-	CB	PD20
1		2		3		4		5	6

<p>1-Standard ISO Denomination system</p>	<p>2-Number of Cutting Edge</p> <p>1--One cutting edge 2--Two cutting edges 3--Three cutting edges</p>	<p>3-PCD Insert Structure</p> <p>NL--Standard structure with tipped PCD </p> <p>LL-- Full edge tipped PCD </p>	<p>4-Rake Angle</p> <p>00--0° 05--5° 07--7° 10--10°</p>
<p>5-Cutting Edge Preparation</p> <p>CB-- With chip breaker WG--With wiper edge "- " Without chip breaker</p>	<p>6-Grade</p> <p>PD01---Fine grain PCD PD10---Medium grain PCD PD20---Coarse grain PCD</p>		

PCD Insert Grade Introduction

Grade	Feature	Application
PD20	Universal grade, balanced wear resistance and toughness	1st choice for general machining of aluminum alloys

PCD Recommended Cutting Parameter

Grade	Material	Cutting speed Vc(m/min)	Feed f(mm/rev)	Cutting depth ap(mm)	Recommended application
PD20	Low-Si Aluminium Alloy (Si < 12%)	300-4000	0.03-0.2	0.05-0.5	Continuous/interrupted

Grade Application Guide

PCD insert applications				
Material Group	Materials	ISO	Uncoated	ISO
			PD20	
P	unalloy steels / Alloyed steels	P01		P01
		P10		P10
		P20		P20
		P30		P30
		P40		P40
		P50		P50
M	Stainless steels	M01		M01
		M10		M10
		M20		M20
		M30		M30
		M40		M40
K	Cast iron	K01		K01
		K10		K10
		K20		K20
		K30		K30
		K40		K40
		K50		K50
N	Aluminum/ Aluminum alloys	N01	PD20	N01
		N10		N10
		N20		N20
		N30		N30
S	Heat resistant alloys	S01		S01
		S10		S10
		S20		S20
		S30		S30
		S40		S40
H	Hardened steels/ Chilled cast iron	H01		H01
		H10		H10
		H20		H20
		H30		H30

PCD Inserts

Negative 80° (C)

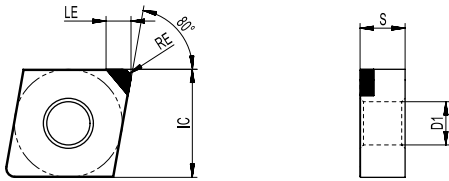

Dimension (mm)				
Product code	IC	S	LE	D1
CN_1204_	12.7	4.76	3.0	5.16

Inserts	Product code	RE (mm)	Machining conditions		● Good condition
			Recommended parameters		●
			f (mm/rev)	ap (mm)	N
	CNGA 120402-1-NL-00	0.2	0.03-0.2	0.05-0.5	●
	120404-1-NL-00	0.4	0.03-0.2	0.05-0.5	●
	120408-1-NL-00	0.8	0.03-0.2	0.05-0.5	●

Negative 55° (D)

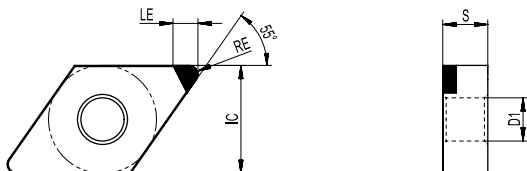

Dimension (mm)				
Product code	IC	S	LE	D1
DN_1504_	12.7	4.76	3.0	5.16

Inserts	Product code	RE (mm)	Machining conditions		● Good condition
			Recommended parameters		●
			f (mm/rev)	ap (mm)	N
	DNGA 150402-1-NL-00	0.2	0.03-0.2	0.05-0.5	●
	150404-1-NL-00	0.4	0.03-0.2	0.05-0.5	●
	150408-1-NL-00	0.8	0.03-0.2	0.05-0.5	●

Marked: ● stock available

Negative 60° (T)

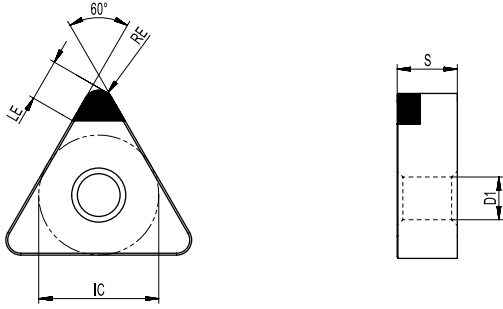

Dimension (mm)				
Product code	IC	S	LE	D1
TN_1604_	9.52	4.76	3.0	3.81

Inserts	Product code	RE (mm)	Machining conditions		● Good condition
			Recommended parameters		●
			f (mm/rev)	ap (mm)	N
	TNGA 160402-1-NL-00	0.2	0.03-0.2	0.05-0.5	●
	160404-1-NL-00	0.4	0.03-0.2	0.05-0.5	●
	160408-1-NL-00	0.8	0.03-0.2	0.05-0.5	●

PCD Inserts

Negative 35° (V)

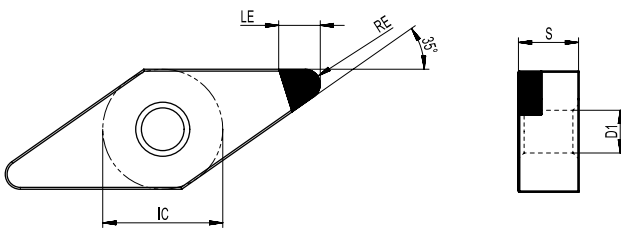

Dimension (mm)				
Product code	IC	S	LE	D1
VN_1604_	9.525	4.76	3.0	3.81

Inserts	Product code	RE (mm)	Machining conditions		● Good condition
			Recommended parameters		●
			f (mm/rev)	ap (mm)	N
	VNGA 160402-1-NL-00	0.2	0.03-0.2	0.05-0.5	●
	160404-1-NL-00	0.4	0.03-0.2	0.05-0.5	●
	160408-1-NL-00	0.8	0.03-0.2	0.05-0.5	●

Marked: ● stock available

Positive 80° (C)

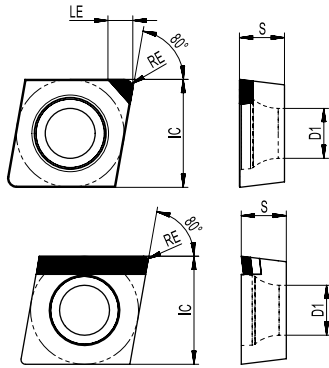

Dimension (mm)				
Product code	IC	S	LE	D1
CC_0602_	6.35	2.38	3.0	2.8
CC_09T3_	9.52	3.97	3.0	4.4
CC_1204_	12.7	4.76	3.0	5.5

Inserts	Product code	RE (mm)	Rake angle (°)	Machining conditions		● Good condition
				Recommended parameters		●
				f (mm/rev)	ap (mm)	N
						PD20
	CCGW 060202-1-NL-00	0.2	0°	0.03-0.2	0.05-0.5	●
	060204-1-NL-00	0.4	0°	0.03-0.2	0.05-0.5	●
	09T302-1-NL-00	0.2	0°	0.03-0.2	0.05-0.5	●
	09T304-1-NL-00	0.4	0°	0.03-0.2	0.05-0.5	●
	09T308-1-NL-00	0.8	0°	0.03-0.2	0.05-0.5	●
	CCGW 060202-1-NL-05	0.2	5°	0.03-0.2	0.05-0.5	●
	060204-1-NL-05	0.4	5°	0.03-0.2	0.05-0.5	●
	09T302-1-NL-05	0.2	5°	0.03-0.2	0.05-0.5	●
	09T304-1-NL-05	0.4	5°	0.03-0.2	0.05-0.5	●
	09T308-1-NL-05	0.8	5°	0.03-0.2	0.05-0.5	●
	120402-1-NL-05	0.2	5°	0.03-0.2	0.05-0.5	●
	120404-1-NL-05	0.4	5°	0.03-0.2	0.05-0.5	●
120408-1-NL-05	0.8	5°	0.03-0.2	0.05-0.5	●	
	CCGW 060202L-1-LL-07	0.2	7°	0.03-0.2	0.05-0.5	●
	060202R-1-LL-07	0.2	7°	0.03-0.2	0.05-0.5	●
	060204L-1-LL-07	0.4	7°	0.03-0.2	0.05-0.5	●
	060204R-1-LL-07	0.4	7°	0.03-0.2	0.05-0.5	●
	09T302L-1-LL-07	0.2	7°	0.03-0.2	0.05-0.5	●
	09T302R-1-LL-07	0.2	7°	0.03-0.2	0.05-0.5	●
	09T304L-1-LL-07	0.4	7°	0.03-0.2	0.05-0.5	●
	09T304R-1-LL-07	0.4	7°	0.03-0.2	0.05-0.5	●
	120404L-1-LL-07	0.4	7°	0.03-0.2	0.05-0.5	●
	120404R-1-LL-07	0.4	7°	0.03-0.2	0.05-0.5	●
	120408L-1-LL-07	0.8	7°	0.03-0.2	0.05-0.5	●
	120408R-1-LL-07	0.8	7°	0.03-0.2	0.05-0.5	●

Marked: ● stock available

Positive 55° (D)

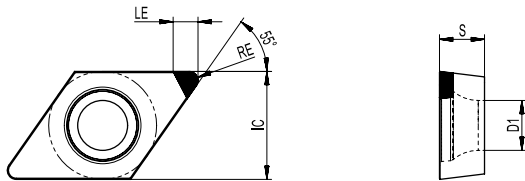

Dimension (mm)				
Product code	IC	S	LE	D1
DC_0702_	6.35	2.38	3.0	2.8
DC_11T3_	9.52	3.97	3.0	4.4

Inserts	Product code	RE (mm)	Rake angle (°)	Machining conditions		● Good condition
				Recommended parameters		●
				f (mm/rev)	ap (mm)	N
	DCGW 070202-1-NL-00	0.2	0°	0.03-0.2	0.05-0.5	●
	070204-1-NL-00	0.4	0°	0.03-0.2	0.05-0.5	●
	070208-1-NL-00	0.8	0°	0.03-0.2	0.05-0.5	●
	070202-1-NL-05	0.2	5°	0.03-0.2	0.05-0.5	●
	070204-1-NL-05	0.4	5°	0.03-0.2	0.05-0.5	●
	070208-1-NL-05	0.8	5°	0.03-0.2	0.05-0.5	●
	DCGW 11T302-1-NL-05	0.2	5°	0.03-0.2	0.05-0.5	●
	11T304-1-NL-05	0.4	5°	0.03-0.2	0.05-0.5	●
	11T308-1-NL-05	0.8	5°	0.03-0.2	0.05-0.5	●

PCD Inserts

Positive 90° (S)

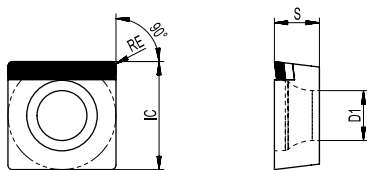

Dimension (mm)				
Product code	IC	S	LE	D1
SC_0602_	6.35	2.38	3.0	2.8
SC_09T3_	9.52	3.97	3.0	4.4
SC_1204_	12.7	4.76	3.0	5.5

Inserts	Product code	RE (mm)	Rake angle (°)	Machining conditions		● Good condition
				Recommended parameters		●
				f (mm/rev)	ap (mm)	N
	SCGW 060204-1-LL-07	0.4	7°	0.03-0.2	0.05-0.5	●
	09T304-1-LL-07	0.4	7°	0.03-0.2	0.05-0.5	●
	09T308-1-LL-07	0.8	7°	0.03-0.2	0.05-0.5	●
	120404-1-LL-07	0.4	7°	0.03-0.2	0.05-0.5	●
	120408-1-LL-07	0.8	7°	0.03-0.2	0.05-0.5	●

Marked: ● stock available

Positive 60° (T)

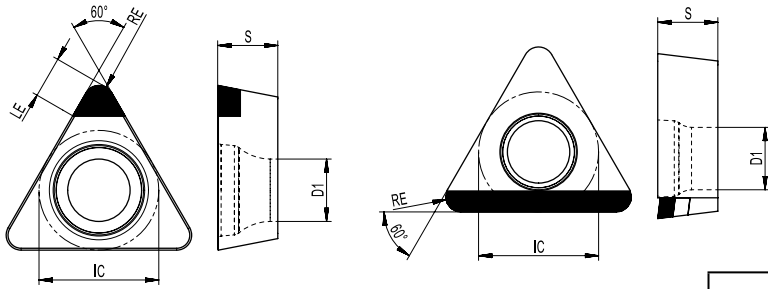

Dimension (mm)				
Product code	IC	S	LE	D1
TB_0601_	3.97	1.59	2.0	2.2
TC_0802_	4.76	2.38	3.0	2.4
TC_0902_	5.56	2.38	3.0	2.8
TC_1102_	6.35	2.38	3.0	2.8
TC_1103_	6.35	3.18	3.0	2.8
TC_16T3_	9.52	3.97	3.0	4.4
TP_0802_	4.76	2.38	3.0	2.4
TP_0902_	5.56	2.38	3.0	2.8
TP_1604_	9.52	4.76	3.0	4.4



Inserts	Product code	RE (mm)	Rake angle (°)	Machining conditions		● Good condition
				Recommended parameters		●
				f (mm/rev)	ap (mm)	N
	TBGW 060102-1-NL-05	0.2	5°	0.03-0.2	0.05-0.5	●
	060104-1-NL-05	0.4	5°	0.03-0.2	0.05-0.5	●
	TCGW 110202-1-NL-00	0.2	0°	0.03-0.2	0.05-0.5	●
	110204-1-NL-00	0.4	0°	0.03-0.2	0.05-0.5	●
	110302-1-NL-00	0.2	0°	0.03-0.2	0.05-0.5	●
	110304-1-NL-00	0.4	0°	0.03-0.2	0.05-0.5	●
	110308-1-NL-00	0.8	0°	0.03-0.2	0.05-0.5	●
	TCGW 110202-1-NL-05	0.2	5°	0.03-0.2	0.05-0.5	●
	110204-1-NL-05	0.4	5°	0.03-0.2	0.05-0.5	●
	110302-1-NL-05	0.2	5°	0.03-0.2	0.05-0.5	●
	110304-1-NL-05	0.4	5°	0.03-0.2	0.05-0.5	●
	110308-1-NL-05	0.8	5°	0.03-0.2	0.05-0.5	●
	16T302-1-NL-05	0.2	5°	0.03-0.2	0.05-0.5	●
	16T304-1-NL-05	0.4	5°	0.03-0.2	0.05-0.5	●
16T308-1-NL-05	0.8	5°	0.03-0.2	0.05-0.5	●	
	TPGW 080202-1-NL-00	0.2	0°	0.03-0.2	0.05-0.5	●
	080204-1-NL-00	0.4	0°	0.03-0.2	0.05-0.5	●
	090202-1-NL-00	0.2	0°	0.03-0.2	0.05-0.5	●
	090204-1-NL-00	0.4	0°	0.03-0.2	0.05-0.5	●
	TPGW 080202-1-NL-05	0.2	5°	0.03-0.2	0.05-0.5	●
	080204-1-NL-05	0.4	5°	0.03-0.2	0.05-0.5	●
	090202-1-NL-05	0.2	5°	0.03-0.2	0.05-0.5	●
	090204-1-NL-05	0.4	5°	0.03-0.2	0.05-0.5	●
	160402-1-NL-05	0.2	5°	0.03-0.2	0.05-0.5	●
	160404-1-NL-05	0.4	5°	0.03-0.2	0.05-0.5	●
	160408-1-NL-05	0.8	5°	0.03-0.2	0.05-0.5	●
	TCGW 090202-1-LL-07	0.2	7°	0.03-0.2	0.05-0.5	●
	090204-1-LL-07	0.4	7°	0.03-0.2	0.05-0.5	●
	110202-1-LL-07	0.2	7°	0.03-0.2	0.05-0.5	●
	110204-1-LL-07	0.4	7°	0.03-0.2	0.05-0.5	●
	16T304-1-LL-07	0.4	7°	0.03-0.2	0.05-0.5	●
	16T308-1-LL-07	0.8	7°	0.03-0.2	0.05-0.5	●

Marked: ● stock available

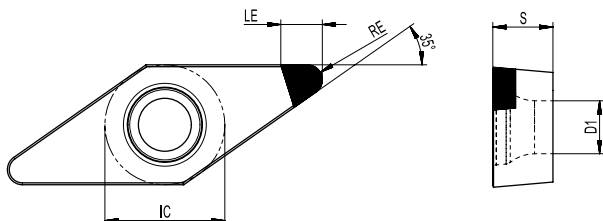
Positive 35° (V)



Dimension (mm)				
Product code	IC	S	LE	D1
VB_1103_	6.35	3.18	3.0	2.8
VB_1604_	9.52	4.76	3.0	4.4

Inserts	Product code	RE (mm)	Rake angle (°)	Machining conditions		● Good condition
				Recommended parameters		●
				f (mm/rev)	ap (mm)	N
	VBGW 110302-1-NL-05	0.2	5°	0.03-0.2	0.05-0.5	●
	110304-1-NL-05	0.4	5°	0.03-0.2	0.05-0.5	●
	160402-1-NL-05	0.2	5°	0.03-0.2	0.05-0.5	●
	160404-1-NL-05	0.4	5°	0.03-0.2	0.05-0.5	●
	VCGW 110302-1-NL-05	0.2	5°	0.03-0.2	0.05-0.5	●
	110304-1-NL-05	0.4	5°	0.03-0.2	0.05-0.5	●
	160402-1-NL-05	0.2	5°	0.03-0.2	0.05-0.5	●
	160404-1-NL-05	0.4	5°	0.03-0.2	0.05-0.5	●

PCD Inserts

Marked: ● stock available

ACHTECK

www.achtecktool.com/en

THE EXPERT OF DIFFICULT MACHINING



Small Tools

Turning Shank Denomination System

S 1	C 2	L 3	C 4	R 5
---------------	---------------	---------------	---------------	---------------

1-Clamping Type				
C: Top clamp 	M: Top wedge clamping 	D: Rigid clamping 	P: lever clamping 	S: Screw clamping

2-Insert Shape									
C 80°	D 55°	H 120°	K 55°	O 135°	R 360°	S 90°	T 60°	V 35°	W 80°

3-Approaching Angle									
A 90°	J 93°	T 60°	E 60°	N 62°30'	H 107°30'	S 45°	D 45°	M 50°	W 60°
R 75°	C 90°	L 95°	V 72°30'	G 90°	B 75°	K 75°	U 93°	F 90°	X Special Approaching angle, explanation needed.

4-Clearance Angle							
B 5°	C 7°	D 15°	E 20°	F 25°	N 0°	P 11°	O Other clearance angle

12
6

12
7

JX
8

09
9

F
10

5-Hand of Tool	
L Left hand	
R Right hand	
N Neutral	

6 -Width of Shank (mm)	
	06=6
	08=8
	10=10
	12=12
	14=14
	16=16
	20=20
	25=25
	30=30
	40=40
50=50	

7 -Center Height of Tool (mm)	
	06=6
	08=8
	10=10
	12=12
	14=14
	16=16
	20=20
	25=25
	30=30
	40=40
50=50	

Small Tools

8 -Tool Length (mm)	
A=32	M=150
B=40	N=160
C=50	P=170
D=60	Q=180
E=70	R=200
F=80	S=250
FX=85	T=300
G=90	U=350
H=100	V=400
J=110	W=450
JX=120	Y=500
K=125	
L=140	X=Special

9 -Length of Cutting Edge			
C, D, E, M, V		H	O
R	S	T	W

10 - Added Symbol	
F	Without Offset
J	With high pressure coolant

SCLC External Turning Shank - Without Offset

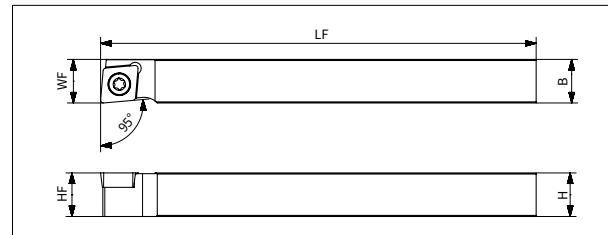

Product code	Dimension (mm)						Stock		Spare parts	
	H	B	HF	LF	LH	WF	R	L	Screw	Wrench
SCLCR/L 0808F-06F	8	8	8	80	-	8	●	●	SP025065	FT-TP08
SCLCR/L 1010JX-06F	10	10	10	120	-	10	●	●		
SCLCR/L 1010JX-09F	10	10	10	120	15	10	●	●	SP040090-X	FT-TP15
SCLCR/L 1212F-09F	12	12	12	80	-	12	●	●		
SCLCR/L 1212JX-09F	12	12	12	120	-	12	●	●		
SCLCR/L 1616JX-09F	16	16	16	120	-	16	●	●		

SCLC External Turning Shank - With Offset

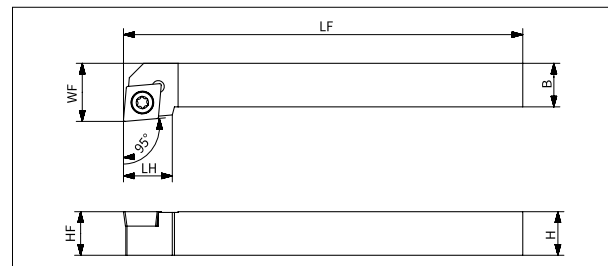

Product code	Dimension (mm)						Stock		Spare parts	
	H	B	HF	LF	LH	WF	R	L	Screw	Wrench
SCLCR/L 1010F-06	10	10	10	80	9	12	●	●	SP025065	FT-TP08
SCLCR/L 1010F-09	10	10	10	80	14	14	●	●	SP040090-X	FT-TP15
SCLCR/L 1212H-09	12	12	12	100	14	16	●	●		
SCLCR/L 1616H-09	16	16	16	100	15	20	●	●		

Applicable Insert

Applicaiton	Finishing	Finishing	Finishing	Semi-finishing–Finishing
Insert Shape	F	M	LF	UF
Holder Type				
SCLCR/L.....06/06F	CCET 0602	CCET 0602	CCGT 0602	CCGT 0602
SCLCR/L.....09/09F	CCET 09T3	CCET 09T3	CCGT 09T3	CCGT 09T3
Reference page	P73	P73	P70	P70

●: Stock available ▲: Stock available now but will be replaced in the future.

SDJC External Turning Shank - Without Offset

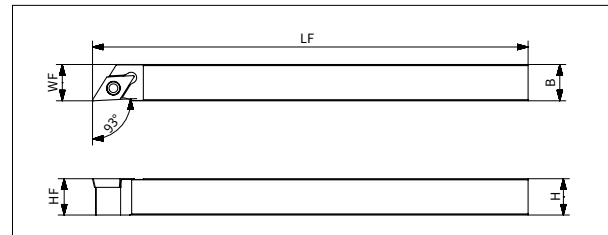

Product code	Dimension (mm)							Stock		Spare parts	
	H	B	HF	LF	LH	WF	HBKW	R	L	Screw	Wrench
SDJCR/L 0808F-07F	8	8	8	80	14	8	0.5	●	●	SP025065	FT-TP08
SDJCR/L 1010JX-07F	10	10	10	120	-	10	-	●	●		
SDJCR/L 1010JX-11F	10	10	10	120	20	10	3	●	●	SP040090-X	FT-TP15
SDJCR/L 1212F-11F	12	12	12	80	20	12	1	●	●		
SDJCR/L 1212JX-11F	12	12	12	120	20	12	1	●	●		
SDJCR/L 1616JX-11F	16	16	16	120	-	16	-	●	●		

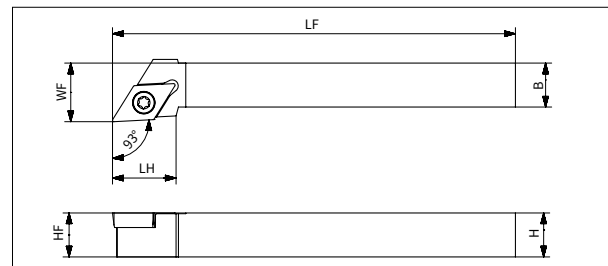

Small Tools

SDJC External Turning Shank - With Offset



Product code	Dimension (mm)							Stock		Spare parts	
	H	B	HF	LF	LH	WF	HBKW	R	L	Screw	Wrench
SDJCR/L 1010F-07	10	10	10	80	12	12	-	●	●	SP025065	FT-TP08
SDJCR/L 1010F-11	10	10	10	80	18	12	3	●	●	SP040090-X	FT-TP15
SDJCR/L 1212H-11	12	12	12	100	18	16	1	●	●		
SDJCR/L 1616H-11	16	16	16	100	18	20	-	●	●		

Applicable Insert

Applicaiton	Finishing	Finishing	Finishing	Semi-finishing–Finishing
Insert Shape	F	M	LF	UF
Holder Type				
SDJCR/L.....07/07F	DCET 0702	DCET 0702	DCGT 0702	DCGT 0702
SDJCR/L.....11/11F	DCET 11T3	DCET 11T3	DCGT 11T3	DCGT 11T3
Reference page	P76	P77	P74	P74

●: Stock available ▲: Stock available now but will be replaced in the future.

SDLC External Turning Shank - Without Offset

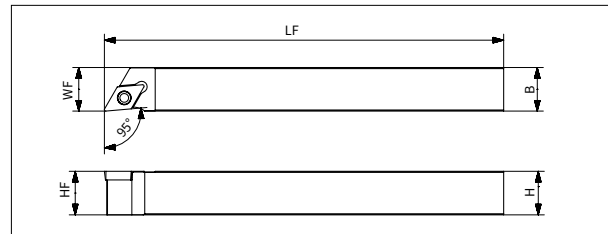



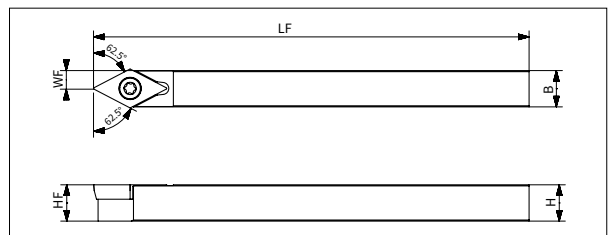

Product code	Dimension (mm)							Stock		Spare parts	
	H	B	HF	LF	LH	WF	HBKW	R	L	Screw	Wrench
SDLCR/L 1010JX-07F	10	10	10	120	-	10	-	●	●	SP025065	FT-TP08
SDLCR/L 1212F-07F	12	12	12	80	-	12	-	●	●		
SDLCR/L 1212JX-07F	12	12	12	120	-	12	-	●	●		
SDLCR/L 1616JX-07F	16	16	16	120	-	16	-	●	●		
SDLCR 1010F-11F	10	10	10	80	-	10	4	●	-	SP040090-X	FT-TP15
SDLCR/L 1010JX-11F	10	10	10	120	-	10	4	●	●		
SDLCR 1212F-11F	12	12	12	80	-	12	2	●	-		
SDLCR/L 1212JX-11F	12	12	12	120	-	12	2	●	●		
SDLCR 1616H-11F	16	16	16	100	-	16	-	●	-		
SDLCR/L 1616JX-11F	16	16	16	120	-	16	-	●	●		

SDNC External Turning Shank - Neutral



Product code	Dimension (mm)							Stock	Spare parts	
	H	B	HF	LF	LH	WF	HBKW	N	Screw	Wrench
SDNCN 0808F-07	8	8	8	80	-	4	-	●	SP025065	FT-TP08
SDNCN 1010JX-07	10	10	10	120	-	5	-	●		
SDNCN 1212JX-07	12	12	12	120	-	6	-	●		
SDNCN 1010F-11	10	10	10	80	-	5	-	●	SP040090-X	FT-TP15
SDNCN 1010JX-11	10	10	10	120	-	5	-	●		
SDNCN 1212F-11	12	12	12	80	-	6	-	●		
SDNCN 1212JX-11	12	12	12	120	-	6	-	●		
SDNCN 1616H-11	16	16	16	100	-	8	-	●		
SDNCN 1616JX-11	16	16	16	120	-	8	-	●		

Applicable Insert

Applicaition	Finishing	Finishing	Finishing	Semi-finishing–Finishing
Insert Shape	F	M	LF	UF
Holder Type				
SDLCR/L....07F SDNCN07	DCET 0702	DCET 0702	DCGT 0702	DCGT 0702
SDLCR/L....11F SDNCN11	DCET 11T3	DCET 11T3	DCGT 11T3	DCGT 11T3
Reference page	P76	P77	P74	P74

●: Stock available ▲: Stock available now but will be replaced in the future.

STGC/STGP External Turning Shank - With Offset

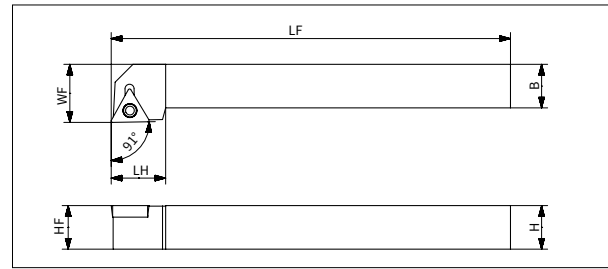

Product code	Dimension (mm)						Stock		Spare parts	
	H	B	HF	LF	LH	WF	R	L	Screw	Wrench
STGCR 0808F-08	8	8	8	80	12	10	●	-	SP020049	FT-TP06
STGCR/L 1010F-11	10	10	10	80	15	14	●	●	SP025065	FT-TP08
STGCR/L 1212H-11	12	12	12	100	15	16	●	●		
STGCR/L 1616H-11	16	16	16	100	15	20	●	●		
STGPR 0808F-08	8	8	8	80	12	10	●	-	SP020049	FT-TP06
STGPR/L 1010F-11	10	10	10	80	15	14	●	●	SP030082	FT-TP09
STGPR/L 1212H-11	12	12	12	100	15	16	●	●		
STGPR/L 1616H-11	16	16	16	100	15	20	●	●		

Small Tools

Applicable Insert

Applicaiton	Finishing	Finishing
Holder Type	F	M
	Insert Shape	
STGCR 0808F-08	-	TCET 0802
STGPR 0808F-08	TPEH 0802	-
STGC... -11	-	TCET 1103
STGP... -11	TPEH 1103	-
Reference page	P82、 83	P83

●: Stock available ▲: Stock available now but will be replaced in the future.

SVJB External Turning Shank - Without Offset

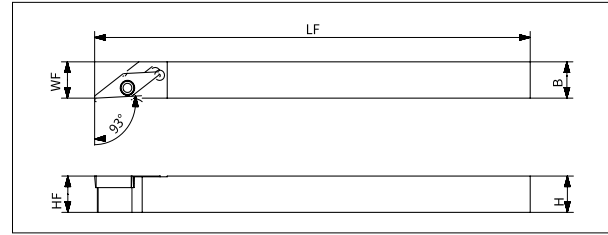



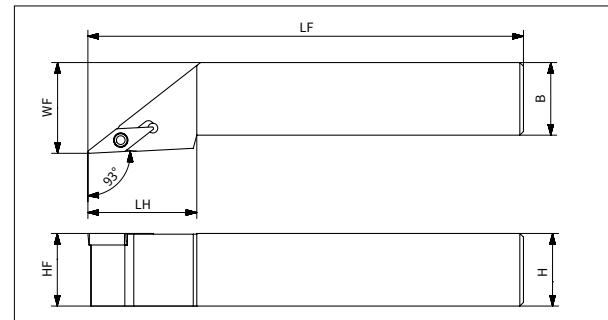

Product code	Dimension (mm)						Stock		Spare parts	
	H	B	HF	LF	LH	WF	R	L	Screw	Wrench
SVJBR/L 1010JX-11F	10	10	10	120	-	10	●	●	SP025065	FT-TP08
SVJBR/L 1212JX-11F	12	12	12	120	-	12	●	●		
SVJBR/L 1616JX-11F	16	16	16	120	-	16	●	●		
SVJBR/L 2020JX-11F	20	20	20	120	20	20	●	●		

SVJB External Turning Shank - With Offset



Product code	Dimension (mm)						Stock		Spare parts	
	H	B	HF	LF	LH	WF	R	L	Screw	Wrench
SVJBR/L 2020K-11	20	20	20	125	30	25	●	●	SP025065	FT-TP08
SVJBR/L 2020K-16	20	20	20	125	30	25	●	●	SP040090-X	FT-TP15
SVJBR/L 2525M-16	25	25	25	150	30	32	●	●		

Applicable Insert

Applicaition	Finishing	Finishing	Finishing	Finishing	Semi-finishing--Finishing
Insert Shape	F	M	Y	LF	UF
Holder Type					
SVJBR/L....-11/11F	VBET 1103	VBET 1103	VBET 1103	VBGT 1103	VBGT 1103
SVJBR/L....-16	VBET 1604	VBET 1604	VBET 1604	VBGT 1604	VBGT 1604
Reference page	P87	P88	P88	P84	P84, 85

●: Stock available ▲: Stock available now but will be replaced in the future.

SVPB External Turning Shank - With Offset

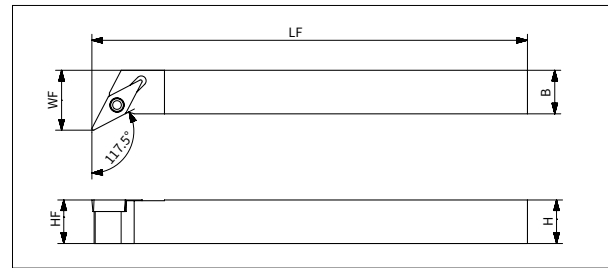

Product code	Dimension (mm)					Stock		Spare parts	
	H	B	HF	LF	WF	R	L	Screw	Wrench
SVPBR/L 1010JX-11	10	10	10	120	14.5	●	●	SP025065	FT-TP08
SVPBR/L 1212JX-11	12	12	12	120	16.5	●	●		
SVPBR/L 1616JX-11	16	16	16	120	20.5	●	●		
SVPBR/L 2020K-11	20	20	20	125	25	●	●		
SVPBR/L 2020K-16	20	20	20	125	25	●	●	SP040090-X	FT-TP15
SVPBR/L 2525M-16	25	25	25	150	32	●	●		

SVVBN External Turning Shank - Neutral

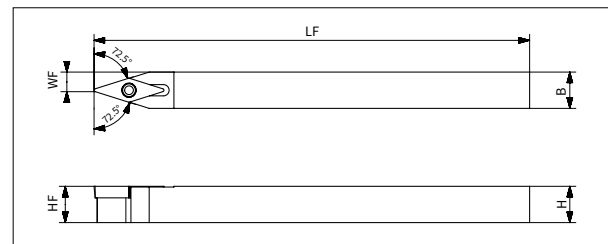

Product code	Dimension (mm)					Stock	Spare parts	
	H	B	HF	LF	WF	N	Screw	Wrench
SVVBN 1010JX-11	10	10	10	120	5	●	SP025065	FT-TP08
SVVBN 1212JX-11	12	12	12	120	6	●		
SVVBN 1616JX-11	16	16	16	120	8	●		
SVVBN 2020K-11	20	20	20	125	10	●		
SVVBN 2020K-16	20	20	20	125	10	●	SP040090-X	FT-TP15
SVVBN 2525M-16	25	25	25	150	12.5	●		

Applicable Insert

Applicaiton	Finishing	Finishing	Finishing	Finishing	Semi-finishing--Finishing
Insert Shape	F	M	Y	LF	UF
Holder Type					
SVPBR/L----11 SVVBN ----11	VBET 1103	VBET 1103	VBET 1103	VBGT 1103	VBGT 1103
SVPBR/L----16 SVVBN ----16	VBET 1604	VBET 1604	VBET 1604	VBGT 1604	VBGT 1604
Reference page	P87	P88	P88	P84	P84, 85

●: Stock available ▲: Stock available now but will be replaced in the future.

SVJCR External Turning Shank - Without Offset

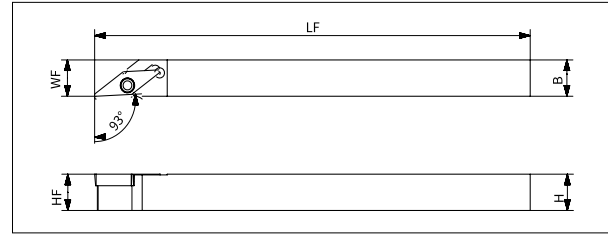

Product code	Dimension (mm)					Stock		Spare parts	
	H	B	HF	LF	WF	R	L	Screw	Wrench
SVJCR/L 1010JX-11F	10	10	10	120	10	●	●	SP025065	FT-TP08
SVJCR/L 1212JX-11F	12	12	12	120	12	●	●		
SVJCR/L 1616JX-11F	16	16	16	120	16	●	●		
SVJCR/L 2020JX-11F	20	20	20	120	20	●	●		

SVVCN External Turning Shank - Neutral

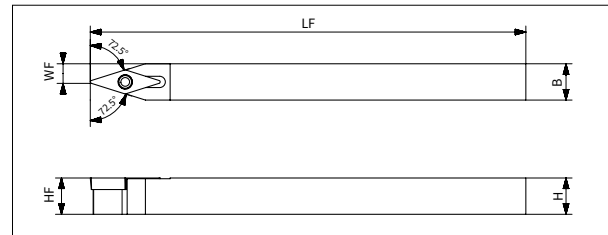

Product code	Dimension (mm)					Stock	Spare parts	
	H	B	HF	LF	WF	N	Screw	Wrench
SVVCN 1010JX-11	10	10	10	120	5	●	SP025065	FT-TP08
SVVCN 1212JX-11	12	12	12	120	6	●		
SVVCN 1616JX-11	16	16	16	120	8	●		

Applicable Insert

Applicaiton	Finishing	Finishing	Finishing
Insert Shape	F	LF	UF
			
Holder Type			
SVJCR/L....-11F SVVCN-11	VCET 1103	VCGT 1103	VCGT 1103
Reference page	P87	P84	P84、 85

●: Stock available ▲: Stock available now but will be replaced in the future.

SVLP External Turning Shank - Without Offset

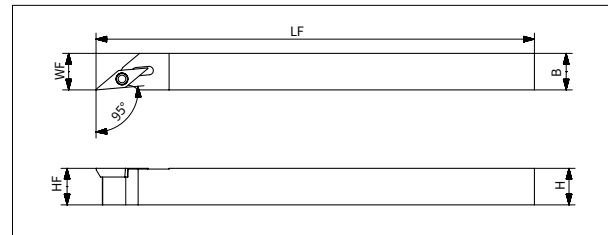

Product code	Dimension (mm)						Stock		Spare parts	
	H	B	HF	LF	LH	WF	R	L	Screw	Wrench
SVLPR/L 1010JX-08F	10	10	10	120	16	10	●	●	SP020049	FT-TP06
SVLPR/L 1212JX-08F	12	12	12	120	16	12	●	●		
SVLPR/L 1616JX-08F	16	16	16	120	20	16	●	●		
SVLPR/L 1212JX-11F	10	10	10	120	20	10	●	●	SP025065	FT-TP08
SVLPR/L 1616JX-11F	12	12	12	120	20	12	●	●		
SVLPR/L 2020K-11F	16	16	16	120	20	16	●	●		

SVPP External Turning Shank - Step Style

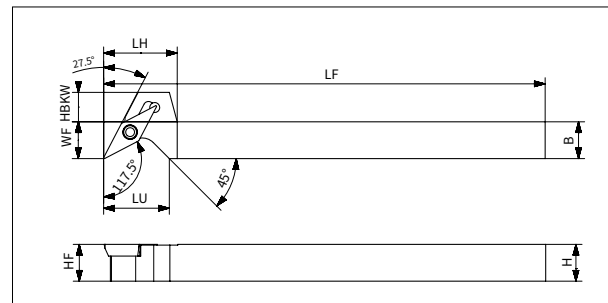

Product code	Dimension (mm)							Stock		Spare parts	
	H	B	HF	LF	LH	WF	HBKW	R	L	Screw	Wrench
SVPPR/L 1010JX-08F	10	10	10	120	16	10	4	●	●	SP020049	FT-TP06
SVPPR/L 1212JX-08F	12	12	12	120	16	12	2	●	●		
SVPPR/L 1616JX-08F	16	16	16	120	20	16	-	●	●		
SVPPR/L 1010JX-11F	10	10	10	120	20	10	8	●	●	SP025065	FT-TP08
SVPPR/L 1212JX-11F	12	12	12	120	20	12	6	●	●		
SVPPR/L 1616JX-11F	16	16	16	120	20	16	2	●	●		

Applicable Insert

Applicaition	Finishing	Finishing	Finishing	Semi-finishing–Finishing
Insert Shape	F	M	LF	UF
Holder Type				
SVLPR/L.....08F SVPPR/L.....08F	VPET 0802	VPET 0802	-	-
SVLPR/L.....11F SVPPR/L.....11F	-	VPET 1103	VPGT 1103	VPGT 1103
Reference page	P87	P88	P84	P84、85

● : Stock available ▲ : Stock available now but will be replaced in the future.

Small Tools

External Sleeve Holder Denomination System





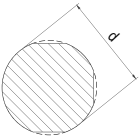

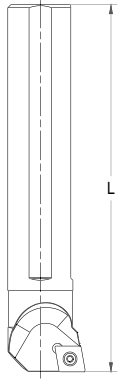

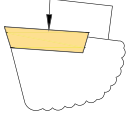
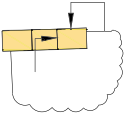
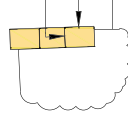
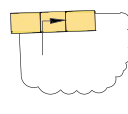
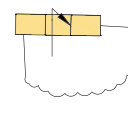

S	20	JX	S	C
1	2	3	4	5

1-Holder Structure	
A	Steel shank with internal coolant
C	Carbide
E	Carbide with internal coolant
S	Steel shank

2 - Holder Diameter (mm)		
	06 = 6	20 = 20
	08 = 8	25 = 25
	10 = 10	32 = 32
	12 = 12	40 = 40
	16 = 16	50 = 50

3-Holder Length (mm)		
	E=70	K=125
	F=80	L=140
	FX=85	M=150
	G=90	N=160
	H=100	P=170
	J=110	Q=180
	JX=120	R=200

4-Clamping Type				
C:Top clamp	M:Top wedge clamping	D:Rigid clamping	P:lever clamping	S:Screw clamping
				

5 - Insert Shape									
C	D	H	K	O	R	S	T	V	W
 80°	 55°	 120°	 55°	 135°	 360°	 90°	 60°	 35°	 80°

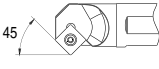
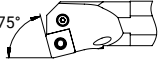
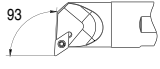
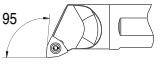
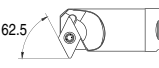
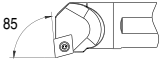
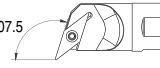
6- Approaching Angle							
F	 90°	S	 45°	K	 75°	U	 93°
L	 95°	W	 62.5°	Y	 85°	Q	 107.5°

L
6





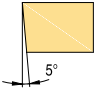
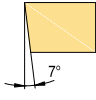
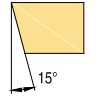
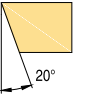
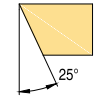
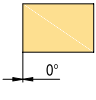
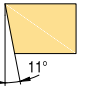

C
7

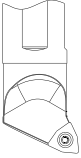
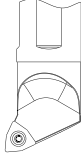
L
8

09
9

7 - Clearance Angle			
B	C	D	E
			
F	N	P	O
			Other clearance angle

8-Hand of Tool	
R Right hand	
L Left hand	

9 - Length of Cutting Edge			
C, D, E, M, V		H	O
			
R	S	T	W
			

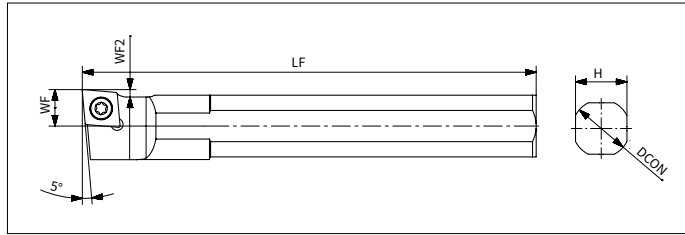

Small Tools

External Sleeve Holder - Suitable for C Type Insert

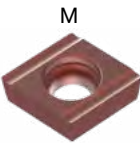

Product code	Dimension (mm)					Stock	Spare parts	
	DCON	LF	H	WF	WF2	L	Screw	Wrench
S12F-SCLCL06	12	80	11	6	1	●	SP025065	FT-TP08
S14H-SCLCL06	14	100	13	6	1	●		
S15.0H-SCLCL06	15.875	100	15	6	1	●		
S16H-SCLCL06	16	100	15	6	1	●		
S19.0JX-SCLCL06	19.05	120	17	6	1	●		
S20JX-SCLCL06	20	120	18	6	1	●	SP040090-X	FT-TP15
S19.0JX-SCLCL09	19.05	120	17	10	2	●		
S20JX-SCLCL09	20	120	18	10	2	●		
S22JX-SCLCL09	22	120	20	10	2	●		
S25JX-SCLCL09	25	120	23	10	2	●		
S25.0JX-SCLCL09	25.4	120	23	10	2	●		

Applicable Insert

Applicaiton	Finishing	Finishing	Finishing	Semi-finishing–Finishing
Insert Shape	F	M	LF	UF
Holder Type				
S-SCLC06	CCET 0602	CCET 0602	CCGT 0602	CCGT 0602
S-SCLC09	CCET 09T3	CCET 09T3	CCGT 09T3	CCGT 09T3
Reference page	P73	P73	P70	P70

●: Stock available ▲: Stock available now but will be replaced in the future.

External Sleeve Holder-Suitable for D Type Insert

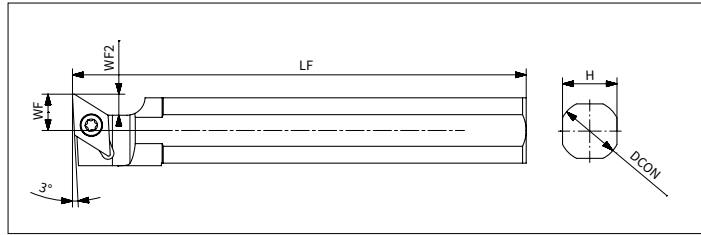

Product code	Dimension (mm)					Stock	Spare parts	
	DCON	LF	H	WF	WF2	L	Screw	Wrench
S12F-SDUCL07	12	80	11	6	3.8	●	SP025065	FT-TP08
S14H-SDUCL07	14	100	13	6	3.8	●		
S15.0H-SDUCL07	15.875	100	15	6	3.8	●		
S16H-SDUCL07	16	100	15	6	3.8	●		
S19.0JX-SDUCL07	19.05	120	17	6	3.8	●		
S20JX-SDUCL07	20	120	18	6	3.8	●		
S19.0JX-SDUCL11	19.05	120	17	10	5.8	●	SP040090-X	FT-TP15
S20JX-SDUCL11	20	120	20	10	5.8	●		
S22JX-SDUCL11	22	120	20	10	5.8	●		
S25JX-SDUCL11	25	120	23	10	5.8	●		
S25.0JX-SDUCL11	25.4	120	23	10	5.8	●		

Small Tools

Applicable Insert

Applicaiton	Finishing	Finishing	Finishing	Semi-finishing–Finishing
Insert Shape	F	M	LF	UF
Holder Type				
S-SDUCL07	DCET 0702	DCET 0702	DCGT 0702	DCGT 0702
S-SDUCL11	DCET 11T3	DCET 11T3	DCGT 11T3	DCGT 11T3
Reference page	P76	P77	P74	P74

●: Stock available ▲: Stock available now but will be replaced in the future.

External Sleeve Holder-Suitable for V Type Insert

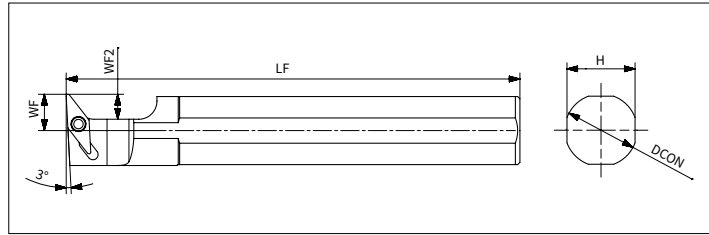

Product code	Dimension (mm)					Stock	Spare parts	
	DCON	LF	H	WF	WF2	L	Screw	Wrench
S12F-SVUPL08	12	80	11	7.5	5.5	●	SP020049	FT-TP06
S14H-SVUPL08	14	100	13	7.5	5.5	●		
S15.0H-SVUPL08	15.875	100	15	8	5.5	●		
S16H-SVUPL08	16	100	15	8	5.5	●		
S19.0JX-SVUBL11	19.05	120	17	10.5	8	●	SP025065	FT-TP08
S20JX-SVUBL11	20	120	18	10.5	8	●		
S22JX-SVUBL11	22	120	20	10.5	8	●		
S25JX-SVUBL11	25	120	23	10.5	8	●		
S25.0JX-SVUBL11	25.4	120	23	10.5	8	●		

Applicable Insert

Applicaiton	Finishing	Finishing	Finishing	Finishing	Semi-finishing--Finishing
Insert Shape Holder Type	F 	M 	Y 	LF 	UF
	S-SVUPL08	VPET 0802	VPET 0802	-	-
S-SVUBL11	VBET 1103	VBET 1103	VBET 1103	VBGT 1103	VBGT 1103
Reference page	P87	P88	P88	P84	P84、85

●: Stock available ▲: Stock available now but will be replaced in the future.

ABF Backturning Tool Hoder

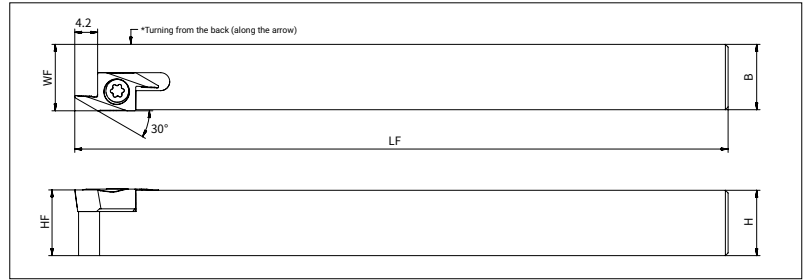

Product code	Dimension (mm)					Stock	Spare parts	
	H	B	HF	LF	WF		Screw	Wrench
ABFSR 1010-07	10	10	10	120	10.2	●		
ABFSR 1212-07	12	12	12	120	12.2	●	SP030082	FT-TP09
ABFSR 1616-07	16	16	16	120	16.2	●		

ABF Backturning Insert

Insert	Dimension (mm)	Product code	Dimension (mm)	Grade
			RE	AP301M
		ABF 07R280005-FR	0.05	●
		ABF 07R280010-FR	0.1	●
		ABF 07R280015-FR	0.15	●
		ABF 07R280020-FR	0.2	●

Small Tools

●: Stock available ▲: Stock available now but will be replaced in the future.

ASW Multifunctional Tool Holder

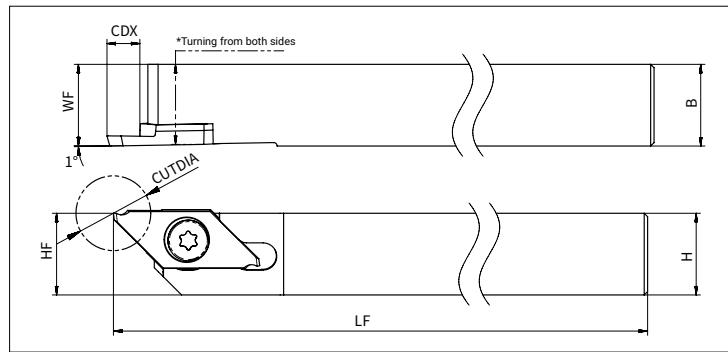

Product code	Dimension (mm)							Stock		Spare parts	
	H	HF	B	LF	LH	WF	CDX	R	L	Screw	Wrench
ASWSR/L 1010-09	10	10	10	120	15	10	6	●	●	SP04509357	FT-TP10
ASWSR/L 1212-09	12	12	12	120	-	12	6	●	●		
ASWSR/L 1616-09	16	16	16	120	-	16	6	●	●		
ASWSR/L 2020-09	20	20	20	120	-	20	6	●	●		
ASWSR/L 1010-10	10	10	10	120	20	10	8	●	●		
ASWSR/L 1212-10	12	12	12	120	-	12	8	●	●		
ASWSR/L 1616-10	16	16	16	120	-	16	8	●	●		
ASWSR/L 2020-10	20	20	20	120	-	20	8	●	●		

Applicable Insert

Applicaiton	Parting off	Backturning	Threading
Insert Shape			
Holder Type			
ASWSR/L....-09	ASWP 09R/L	ASWB 09R/L	ASWT 09R/L
ASWSR/L....-10	ASWP 10R/L	ASWB 10R/L	-
Reference page	P131、132	P133	P133

●: Stock available ▲: Stock available now but will be replaced in the future.

Parting off Insert

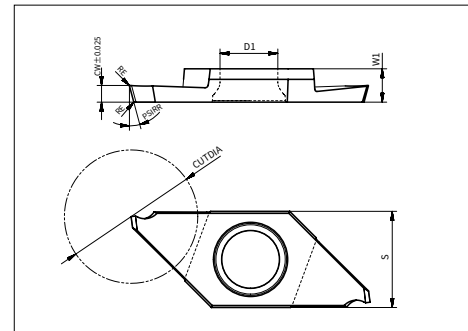

Product code	Dimension (mm)								Grade
	CW	CUTDIA	RE	PSIRR	GAN	W1	S	D1	AP301M
ASWP 09R/L050D05-F	0.5	5	0.03	0°	15°	3	8.7	5.2	●
ASWP 09R/L070D08-F	0.7	8	0.03	0°	15°	3	8.7	5.2	●
ASWP 09R/L100D12-F	1	12	0.03	0°	15°	3	8.7	5.2	●
ASWP 09R/L120D12-F	1.2	12	0.03	0°	15°	3	8.7	5.2	●
ASWP 09R/L150D12-F	1.5	12	0.03	0°	15°	3	8.7	5.2	●
ASWP 09R/L200D12-F	2	12	0.03	0°	15°	3	8.7	5.2	●
ASWP 09R/L050D05-F16R	0.5	5	0.03	16°	25°	3	8.7	5.2	●
ASWP 09R/L070D08-F16R	0.7	8	0.03	16°	25°	3	8.7	5.2	●
ASWP 09R/L100D12-F16R	1	12	0.03	16°	25°	3	8.7	5.2	●
ASWP 09R/L120D12-F16R	1.2	12	0.03	16°	25°	3	8.7	5.2	●
ASWP 09R/L150D12-F16R	1.5	12	0.03	16°	15°	3	8.7	5.2	●
ASWP 09R/L200D12-F16R	2	12	0.03	16°	15°	3	8.7	5.2	●
ASWP 09R/L100D12-M	1	12	0.08	0°	12°	3	8.7	5.2	●
ASWP 09R/L150D12-M	1.5	12	0.08	0°	12°	3	8.7	5.2	●
ASWP 09R/L200D12-M	2	12	0.08	0°	12°	3	8.7	5.2	●
ASWP 09R/L100D12-M16R	1	12	0.08	16°	12°	3	8.7	5.2	●
ASWP 09R/L150D12-M16R	1.5	12	0.08	16°	12°	3	8.7	5.2	●
ASWP 09R/L200D12-M16R	2	12	0.08	16°	12°	3	8.7	5.2	●

Parting off Insert

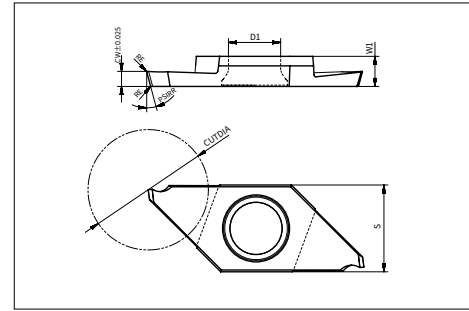

Product code	Dimension (mm)								Grade
	CW	CUTDIA	RE	PSIRR	GAN	W1	S	D1	AP301M
ASWP 09R/L050D05-T	0.5	5	0	0°	0°	3	8.7	5.2	●
ASWP 09R/L070D08-T	0.7	8	0	0°	0°	3	8.7	5.2	●
ASWP 09R/L100D12-T	1	12	0	0°	0°	3	8.7	5.2	●
ASWP 09R/L120D12-T	1.2	12	0	0°	0°	3	8.7	5.2	●
ASWP 09R/L150D12-T	1.5	12	0	0°	0°	3	8.7	5.2	●
ASWP 09R/L200D12-T	2	12	0	0°	0°	3	8.7	5.2	●
ASWP 09R/L050D05-T20R	0.5	5	0	20°	0°	3	8.7	5.2	●
ASWP 09R/L070D08-T20R	0.7	8	0	20°	0°	3	8.7	5.2	●
ASWP 09R/L100D12-T20R	1	12	0	20°	0°	3	8.7	5.2	●
ASWP 09R/L120D12-T20R	1.2	12	0	20°	0°	3	8.7	5.2	●
ASWP 09R/L150D12-T20R	1.5	12	0	20°	0°	3	8.7	5.2	●
ASWP 09R/L200D12-T20R	2	12	0	20°	0°	3	8.7	5.2	●
ASWP 10R/L150D16-F	1.5	16	0.05	0°	20°	4	9.5	5.2	●
ASWP 10R/L200D16-F	2	16	0.05	0°	20°	4	9.5	5.2	●
ASWP 10R/L150D16-F16R	1.5	16	0.05	16°	20°	4	9.5	5.2	●
ASWP 10R/L200D16-F16R	2	16	0.05	16°	20°	4	9.5	5.2	●
ASWP 10R/L150D16-M	1.5	16	0.08	0°	12°	4	9.5	5.2	●
ASWP 10R/L200D16-M	2	16	0.08	0°	12°	4	9.5	5.2	●
ASWP 10R/L150D16-M16R	1.5	16	0.08	16°	12°	4	9.5	5.2	●
ASWP 10R/L200D16-M16R	2	16	0.08	16°	12°	4	9.5	5.2	●
ASWP 10R/L150D16-T	1.5	16	0	0°	0°	4	9.5	5.2	●
ASWP 10R/L200D16-T	2	16	0	0°	0°	4	9.5	5.2	●
ASWP 10R/L150D16-T20R	1.5	16	0	20°	0°	4	9.5	5.2	●
ASWP 10R/L200D16-T20R	2	16	0	20°	0°	4	9.5	5.2	●

●: Stock available ▲: Stock available now but will be replaced in the future.

Backturning Insert

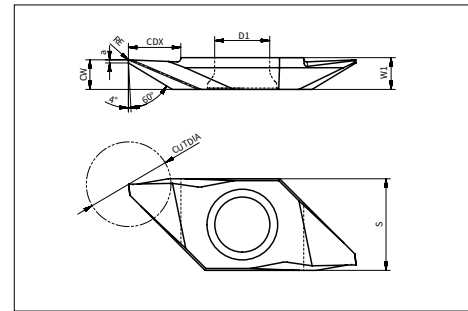

Product code	Dimension (mm)							Grade
	CW	a	CDX	W1	S	D1	RE	AP301M
ASWB 09R150005-FR	1.5	0.25	2.6	3	8.7	5.2	0.05	●
ASWB 09R280005-FR	2.8	0.3	4.6	3	8.7	5.2	0.05	●
ASWB 09L280005-FR	2.8	0.3	4.6	3	8.7	5.2	0.05	●
ASWB 09R280010-FR	2.8	0.3	4.6	3	8.7	5.2	0.1	●
ASWB 09L280010-FR	2.8	0.3	4.6	3	8.7	5.2	0.1	●
ASWB 10R380005-FR	3.8	0.3	6.3	4	9.5	5.2	0.05	●
ASWB 10L380005-FR	3.8	0.3	6.3	4	9.5	5.2	0.05	●
ASWB 10R380010-FR	3.8	0.3	6.3	4	9.5	5.2	0.1	●
ASWB 10L380010-FR	3.8	0.3	6.3	4	9.5	5.2	0.1	●

Threading Insert

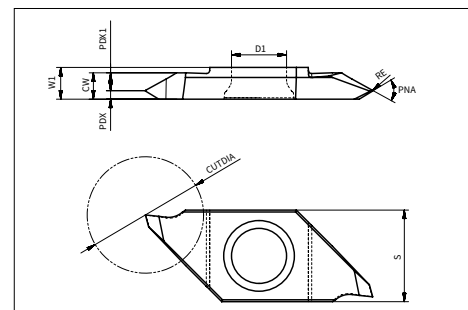

Product code	Angle	Applicable Thread		Dimension (mm)						Grade
	PNA	mm	Thread/Inch	PDX	RE	CW	W1	S	D1	AP301M
ASWT 09R60000-FR	60	0.2~0.6	64~48	0.4	0.05	2.5	3	8.7	5.2	●
ASWT 09R60000-FL	60	0.2~0.6	64~48	2.1	0.05	2.5	3	8.7	5.2	●
ASWT 09R60005-FR	60	0.5~1.25	48~24	0.8	0.05	2.5	3	8.7	5.2	●
ASWT 09R60005-FL	60	0.5~1.25	48~24	1.7	0.05	2.5	3	8.7	5.2	●
ASWT 09R60010-FN	60	1.0~1.5	24~18	1.25	0.1	2.5	3	8.7	5.2	●
ASWT 09R55005-FR	55	-	40~16	0.8	0.05	2.5	3	8.7	5.2	●
ASWT 09R55005-FL	55	-	40~16	1.7	0.05	2.5	3	8.7	5.2	●
ASWT 09L60000-FR	60	0.2~0.6	64~48	2.1	0.05	2.5	3	8.7	5.2	●
ASWT 09L60000-FL	60	0.2~0.6	64~48	0.4	0.05	2.5	3	8.7	5.2	●

●: Stock available ▲: Stock available now but will be replaced in the future.

Solid carbide boring tool holder

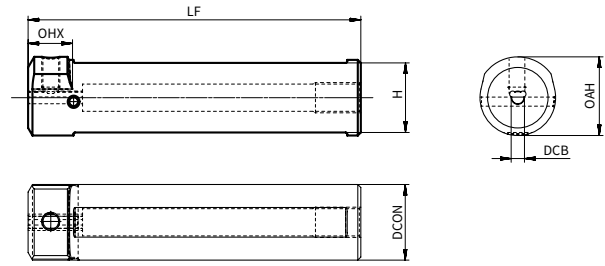

Product code	DCB	DCON	LF	H	Stock
ASI 0010-04	4	10	65	8	●
ASI 0010-05	5				●
ASI 0012-04	4	12	70	10	●
ASI 0012-05	5				●
ASI 0012-06	6				●
ASI 0016-04	4	16	75	14	●
ASI 0016-05	5				●
ASI 0016-06	6				●
ASI 0016-08	8				●
ASI 0020-04	4	20	90	18	●
ASI 0020-05	5				●
ASI 0020-06	6				●
ASI 0020-08	8				●
ASI 0025-04	4	25	110	23	●
ASI 0025-05	5				●
ASI 0025-06	6				●
ASI 0025-08	8				●

●: Stock available ▲: Stock available now but will be replaced in the future.

ASIB T Type-Small Dia. Boring Tool

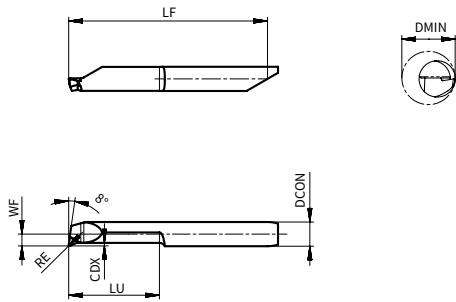

Product code	Dimension (mm)							AP220U	
	DCON	RE	WF	LF	DMIN	LU	CDX	R	L
ASIBR/L 04T000-0301	4	0	0.1	27.3	0.3	1.2	0.1	●	●
ASIBR/L 04T000-0401	4	0	0.2	27.3	0.4	1.6	0.1	●	●
ASIBR/L 04T000-0502	4	0	0.2	27.3	0.5	2	0.1	●	●
ASIBR/L 04T000-0602	4	0	0.3	27.3	0.6	2.5	0.1	●	●
ASIBR/L 04T000-0703	4	0	0.3	27.3	0.7	3.5	0.1	●	●
ASIBR/L 04T000-0804	4	0	0.4	27.3	0.8	4	0.1	●	●
ASIBR/L 04T000-0905	4	0	0.4	27.3	0.9	5	0.1	●	●
ASIBR/L 04T005-1004	4	0.05	0.5	27.3	1	4	0.1	●	●
ASIBR/L 04T005-1006	4	0.05	0.5	27.3	1	6	0.1	●	●
ASIBR/L 04T010-1004	4	0.1	0.5	27.3	1	4	0.1	●	●
ASIBR/L 04T010-1006	4	0.1	0.5	27.3	1	6	0.1	●	●
ASIBR/L 04T005-1706	4	0.05	0.7	27.3	1.7	6	0.2	●	●
ASIBR/L 04T005-1709	4	0.05	0.7	27.3	1.7	9	0.2	●	●
ASIBR/L 04T010-1706	4	0.1	0.7	27.3	1.7	6	0.2	●	●
ASIBR/L 04T010-1709	4	0.1	0.7	27.3	1.7	9	0.2	●	●
ASIBR/L 04T005-2206	4	0.05	1	27.3	2.2	6	0.2	●	●
ASIBR/L 04T005-2209	4	0.05	1	27.3	2.2	9	0.2	●	●
ASIBR/L 04T010-2206	4	0.1	1	27.3	2.2	6	0.2	●	●
ASIBR/L 04T010-2209	4	0.1	1	27.3	2.2	9	0.2	●	●
ASIBR/L 04T010-2213	4	0.1	1	32.3	2.2	13	0.2	●	●
ASIBR/L 04T003-2710	4	0.03	1.2	27.3	2.7	10	0.2	●	●
ASIBR/L 04T005-2710	4	0.05	1.2	27.3	2.7	10	0.2	●	●
ASIBR/L 04T005-2715	4	0.05	1.2	32.3	2.7	15	0.2	●	●
ASIBR/L 04T015-2710	4	0.15	1.2	27.3	2.7	10	0.2	●	●
ASIBR/L 04T015-2715	4	0.15	1.2	32.3	2.7	15	0.2	●	●
ASIBR/L 04T003-3210	4	0.03	1.5	27.3	3.2	10	0.2	●	●
ASIBR/L 04T005-3215	4	0.05	1.5	32.3	3.2	15	0.2	●	●
ASIBR/L 04T005-3220	4	0.05	1.5	37.3	3.2	20	0.2	●	●
ASIBR/L 04T015-3210	4	0.15	1.5	27.3	3.2	10	0.2	●	●
ASIBR/L 04T015-3215	4	0.15	1.5	32.3	3.2	15	0.2	●	●
ASIBR/L 04T015-3220	4	0.15	1.5	37.3	3.2	20	0.2	●	●
ASIBR/L 04T003-4210	4	0.03	2	27.3	4.2	10	0.3	●	●
ASIBR/L 04T005-4215	4	0.05	2	32.3	4.2	15	0.3	●	●
ASIBR/L 04T005-4220	4	0.05	2	37.3	4.2	20	0.3	●	●
ASIBR/L 04T005-4225	4	0.05	2	42.3	4.2	25	0.3	●	●
ASIBR/L 04T015-4210	4	0.15	2	27.3	4.2	10	0.3	●	●

●: Stock available ▲: Stock available now but will be replaced in the future.

Small Tools

ASIB T Type-Small Dia. Boring Tool

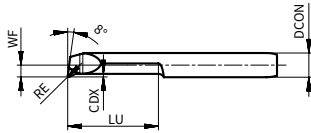
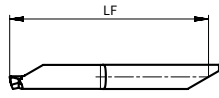

Product code	Dimension (mm)							AP220U	
	DCON	RE	WF	LF	DMIN	LU	CDX	R	L
ASIBR/L 04T015-4215	4	0.15	2	32.3	4.2	15	0.3	●	●
ASIBR/L 04T015-4220	4	0.15	2	37.3	4.2	20	0.3	●	●
ASIBR/L 04T015-4225	4	0.15	2	42.3	4.2	25	0.3	●	●
ASIBR/L 05T005-5220	5	0.05	2.5	42.3	5.2	20	0.5	●	●
ASIBR/L 05T005-5230	5	0.05	2.5	52.3	5.2	30	0.5	●	●
ASIBR/L 05T020-5210	5	0.2	2.5	32.3	5.2	10	0.5	●	●
ASIBR/L 05T020-5220	5	0.2	2.5	42.3	5.2	20	0.5	●	●
ASIBR/L 05T020-5225	5	0.2	2.5	47.3	5.2	25	0.5	●	●
ASIBR/L 05T020-5230	5	0.2	2.5	52.3	5.2	30	0.5	●	●
ASIBR/L 05T020-5235	5	0.2	2.5	57.3	5.2	35	0.5	●	●
ASIBR/L 05T020-5240	5	0.2	2.5	62.3	5.2	40	0.5	●	●
ASIBR/L 06T005-6220	6	0.05	3	42.3	6.2	20	0.5	●	●
ASIBR/L 06T020-6215	6	0.2	3	37.3	6.2	15	0.5	●	●
ASIBR/L 06T020-6220	6	0.2	3	42.3	6.2	20	0.5	●	●
ASIBR/L 06T020-6225	6	0.2	3	47.3	6.2	25	0.5	●	●
ASIBR/L 06T020-6230	6	0.2	3	52.3	6.2	30	0.5	●	●
ASIBR/L 06T020-6235	6	0.2	3	57.3	6.2	35	0.5	●	●
ASIBR/L 06T020-6240	6	0.2	3	62.3	6.2	40	0.5	●	●

●: Stock available ▲: Stock available now but will be replaced in the future.

ASIB E Type-Small Dia. Boring Tool

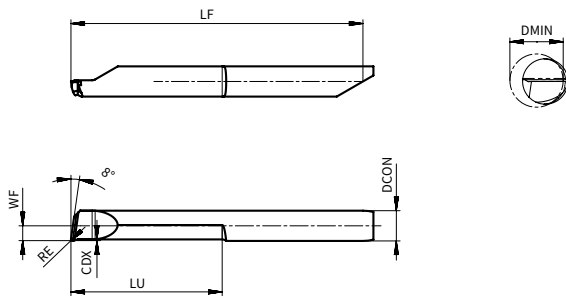

Product code	Dimension (mm)							AP220U	
	DCON	RE	WF	LF	DMIN	LU	CDX	R	L
ASIBR 04E008-4230	4	0.08	2	52.3	4.2	30	0.5	●	-
ASIBR/L 04E015-4210	4	0.15	2	27.3	4.2	10.3	0.5	●	●
ASIBR/L 04E015-4220	4	0.15	2	37.3	4.2	20.3	0.5	●	●
ASIBR/L 04E015-4225	4	0.15	2	42.3	4.2	25.3	0.5	●	●
ASIBR/L 04E020-4215	4	0.2	2	32.3	4.2	15.3	0.3	●	●
ASIBR 05E008-5240	5	0.08	2.5	67.3	5.2	40	0.5	●	-
ASIBR/L 05E020-5210	5	0.2	2.5	32.3	5.2	10.2	0.6	●	●
ASIBR/L 05E020-5215	5	0.2	2.5	37.3	5.2	15	0.5	●	●
ASIBR/L 05E020-5220	5	0.2	2.5	42.3	5.2	20.3	0.6	●	●
ASIBR/L 05E020-5225	5	0.2	2.5	47.3	5.2	25.4	0.5	●	●
ASIBR/L 05E020-5230	5	0.2	2.5	52.3	5.2	30.5	0.6	●	●
ASIBR 06E008-6245	6	0.08	3	72.3	6.2	45	0.5	●	-
ASIBR/L 06E020-6215	6	0.2	3	37.3	6.2	15.2	0.8	●	●
ASIBR/L 06E020-6220	6	0.2	3	42.3	6.2	20.3	0.8	●	●
ASIBR/L 06E020-6225	6	0.2	3	47.3	6.2	25.4	0.8	●	●
ASIBR/L 06E020-6230	6	0.2	3	52.3	6.2	30.5	0.5	●	●
ASIBR/L 06E020-6240	6	0.2	3	62.3	6.2	40	0.5	●	●

ASIB S Type-Small Dia. Boring Tool

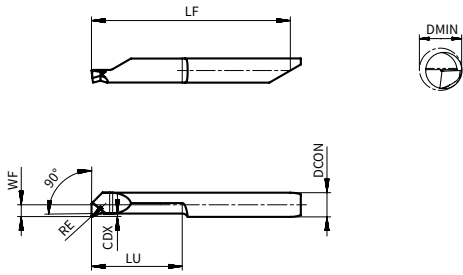

Product code	Dimension (mm)							AP220U	
	DCON	RE	WF	LF	DMIN	LU	CDX	R	L
ASIBR/L 04S015-3212	4	0.15	1.5	29.3	3.2	12	0.2	●	●
ASIBR/L 04S015-4215	4	0.15	2	32.3	4.2	15	0.3	●	●
ASIBR/L 05S020-5210	5	0.2	2.5	32.3	5.2	10	0.5	●	●
ASIBR/L 05S020-5215	5	0.2	2.5	37.3	5.2	15	0.5	●	●
ASIBR/L 05S020-5220	5	0.2	2.5	42.3	5.2	20	0.5	●	●

ASIB V Type-Small Dia. Boring Tool

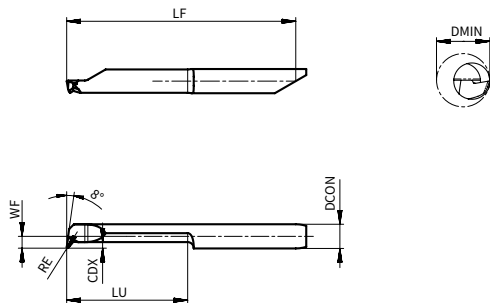

Product code	Dimension (mm)							AP220U	
	DCON	RE	WF	LF	DMIN	LU	CDX	R	L
ASIBR/L 04V015-4220	4	0.15	2	37.3	4.2	20	0.8	●	●
ASIBR/L 05V015-5225	5	0.15	2.5	47.3	5.2	25	1	●	●
ASIBR/L 06V015-6230	6	0.15	3	52.3	6.2	30	1.8	●	●

●: Stock available ▲: Stock available now but will be replaced in the future.

ASIG S Type-Small Dia. Internal Grooving Tool

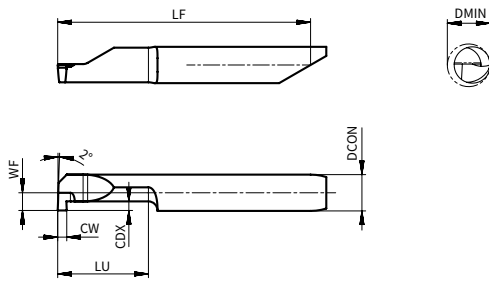

Product code	Dimension (mm)							AP220U	
	DCON	CW	WF	LF	DMIN	LU	CDX	R	L
ASIGR/L 04S050-2006	4	0.5	2	23.3	2	6	0.4	●	●
ASIGR/L 04S050-2009	4	0.5	2	26.3	2	9	0.4	●	●
ASIGR/L 04S050-2012	4	0.5	2	29.3	2	12	0.4	●	●
ASIGR/L 04S070-3008	4	0.7	1.4	25.3	3	8	0.6	●	●
ASIGR/L 04S070-3012	4	0.7	1.4	29.3	3	12	0.6	●	●
ASIGR/L 04S070-3016	4	0.7	1.4	33.3	3	16	0.6	●	●
ASIGR/L 04S100-4210	4	1	2	27.3	4.2	10	0.8	●	●
ASIGR/L 04S100-4215	4	1	2	32.3	4.2	15	0.8	●	●
ASIGR/L 04S100-4220	4	1	2	37.3	4.2	20	0.8	●	●
ASIGR/L 05S100-5210	5	1	2.5	32.3	5.2	10	1	●	●
ASIGR/L 05S100-5215	5	1	2.5	37.3	5.2	15	1	●	●
ASIGR/L 05S100-5220	5	1	2.5	42.3	5.2	20	1	●	●
ASIGR/L 05S100-5225	5	1	2.5	47.3	5.2	25	1	●	●
ASIGR/L 05S100-5230	5	1	2.5	52.3	5.2	30	1	●	●
ASIGR/L 05S100-5235	5	1	2.5	57.3	5.2	35	1	●	●
ASIGR/L 05S150-5210	5	1.5	2.5	32.3	5.2	10	1	●	●
ASIGR/L 05S150-5215	5	1.5	2.5	37.3	5.2	15	1	●	●
ASIGR/L 05S150-5220	5	1.5	2.5	42.3	5.2	20	1	●	●
ASIGR/L 05S150-5225	5	1.5	2.5	47.3	5.2	25	1	●	●
ASIGR/L 05S150-5230	5	1.5	2.5	52.3	5.2	30	1	●	●
ASIGR/L 05S150-5235	5	1.5	2.5	57.3	5.2	35	1	●	●
ASIGR/L 05S200-5210	5	2	2.5	32.3	5.2	10	1	●	●
ASIGR/L 05S200-5215	5	2	2.5	37.3	5.2	15	1	●	●
ASIGR/L 05S200-5220	5	2	2.5	42.3	5.2	20	1	●	●
ASIGR/L 05S200-5225	5	2	2.5	47.3	5.2	25	1	●	●
ASIGR/L 05S200-5230	5	2	2.5	52.3	5.2	30	1	●	●
ASIGR/L 06S100-6210	6	1	3	32.3	6.2	10	1.8	●	●
ASIGR/L 06S100-6215	6	1	3	37.3	6.2	15	1.8	●	●
ASIGR/L 06S100-6220	6	1	3	42.3	6.2	20	1.8	●	●
ASIGR/L 06S100-6225	6	1	3	47.3	6.2	25	1.8	●	●
ASIGR/L 06S100-6230	6	1	3	52.3	6.2	30	1.8	●	●
ASIGR/L 06S100-6235	6	1	3	57.3	6.2	35	1.8	●	●
ASIGR/L 06S100-6240	6	1	3	62.3	6.2	40	1.8	●	●
ASIGR/L 06S150-6210	6	1.5	3	32.3	6.2	10	1.8	●	●
ASIGR/L 06S150-6215	6	1.5	3	37.3	6.2	15	1.8	●	●
ASIGR/L 06S150-6220	6	1.5	3	42.3	6.2	20	1.8	●	●

●: Stock available ▲: Stock available now but will be replaced in the future.

Small Tools

ASIG S Type-Small Dia. Internal Grooving Tool

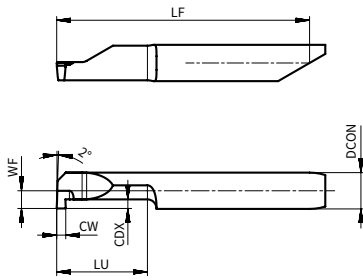

Product code	Dimension (mm)							AP220U	
	DCON	CW	WF	LF	DMIN	LU	CDX	R	L
ASIGR/L 06S150-6225	6	1.5	3	47.3	6.2	25	1.8	●	●
ASIGR/L 06S150-6230	6	1.5	3	52.3	6.2	30	1.8	●	●
ASIGR/L 06S150-6235	6	1.5	3	57.3	6.2	35	1.8	●	●
ASIGR/L 06S200-6210	6	2	3	32.3	6.2	10	1.8	●	●
ASIGR/L 06S200-6215	6	2	3	37.3	6.2	15	1.8	●	●
ASIGR/L 06S200-6220	6	2	3	42.3	6.2	20	1.8	●	●
ASIGR/L 06S200-6225	6	2	3	47.3	6.2	25	1.8	●	●
ASIGR/L 06S200-6230	6	2	3	52.3	6.2	30	1.8	●	●

●: Stock available ▲: Stock available now but will be replaced in the future.

ASIG S Type-Small Dia. Internal Grooving Tool (For Circlip Groove)

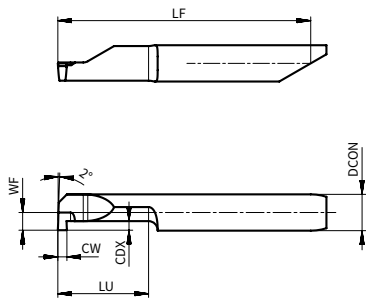

Product code	Dimension (mm)							AP220U	
	DCON	CW	WF	LF	DMIN	LU	CDX	R	L
ASIGR/L 04S078-4210	4	0.78	2	27.3	4.2	10	0.8	●	●
ASIGR/L 04S078-4215	4	0.78	2	32.3	4.2	15	0.8	●	●
ASIGR/L 04S078-4220	4	0.78	2	37.3	4.2	20	0.8	●	●
ASIGR/L 04S078-4225	4	0.78	2	42.3	4.2	25	0.8	●	●
ASIGR/L 05S078-5210	5	0.78	2.5	32.3	5.2	10	1	●	●
ASIGR/L 05S078-5215	5	0.78	2.5	37.3	5.2	15	1	●	●
ASIGR/L 05S078-5220	5	0.78	2.5	42.3	5.2	20	1	●	●
ASIGR/L 05S078-5225	5	0.78	2.5	47.3	5.2	25	1	●	●
ASIGR/L 05S078-5230	5	0.78	2.5	52.3	5.2	30	1	●	●
ASIGR/L 05S078-5235	5	0.78	2.5	57.3	5.2	35	1	●	●
ASIGR/L 05S117-5210	5	1.17	2.5	32.3	5.2	10	1	●	●
ASIGR/L 05S117-5215	5	1.17	2.5	37.3	5.2	15	1	●	●
ASIGR/L 05S117-5220	5	1.17	2.5	42.3	5.2	20	1	●	●
ASIGR/L 05S117-5225	5	1.17	2.5	47.3	5.2	25	1	●	●
ASIGR/L 05S117-5230	5	1.17	2.5	52.3	5.2	30	1	●	●
ASIGR/L 05S117-5235	5	1.17	2.5	57.3	5.2	35	1	●	●
ASIGR/L 05S157-5210	5	1.57	2.5	32.3	5.2	10	1	●	●
ASIGR/L 05S157-5215	5	1.57	2.5	37.3	5.2	15	1	●	●
ASIGR/L 05S157-5220	5	1.57	2.5	42.3	5.2	20	1	●	●
ASIGR/L 05S157-5225	5	1.57	2.5	47.3	5.2	25	1	●	●
ASIGR/L 05S157-5230	5	1.57	2.5	52.3	5.2	30	1	●	●
ASIGR/L 05S198-5210	5	1.98	2.5	32.3	5.2	10	1	●	●
ASIGR/L 05S198-5215	5	1.98	2.5	37.3	5.2	15	1	●	●
ASIGR/L 05S198-5220	5	1.98	2.5	42.3	5.2	20	1	●	●
ASIGR/L 05S198-5225	5	1.98	2.5	47.3	5.2	25	1	●	●
ASIGR/L 05S198-5230	5	1.98	2.5	52.3	5.2	30	1	●	●
ASIGR/L 06S078-6210	6	0.78	3	32.3	6.2	10	1.8	●	●
ASIGR/L 06S078-6215	6	0.78	3	37.3	6.2	15	1.8	●	●
ASIGR/L 06S078-6220	6	0.78	3	42.3	6.2	20	1.8	●	●
ASIGR/L 06S078-6225	6	0.78	3	47.3	6.2	25	1.8	●	●
ASIGR/L 06S078-6230	6	0.78	3	52.3	6.2	30	1.8	●	●
ASIGR/L 06S078-6235	6	0.78	3	57.3	6.2	35	1.8	●	●
ASIGR/L 06S117-6210	6	1.17	3	32.3	6.2	10	1.8	●	●
ASIGR/L 06S117-6215	6	1.17	3	37.3	6.2	15	1.8	●	●
ASIGR/L 06S117-6220	6	1.17	3	42.3	6.2	20	1.8	●	●
ASIGR/L 06S117-6225	6	1.17	3	47.3	6.2	25	1.8	●	●

● : Stock available ▲ : Stock available now but will be replaced in the future.

Small Tools

ASIG S Type-Small Dia. Internal Grooving Tool (For Circlip Groove)

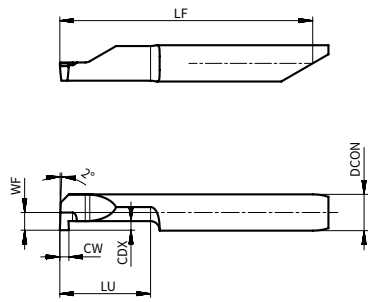

Product code	Dimension (mm)							AP220U	
	DCON	CW	WF	LF	DMIN	LU	CDX	R	L
ASIGR/L 06S117-6230	6	1.17	3	52.3	6.2	30	1.8	●	●
ASIGR/L 06S117-6235	6	1.17	3	57.3	6.2	35	1.8	●	●
ASIGR/L 06S117-6240	6	1.17	3	62.3	6.2	40	1.8	●	●
ASIGR/L 06S157-6210	6	1.57	3	32.3	6.2	10	1.8	●	●
ASIGR/L 06S157-6215	6	1.57	3	37.3	6.2	15	1.8	●	●
ASIGR/L 06S157-6220	6	1.57	3	42.3	6.2	20	1.8	●	●
ASIGR/L 06S157-6225	6	1.57	3	47.3	6.2	25	1.8	●	●
ASIGR/L 06S157-6230	6	1.57	3	52.3	6.2	30	1.8	●	●
ASIGR/L 06S157-6235	6	1.57	3	57.3	6.2	35	1.8	●	●
ASIGR/L 06S157-6240	6	1.57	3	62.3	6.2	40	1.8	●	●
ASIGR/L 06S198-6210	6	1.98	3	32.3	6.2	10	1.8	●	●
ASIGR/L 06S198-6215	6	1.98	3	37.3	6.2	15	1.8	●	●
ASIGR/L 06S198-6225	6	1.98	3	47.3	6.2	25	1.8	●	●
ASIGR/L 06S198-6235	6	1.98	3	57.3	6.2	35	1.8	●	●

●: Stock available ▲: Stock available now but will be replaced in the future.

ASIG R Type-Small Dia. Internal Grooving Tool

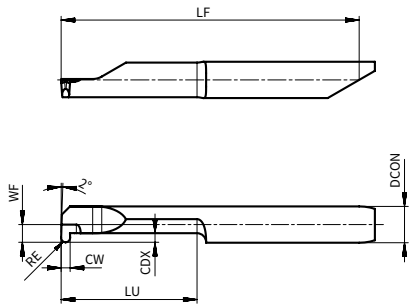

Product code	Dimension (mm)							AP220U	
	DCON	CW	WF	LF	DMIN	LU	CDX	R	L
ASIGR/L 04R100-4215	4	1	2	32.3	4.2	15	0.8	●	●
ASIGR/L 05R100-5220	5	1	2.5	42.3	5.2	20	1	●	●
ASIGR/L 05R150-5220	5	1.5	2.5	42.3	5.2	20	1	●	●
ASIGR/L 05R200-5220	5	2	2.5	42.3	5.2	20	1	●	●
ASIGR/L 06R100-6225	6	1	3	47.3	6.2	25	1.8	●	●
ASIGR/L 06R150-6225	6	1.5	3	47.3	6.2	25	1.8	●	●
ASIGR/L 06R200-6225	6	2	3	47.3	6.2	25	1.8	●	●

Small Tools

ASIG R Type-Small Dia. Internal Grooving Tool (For Circlip Groove)

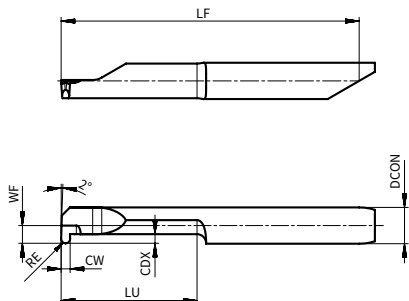

Product code	Dimension (mm)							AP220U	
	DCON	CW	WF	LF	DMIN	LU	CDX	R	L
ASIGR/L 04R117-4215	4	1.17	2	32.3	4.2	15	0.8	●	●
ASIGR/L 05R117-5220	5	1.17	2.5	42.3	5.2	20	1	●	●
ASIGR/L 05R163-5220	5	1.63	2.5	42.3	5.2	20	1	●	●
ASIGR/L 05R198-5220	5	1.98	2.5	42.3	5.2	20	1	●	●
ASIGR/L 06R117-6225	6	1.17	3	47.3	6.2	25	1.8	●	●
ASIGR/L 06R163-6225	6	1.63	3	47.3	6.2	25	1.8	●	●
ASIGR/L 06R198-6225	6	1.98	3	47.3	6.2	25	1.8	●	●

●: Stock available ▲: Stock available now but will be replaced in the future.

ASIF A Type - Small Dia. Internal Face Grooving (Inward Deviation)

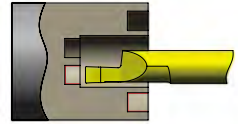
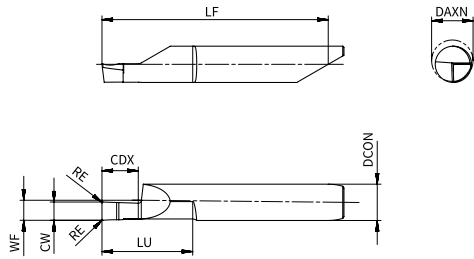

Product code	Dimension (mm)								AP220U	
	DCON	CW	WF	RE	LF	DAXN	LU	CDX	R	L
ASIFR/L 06A100-6215	6	1	3	0.15	37.3	6.2	15	2	●	●
ASIFR/L 06A150-6215	6	1.5	3	0.15	37.3	6.2	15	3	●	●
ASIFR/L 06A200-6215	6	2	3	0.15	37.3	6.2	15	4	●	●
ASIFR/L 06A250-6215	6	2.5	3	0.15	37.3	6.2	15	5	●	●
ASIFR/L 06A300-6215	6	3	3	0.15	37.3	6.2	15	6	●	●
ASIFR/L 08A200-8015	8	2	3	0.2	44.3	8	15	15	●	●
ASIFR/L 08A250-8010	8	2.5	3	0.2	39.3	8	10	10	●	●
ASIFR/L 08A300-8010	8	3	3	0.2	39.3	8	10	10	●	●
ASIFR/L 08A300-8015	8	3	3	0.2	44.3	8	15	15	●	●
ASIFR/L 08A400-8010	8	4	3	0.2	39.3	8	10	10	●	●
ASIFR/L 08A400-8015	8	4	3	0.2	44.3	8	15	15	●	●

ASIF B Type - Small Dia. Internal Face Grooving (Outward Deviation)

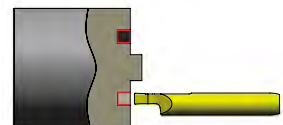
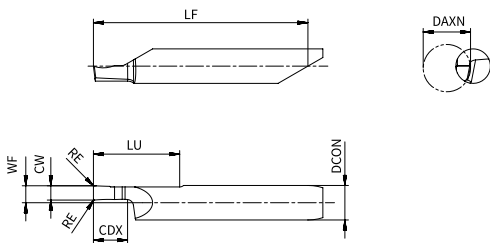

Product code	Dimension (mm)								AP220U	
	DCON	CW	WF	RE	LF	DAXN	LU	CDX	R	L
ASIFR/L 06B100-6215	6	1	3	0.15	37.3	6.2	15	2	●	●
ASIFR/L 06B150-6215	6	1.5	3	0.15	37.3	6.2	15	3	●	●
ASIFR/L 06B200-6215	6	2	3	0.15	37.3	6.2	15	4	●	●
ASIFR/L 06B250-6215	6	2.5	3	0.15	37.3	6.2	15	5	●	●
ASIFR/L 06B300-6215	6	3	3	0.15	37.3	6.2	15	6	●	●

●: Stock available ▲: Stock available now but will be replaced in the future.

ASIT V Type - Small Dia. Internal 60° Partial Profile Threading Tool

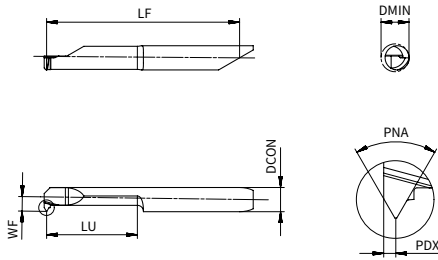

Product code	Dimension (mm)								AP220U	
	DCON	PDX	PNA	WF	LF	P	DMIN	LU	R	L
ASITR/L 04V050-4215	4	0.4	60°	2	32.7	0.5~0.7	4.2	15	●	●
ASITR 05V050-5215	5	0.4	60°	2.5	37.7	0.5~0.75	5.2	15	●	-
ASITR 05V070-5115	5	0.5	60°	2.4	37.8	0.7~1	5.1	15	●	-
ASITR/L 05V100-4815	5	0.6	60°	2.3	37.9	1~1.25	4.8	15	●	●
ASITR 06V100-6215	6	0.6	60°	3	37.9	1~1.25	6.2	15	●	-
ASITR/L 06V125-6215	6	0.8	60°	3	38.1	1.25~1.5	6.2	15	●	●
ASITR/L 06V150-6215	6	1	60°	3	38.3	1.5~1.75	6.2	15	●	●

Small Tools

ASIT M Type - Small Dia. Internal ISO Threading Tool

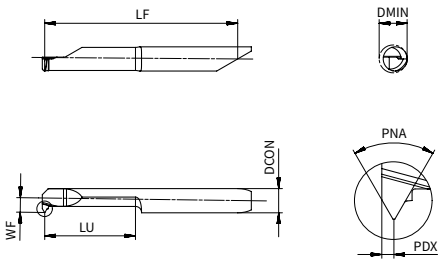

Product code	Dimension (mm)								AP220U	
	DCON	PDX	PNA	WF	LF	P	DMIN	LU	R	L
ASITR 04M050-4215	4	0.4	60°	2	32.7	0.5	4.4	15	●	-
ASITR 04M070-4215	4	0.5	60°	1.9	32.8	0.7	4.4	15	●	-
ASITR 04M080-4015	4	0.5	60°	1.9	32.8	0.8	4	15	●	-
ASITR 05M050-5215	5	0.4	60°	2.5	37.7	0.5	5.2	15	●	-
ASITR 05M075-5115	5	0.5	60°	2.4	37.8	0.75	5.1	15	●	-
ASITR 05M100-4815	5	0.6	60°	2.3	37.9	1	4.8	15	●	-
ASITR 06M100-6215	6	0.6	60°	3	37.9	1	6.2	15	●	-
ASITR 06M125-6215	6	0.7	60°	3	38	1.25	6.2	15	●	-
ASITR 06M150-6215	6	0.8	60°	3	38.1	1.5	6.2	15	●	-
ASITR 06M175-6215	6	0.9	60°	3	38.2	1.75	6.2	15	●	-
ASITR 06M200-6215	6	1	60°	3	38.3	2	6.2	15	●	-

●: Stock available ▲: Stock available now but will be replaced in the future.

ASIT U Type - Small Dia. Internal UN Threading Tool

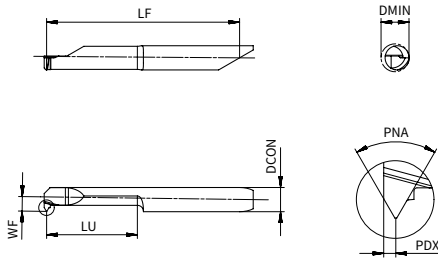

Product code	Dimension (mm)								AP220U	
	DCON	PDX	PNA	WF	LF	P	DMIN	LU	R	L
ASITR 04U032-4015	4	0.6	60°	1.9	32.9	28	4	15	●	-
ASITR 04U028-4015	4	0.6	60°	1.9	32.9	32	4	15	●	-
ASITR 04U024-4215	4	0.7	60°	2	33	24	4.2	15	●	-
ASITR 05U020-5215	5	0.7	60°	2.5	38	20	5.2	15	●	-
ASITR 06U018-6215	6	0.6	60°	3	38.1	18	6.2	15	●	-
ASITR 06U016-6215	6	0.9	60°	3	38.2	16	6.2	15	●	-

ASIT W Type - Small Dia. Internal Worth Threading Tool

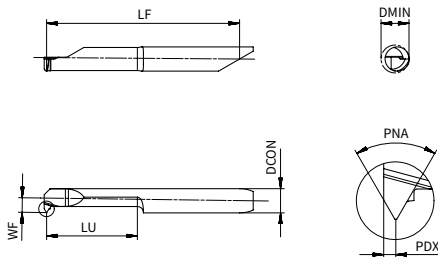

Product code	Dimension (mm)								AP220U	
	DCON	PDX	PNA	WF	LF	P	DMIN	LU	R	L
ASITR 05W028-5215	5	0.8	55°	2.5	38.1	28	5.2	15	●	-
ASITR 05W026-5215	5	0.8	55°	2.5	38.1	26	5.2	15	●	-
ASITR 05W024-5215	5	0.8	55°	2.5	38.1	24	5.2	15	●	-
ASITR 06W028-6215	6	0.8	55°	3	38.1	28	6.2	15	●	-
ASITR 06W026-6215	6	0.8	55°	3	38.1	26	6.2	15	●	-
ASITR 06W024-6215	6	0.8	55°	3	38.1	24	6.2	15	●	-
ASITR 06W022-6215	6	1	55°	3	38.3	22	6.2	15	●	-
ASITR 06W020-6215	6	1	55°	3	38.3	20	6.2	15	●	-
ASITR/L 06W019-6215	6	1	55°	3	38.3	19	6.2	15	●	●

●: Stock available ▲: Stock available now but will be replaced in the future.

ASIT N Type - Small Dia. Internal NPT Threading Tool

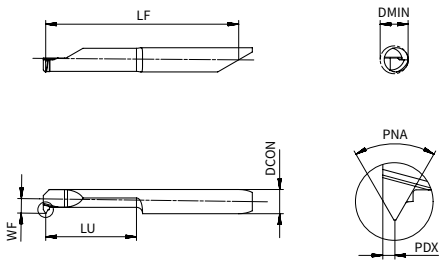

Product code	Dimension (mm)								AP220U	
	DCON	PDX	PNA	WF	LF	P	DMIN	LU	R	L
ASITR 06N027-6215	6	0.8	60°	3	38.1	27	6.2	15	●	-
ASITR/L 06N018-6215	6	1	60°	3	38.3	18	6.2	15	●	●

ASIT T Type - Small Dia. Internal TR Threading Tool

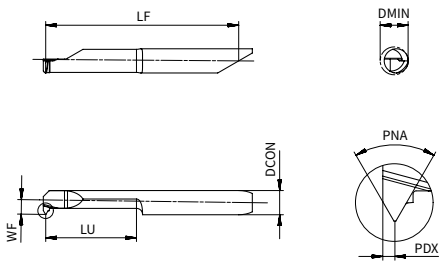













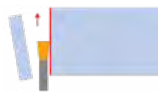

Product code	Dimension (mm)								AP220U	
	DCON	PDX	PNA	WF	LF	P	DMIN	LU	R	L
ASITR 06T150-6220	6	0.6	30°	3	38.2	1.5	6.2	20	●	-
ASITR 06T200-6220	6	0.8	30°	3	38.4	2	6.2	20	●	-

Small Tools

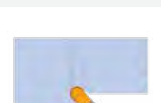
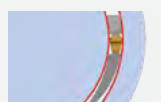











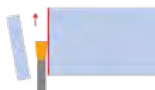

●: Stock available ▲: Stock available now but will be replaced in the future.

Overview of Grooving Holders

Holder Application			External grooving					
			ASGHR/L	S-ASGHL	ATGHR/L	ATSER/L	ATSER/L-D	ATSER/L-SW
								
Page			P151	P152	P153	P155	P157	P158
External grooving	Parting off					●	●	●
	Grooving		●	●	●	●	●	●
	Turning					●	●	●
	Profiling					●	●	
	Under cut							
Face grooving	Grooving							
	Turning							
Internal machining	Grooving							
	Turning							

Marked: ● Best choice











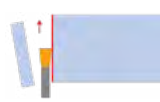

Overview of Grooving Holders

Holder Application			External grooving	Face grooving					
			AGUER/L	ATSFR/L	ATSFR/L-OB	AGSFR/L	AGPFR/L	ATPFR/L	
									
Page			P159	P160	P161	P163	P164	P165	
External grooving	Parting off								
	Grooving					●	●		
	Turning					○	○		
	Profiling								
	Under cut		●						
Face grooving	Grooving			●	●	●	●	●	●
	Turning			●	●	●	●	●	●
Internal machining	Grooving								
	Turning								

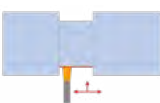
Marked: ● Best choice

Grooving

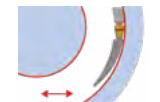
Overview of Grooving Holders

Holder Application			Internal machining				
			ATPIR/L	ATGIR/L	ATSIR/L	AGSIR/L	AGUIR/L
							
Page			P166	P167	P166	P168	P170
External grooving	Parting off						
	Grooving						
	Turning						
	Profiling						
	Under cut						●
Face grooving	Grooving				●	●	
	Turning				●	●	
Internal machining	Grooving		●	●			
	Turning		●				

Marked: ● Best choice

ASGH Grooving Holder Denomination System

A 1	S 2	G 3	H 4	R 5	20 6	20 7	JX 8	- -	32 9	F 10
1-Company Name ACHTECK		2-Matching Insert Type S S: For swiss machine		3-Application G Grooving		4-Holder Type H Holder		5-Hand of Tool L Left R Right		
6-Holder Height 20=20.0mm		7-Holder Width 20=20.0mm		8-Holder Length JX=120mm		9 -Matching Insert Size (IC) 32=9.525mm		10 -Shape of Holder Head F: Without dimple		

ASGHR/L External shallow Grooving Holder for Swiss Lathe

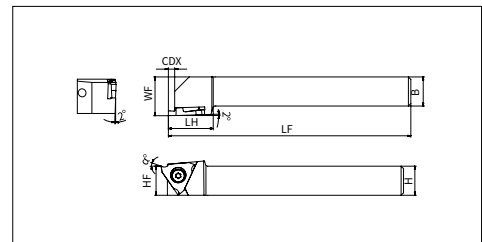
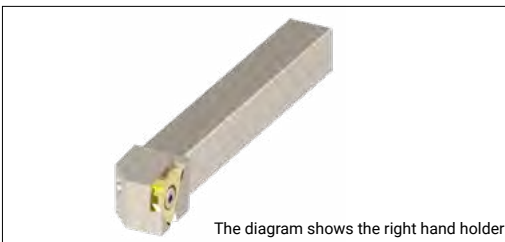

Product code		Dimension (mm)					Spare parts	
		H	B	LF	LH	CDX	Screw	Wrench
ASGHR/L	1010JX-32F	10	10	120	18.5	2.5	SP040070	FT-TP08
	1212FX-32F	12	12	85	18.5	2.5		
	1212JX-32F	12	12	120	18.5	2.5		
	1616JX-32F	16	16	120	18.5	2.5		
	2020JX-32F	16	16	120	18.5	2.5		
	1010F-32	10	10	80	18.5	2.5		
	1212H-32	12	12	100	18.5	2.5		
	1616H-32	16	16	100	18.5	2.5		
	2020K-32	20	20	125	20	2.5		
2525M-32	25	25	150	20	2.5			

Applicable Insert

Application	Grooving
Insert shape	
Product code	
ASGHR/L**	ASG 32
Reference page	P176

Grooving

S...ASGH Sleeve Tool Holder Denomination System

S 1	20 2	JX 3	- -	A 4	S 5	G 6	H 7	L 8	32 9
1-Holder Material S=Steel		2-Holder Shank Diameter 20=20mm		3-Holder Length JX=120mm		4-Company Name ACHTECK			
5-Matching Insert Type S Swiss		6-Application G Grooving		7-Holder Type H Holder		8-Hand of Tool L Left			
9-Matching Insert Size (IC) 32=9.525mm									

S...ASGH External Grooving Sleeve Holder for Swiss Lathe

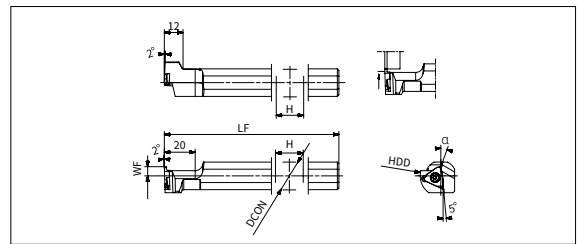

Product code	Dimension (mm)					Spare parts	
	DCON	LF	WF	HDD	DMIN	Screw	Wrench
S12F-ASGHL32	12	80	6	11	27	SP040070	FT-TP08
S14H-ASGHL32	14	100		13			
S15.0H-ASGHL32	15.875			17.6			
S16H-ASGHL32	16	18.6					
S19.0JX-ASGHL32	19.05	120		23.6			
S20JX-ASGHL32	20	120		23.6			
S22JX-ASGHL32	22	120					
S25JX-ASGHL32	25	120	10				
S25.0JX-ASGHL32	25.4	120					

Applicable Insert

Application	Grooving
Insert shape	
Product code	S...ASGHL**
Reference page	ASG 32 P176

ATGH Tool Holder Denomination System

A 1	T 2	G 3	H 4	R 5	25 6	25 7	M 8	43 9	- -	10 10	T25 11
1-Company Name ACHTECK		2-Matching Insert Type T Triangular			3-Application G Grooving		4-Holder Type H Holder				
5-Hand of Tool L Left R Right		6-Holder Height 20=20.0mm 25=25.0mm			7-Holder Width 20=20.0mm 25=25.0mm		8-Holder Length K=125mm M=150mm				
9-Matching Insert Size (IC) 32=9.525mm			10-Matching Insert Maximum Width 10=1.0mm			11-Maximum Ap T25=2.5mm					

ATGHR/L External Grooving Holder

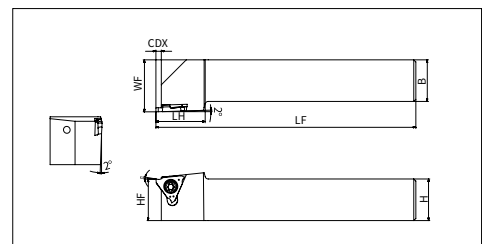
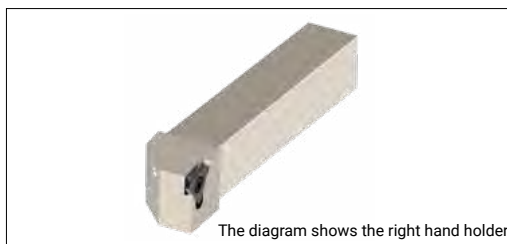

Product code		Dimension (mm)						Spare parts	
		H	B	LF	LH	WF	CDX	Screw	Wrench
ATGHR/L	2020K32-T25	20	20	20	125	24	2.5	SP040085	FT-TP15
	2525M32-T25	25	25	25	150	24	2.5		
	2020K43-10T40	20	20	20	125	25.5	4.0	SP05008550	FT-TP20
	2525M43-10T40	25	25	25	150	25.5	4.0		
	2020K43-20T45	20	20	20	125	25.5	4.5		
	2525M43-20T45	25	25	25	150	25.5	4.5		
	2020K43-20T55	20	20	20	125	25.5	5.5		
	2525M43-20T55	25	25	25	150	25.5	5.5		
	2020K43-30T55	20	20	20	125	25.5	5.5		
2525M43-30T55	25	25	25	150	25.5	5.5			

Applicable Insert

Application	Grooving	Profiling
Insert shape		
Product code		
ATGHR/L** 32	ATG 32	ATG 32
ATGHR/L** 43	ATG 43	ATG 43
Reference page	P177	P178

Grooving Holder Denomination System

A 1	G 2	U 3	E 4	R 5	25 7	25 8	- -	4 9	T25 10	- -	40 11	- -	80 12	- -	SW 13
					32 6										

1-Company Name	
ACHTECK	

2-Application	
G	Grooving
T	Turning

3- Shape of Holder Head	
S: Straight U: Under cut P: Perpendicular	

4-Machining Type	
E: External I: Internal F: Facing	

5-Hand of Tool	
L	Left hand
R	Right hand

6-Holder Diameter	
20=20.0mm 25=25.0mm 32=32.0mm	

7-Holder Height	
20=20.0mm 25=25.0mm 32=32.0mm	

8-Holder Width	
20=20.0mm 25=25.0mm 32=32.0mm	

9-Insert Width	
2=2.0mm 3=3.0mm 4=4.0mm	

10- A_p	
T25=25.0mm	

11-Minimum Cutting Diameter	
40=40.0mm	

12-Maximum Cutting Diameter	
80=80.0mm	

13-Special Code	
SW: For swiss machine OB: Outside bulge holders C: With internal coolant D: Reinforced holders	



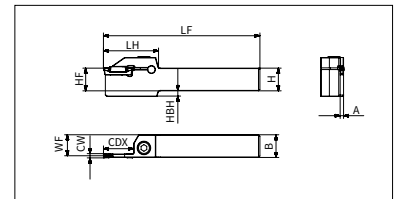
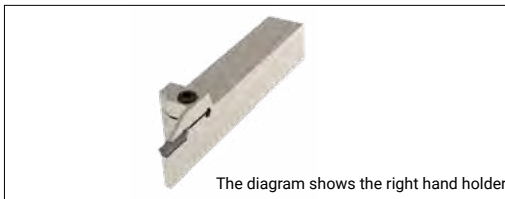





ATSER/L External Turning and Grooving



Product code		Dimension (mm)									Spare parts		
		H	B	HF	HBH	A	LF	LH	WF	CDX	Screw	Wrench	
ATSER/L	1616-2T08	16	16	16	4	1.8	110	33	15.1	8	SH050160	LT-H4	
	1616-2T12	16	16	16	4	1.8	110	32	15.1	12			
	1616-2T17	16	16	16	4	1.8	110	37	15.1	17			
	2020-2T08	20	20	20	0	1.8	125	33	19.1	8			
	2020-2T12	20	20	20	0	1.8	125	32	19.1	12			SH050200
	2020-2T17	20	20	20	0	1.8	125	37	19.1	17			
	2525-2T08	25	25	25	0	1.8	150	33	24.1	8			
	2525-2T12	25	25	25	0	1.8	150	32	24.1	12			SH050250
	2525-2T17	25	25	25	0	1.8	150	37	24.1	17			
	1616-3T09	16	16	16	4	2.4	110	32	14.8	9			
	1616-3T12	16	16	16	4	2.4	110	32	14.8	12			SH050160
	1616-3T20	16	16	16	4	2.4	110	38	14.8	20			
	2020-3T09	20	20	20	0	2.4	125	32	18.8	9			
	2020-3T12	20	20	20	0	2.4	125	32	18.8	12	SH050200		
	2020-3T20	20	20	20	0	2.4	125	38	18.8	20			
	2525-3T09	25	25	25	0	2.4	150	32	23.8	9			
	2525-3T12	25	25	25	0	2.4	150	32	23.8	12	SH050250		
	2525-3T20	25	25	25	0	2.4	150	38	23.8	20			
	2525-3T25	25	25	25	0	2.4	150	45	23.8	25			
	1616-4T10	16	16	16	4	3.35	110	32	14.3	10			
	1616-4T15	16	16	16	4	3.35	110	33	14.3	15	SH060160		
	1616-4T25	16	16	16	4	3.35	110	45	14.3	25			
	2020-4T10	20	20	20	0	3.35	125	32	18.3	10			
	2020-4T15	20	20	20	0	3.35	125	33	18.3	15	SH060200		
	2020-4T25	20	20	20	0	3.35	125	45	18.3	25			
	2525-4T10	25	25	25	0	3.35	150	32	23.3	10			
	2525-4T15	25	25	25	0	3.35	150	33	23.3	15	SH060250		
	2525-4T20	25	25	25	0	3.35	150	40	23.3	20			
	2525-4T25	25	25	25	0	3.35	150	45	23.3	25			
	2020-5T12	20	20	20	0	4.35	125	37	17.8	12			
	2020-5T20	20	20	20	0	4.35	125	37	17.8	20	SH060200		
	2525-5T12	25	25	25	0	4.35	150	37	22.8	12			
	2525-5T20	25	25	25	0	4.35	150	37	22.8	20			
	2525-5T32	25	25	25	0	4.35	150	56	22.8	32	SH060250		
	3232-5T12	32	32	32	0	4.35	170	37	29.8	12			
	3232-5T20	32	32	32	0	4.35	170	39	29.8	20			
	3232-5T25	32	32	32	0	4.35	170	46	29.8	25			
	3232-5T32	32	32	32	0	4.35	170	56	29.8	32			
	2020-6T12	20	20	20	0	5.35	125	37	17.3	12	SH080200		
	2020-6T20	20	20	20	0	5.35	125	41	17.3	20			
2525-6T12	25	25	25	7	5.35	150	37	22.3	12	SH080250			
2525-6T20	25	25	25	7	5.35	150	41	22.3	20				
2525-6T32	25	25	25	7	5.35	150	56	22.3	32				
3232-6T12	32	32	32	0	5.35	170	37	29.3	12				
3232-6T20	32	32	32	0	5.35	170	41	29.3	20				
3232-6T25	32	32	32	0	5.35	170	46	29.3	25				
3232-6T32	32	32	32	0	5.35	170	56	29.3	32				
2525-8T16	25	25	25	7	7.35	150	47	21.3	16				
2525-8T25	25	25	25	7	7.35	150	47	21.3	25				
2525-8T36	25	25	25	7	7.35	150	60	21.3	36				
3232-8T25	32	32	32	0	7.35	170	47	28.3	25				
3232-8T36	32	32	32	0	7.35	170	60	28.3	36				

Grooving

Applicable Insert

Application	Low feed rate	Low-Medium feed rate	Medium feed rate	Finishing	Low cutting force	Medium feed rate	Profiling	Ground Profiling	Ground
Insert shape	CS	CM	CH	GS	TS	TM	RM	RA	G
Product code									
ATSER/L**	ACD 202 ACD 302	ACD/ACS 202 ACD/ACS 603	ACD/ACS 202 ACD/ACS 603	ATD 300E ATD 714E	ATD 203 ATD 808	ATD 304 ATD 812	ATD 210 ATD 840	ATD 315 ATD 840	ATD 100E ATD 800E
Reference page	P179	P180	P181	P182	P183	P183	P184	P184	P186

Inserts*: ACD/ACS series are only applicable to grooving and parting off machining

ATSER/L-D Reinforced External Turning and Grooving Holder

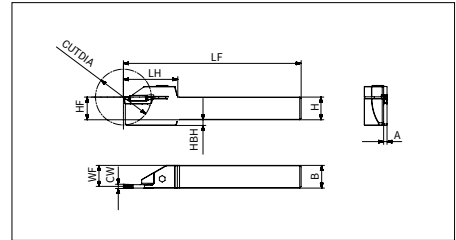
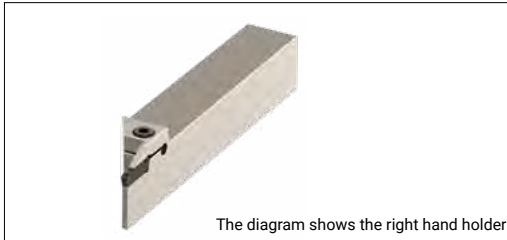

Product code		Dimension (mm)										Spare parts	
		H	B	HF	HBH	A	LF	LH	WF	CDX	CUTDIA	Screw	Wrench
ATSER/L	1010-2T15-D40	10	10	10	6	1.8	125	32	9.1	15	40	SH050160	LT-H4
	1212-2T15-D40	12	12	12	4	1.8	125	32	11.1	15	40		
	1616-2T20-D45	16	16	16	4	1.8	125	38	15.1	20	45		
	2020-2T20-D45	20	20	20	0	1.8	125	38	19.1	20	45		
	2525-2T20-D45	25	25	25	0	1.8	150	38	24.1	20	45		
	1212-3T15-D40	12	12	12	4	2.4	125	32	10.8	15	40		
	1616-3T20-D45	16	16	16	4	2.4	125	38	14.8	20	45		
	2020-3T20-D45	20	20	20	0	2.4	125	38	18.8	20	45		
	2525-3T20-D45	25	25	25	0	2.4	150	38	23.8	20	45		
2525-3T25-D60	25	25	25	7	2.4	150	43	23.8	25	60	SH050250		

Applicable Insert

Application	Low feed rate	Low-Medium feed rate	Medium feed rate	Finishing	Low cutting force	Medium feed rate	Profiling	Ground Profiling	Ground
Insert shape	CS	CM	CH	GS	TS	TM	RM	RA	G
Product code									
ATSER/L** -D	ACD 202 ACD 302	ACD/ACS 202 ACD/ACS 302	ACD/ACS 202 ACD/ACS 302	ATD 300E ATD 318E	ATD 203 ATD 303	ATD 304	ATD 210 ATD 315	ATD 315	ATD 100E ATD 300E
Reference page	P179	P180	P181	P182	P183	P183	P184	P184	P186

Inserts*: ACD/ACS series are only applicable to grooving and parting off machining

The max. cutting depth vs workpiece diameter

Product code	Workpiece diameter	CDX																
		≤8	9	10	11	12	13	14	15	17	18	19	20	21	22	23	24	25
ATSER/L	1010-2T15-D40	∞	∞	∞	269	120	79	59	40	-	-	-	-	-	-	-	-	-
	1212-2T15-D40	∞	∞	∞	269	120	79	59	40	-	-	-	-	-	-	-	-	-
	1616-2T20-D45	∞	∞	∞	∞	∞	432	193	125	76	64	57	45	-	-	-	-	-
	2020-2T20-D45	∞	∞	∞	∞	∞	432	193	125	76	64	57	45	-	-	-	-	-
	2525-2T20-D45	∞	1468	339	193	136	106	87	75	60	56	52	45	-	-	-	-	-
	1212-3T15-D40	∞	∞	∞	269	120	79	59	40	-	-	-	-	-	-	-	-	-
	1616-3T20-D45	∞	∞	∞	∞	∞	432	193	125	76	64	57	45	-	-	-	-	-
	2020-3T20-D45	∞	∞	∞	∞	∞	432	193	125	76	64	57	45	-	-	-	-	-
	2525-3T20-D45	∞	1468	339	193	136	106	87	75	60	56	52	45	-	-	-	-	-
	2525-3T25-D60	∞	∞	∞	∞	∞	∞	∞	∞	418	237	167	130	107	91	81	73	60

"∞": The diameter is infinite

Grooving

ATSER/L-SW External Turning and Grooving Holder for Swiss Lathe

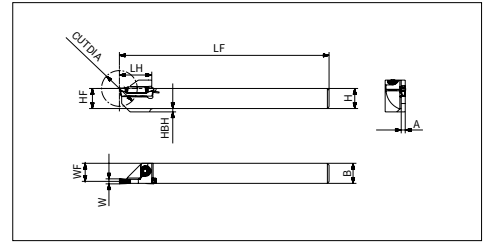
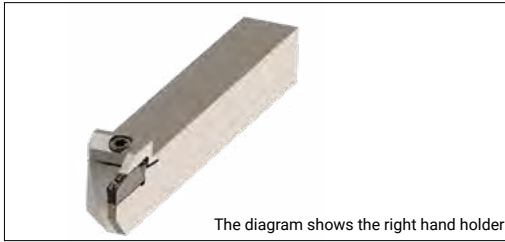

Product code		Dimension (mm)									Spare parts	
		H	B	HF	HBH	A	LF	LH	WF	CUTDIA	Screw	Wrench
ATSER/L	1010-2D20-SW	10	10	10	2	1.8	125	19	9.1	20	SP040125	LT-TP15
	1212-2D24-SW	12	12	12	2	1.8	125	19	11.1	24		
	1414-2D24-SW	14	14	14	0	1.8	125	19	13.1	24		
	1616-2D32-SW	16	16	16	0	1.8	125	24	15.1	32		
	1212-3D24-SW	12	12	12	2	2.4	125	19	10.8	24		
	1616-3D32-SW	16	16	16	0	2.4	125	24	14.8	32		
	1616-3D38-SW	16	16	16	0	2.4	125	27	14.8	38		
2020-3D45-SW	20	20	20	0	2.4	125	31	18.8	45			

Applicable Insert

Application	Low feed rate	Low-Medium feed rate	Medium feed rate	Finishing	Low cutting force	Medium feed rate	Profiling	Ground Profiling	Ground
Insert shape	CS	CM	CH	GS	TS	TM	RM	RA	G
Product code									
ATSER/L**SW	ACD 202 ACD 302	ACD/ACS 202 ACD/ACS 302	ACD/ACS 202 ACD/ACS 302	ATD 300E ATD 318E	ATD 203 ATD 303	ATD 304	ATD 210 ATD 315	ATD 315	ATD 100E ATD 300E
Reference page	P179	P180	P181	P182	P183	P183	P184	P184	P186

AGUER/L External Undercutting Holder

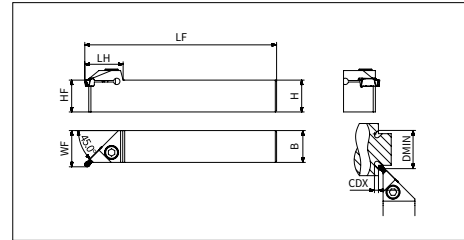
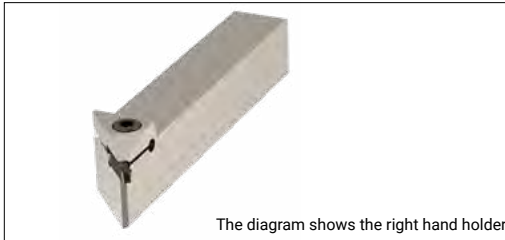

Product code	Insert width (mm)	Dimension (mm)								Spare parts		
		H	B	HF	LF	LH	WF	CDX	DMIN	Screw	Wrench	
AGUER/L	1616-3	2, 3	16	16	16	110	30.2	19.6	3	60	SH050160	LT-H4
	1616-4	4	16	16	16	110	30.2	19.8	3	55	SH060160	
	2020-3	2, 3	20	20	20	125	30.2	23.6	3	60	SH050200	LT-H5
	2020-4	4	20	20	20	125	30.2	23.8	3	55	SH060200	
	2525-3	2, 3	25	25	25	150	30.2	28.6	3	60	SH050250	LT-H4
	2525-4	4	25	25	25	150	30.2	28.8	3	55	SH060250	LT-H5
2525-6	5, 6	25	25	25	150	33.6	29.2	3.5	55			

Grooving

Applicable Insert

Application	Profiling	Ground Profiling	Ground
Insert shape	RM	RA	G
Product code			
AGUER/L**	ATD 210 ATD 630	ATD 315 ATD 630	ATD 100E ATD 600E
Reference page	P184	P184	P188

ATSFR/L Face Grooving and Turning Holder

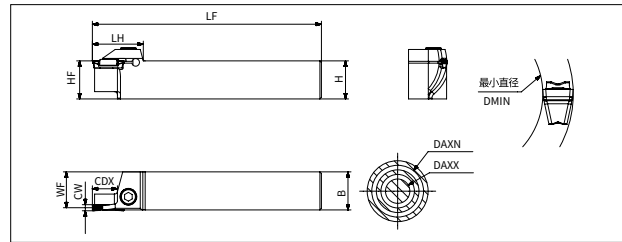
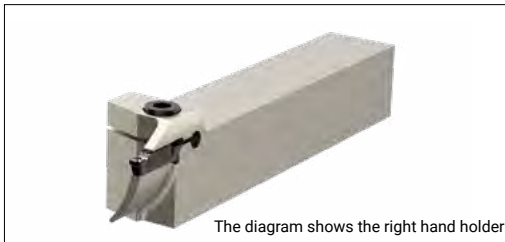
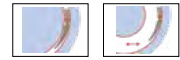

Product code		Dimension (mm)									Spare parts	
		H	B	HF	LF	LH	WF	CDX	DAXX	DAXN	Screw	Wrench
ATSFR/L	2525-3T10-35-45	25	25	25	150	32	23.95	10	35	45	SH050250	LT-H4
	2525-3T10-40-55	25	25	25	150	32	23.95	10	40	55		
	2525-3T15-45-65	25	25	25	150	32	23.95	15	45	65		
	2525-3T15-55-85	25	25	25	150	32	23.95	15	55	85	SH060250	LT-H5
	2525-4T15-35-50	25	25	25	150	32	23.55	15	35	50		
	2525-4T15-45-65	25	25	25	150	32	23.55	15	45	65		
	2525-4T15-55-85	25	25	25	150	32	23.55	15	55	85	SH080250	LT-H6
	2525-5T20-50-80	25	25	25	150	40	23.05	20	50	80		
	2525-5T20-70-110	25	25	25	150	40	23.05	20	70	110		
	2525-5T20-100-150	25	25	25	150	40	23.05	20	100	150		
	2525-5T20-140-200	25	25	25	150	40	23.05	20	140	200		
	2525-6T20-50-85	25	25	25	150	40	22.55	20	50	85		
2525-6T20-75-150	25	25	25	150	40	22.55	20	75	150	∞		
2525-6T20-140-250	25	25	25	150	40	22.55	20	140	250			
2525-6T20-200-000	25	25	25	150	40	22.55	20	200	∞			

Applicable Insert

Application		Low-Medium feed rate	Medium feed rate	Finishing	Low cutting force	Medium feed rate	Profiling	Ground
Product code	Insert shape	CM	CH	GS	TS	TM	RM	G
	Minimum machining diameter DMIN(mm)							
ATSFR/L 2525-3T		79	79	59	35	35	59	59
ATSFR/L 2525-4T		42	42	42	35	35	42	42
ATSFR/L 2525-5T		50	50	50	50	50	50	50
ATSFR/L 2525-6T		50	50	50	50	50	50	50
Reference page		P180	P181	P182	P183	P183	P184	P186

Inserts*: ACD/ACS series are only applicable to grooving and parting off machining
 Having selected the range of tool holder, please check the minimum face grooving machining diameter of the selected insert



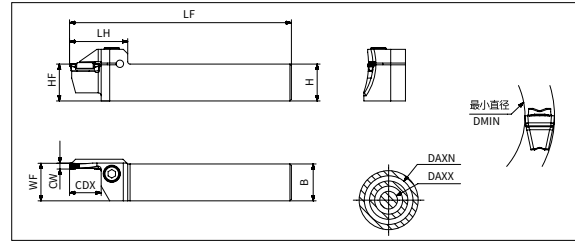
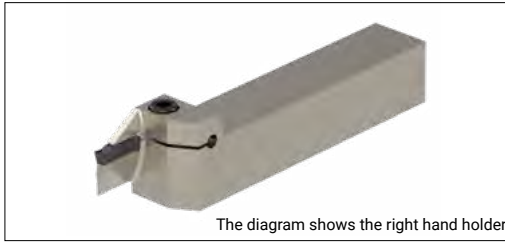
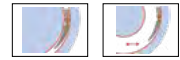



ATSFR/L-OB Face Grooving and Turning Holder (Outside Bluge Type)



Product code		Dimension (mm)									Spare parts	
		H	B	HF	LF	LH	WF	CDX	DAXX	DAXN	Screw	Wrench
ATSFR/L	2020-3T10-30-40-OB	20	20	20	140	31	18.95	10	30	40	SH060200	LT-H5
	2020-3T10-35-50-OB	20	20	20	140	31	18.95	10	35	50		
	2020-3T15-45-70-OB	20	20	20	140	35	18.95	15	45	70		
	2020-3T15-65-100-OB	20	20	20	140	35	18.95	15	65	100		
	2020-4T10-20-30-OB	20	20	20	140	31	18.55	10	20	30		
	2020-4T10-25-35-OB	20	20	20	140	31	18.55	10	25	35		
	2020-4T16-30-45-OB	20	20	20	140	36	18.55	16	30	45		
	2020-4T16-35-50-OB	20	20	20	140	36	18.55	16	35	50		
	2020-4T16-45-70-OB	20	20	20	140	36	18.55	16	45	70		
	2020-4T16-65-120-OB	20	20	20	140	36	18.55	16	65	120		
	2020-4T16-115-200-OB	20	20	20	140	36	18.55	16	115	200		
	2525-3T10-35-50-OB	25	25	25	150	38	23.95	10	35	50	SH060250	LT-H5
	2525-3T15-45-70-OB	25	25	25	150	38	23.95	15	45	70		
	2525-3T15-65-100-OB	25	25	25	150	38	23.95	15	65	100		
	2525-4T10-25-35-OB	25	25	25	150	39	23.55	10	25	35		
	2525-4T20-30-45-OB	25	25	25	150	39	23.55	20	30	45		
	2525-4T20-35-50-OB	25	25	25	150	39	23.55	20	35	50		
	2525-4T20-45-70-OB	25	25	25	150	39	23.55	20	45	70		
	2525-4T20-65-125-OB	25	25	25	150	39	23.55	20	65	125		
	2525-4T20-115-200-OB	25	25	25	150	39	23.55	20	115	200		
	2525-4T20-190-000-OB	25	25	25	150	39	23.55	20	190	∞		
	2525-5T25-50-80-OB	25	25	25	150	49	23.05	25	50	80	SH080250	LT-H6
	2525-5T15-50-80-OB	25	25	25	150	41	23.05	15	50	80		
	2525-5T25-70-110-OB	25	25	25	150	49	23.05	25	70	110		
	2525-5T15-70-110-OB	25	25	25	150	49	23.05	15	70	110		
	2525-5T25-100-150-OB	25	25	25	150	49	23.05	25	100	150		
	2525-5T25-140-200-OB	25	25	25	150	49	23.05	25	140	200		
	2525-5T25-190-000-OB	25	25	25	150	49	23.05	25	190	∞		
	2525-6T25-50-70-OB	25	25	25	150	49	22.55	25	50	70		
	2525-6T25-60-100-OB	25	25	25	150	49	22.55	25	60	100		
2525-6T25-90-180-OB	25	25	25	150	49	22.55	25	90	180			
2525-6T25-170-400-OB	25	25	25	150	49	22.55	25	170	400			
2525-6T25-390-000-OB	25	25	25	150	49	22.55	25	390	∞			

Grooving

Applicable Insert

Application	Low-Medium feed rate	Medium feed rate	Finishing	Low cutting force	Medium feed rate	Profiling	Ground
Insert shape Product code Minimum machining diameter DMIN(mm)	CM 	CH 	GS 	TS 	TM 	RM 	G 
ATSFR/L 2020-3T...OB	79	79	59	30	30	59	59
ATSFR/L 2020-4T...OB	42	42	42	22	22	42	42
ATSFR/L 2525-3T...OB	79	79	59	35	35	59	59
ATSFR/L 2525-4T...OB	42	42	42	25	25	42	42
ATSFR/L 2525-5T...OB	50	50	50	50	50	50	50
ATSFR/L 2525-6T...OB	50	50	50	50	50	50	50
Reference page	P180	P181	P182	P183	P183	P184	P186

1. Inserts*: ACD/ACS series are only applicable to grooving and parting off machining
2. Having selected the range of tool holder, please check the minimum face grooving machining diameter of the selected insert

AGSFR/L External & Face Grooving and Turning Holder

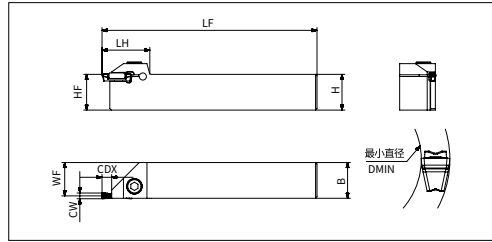
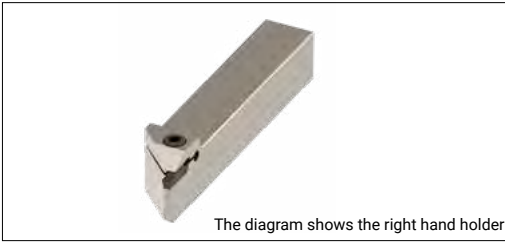
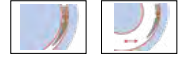

Product code	Insert width (mm)	Dimension (mm)								Spare parts	
		H	B	HF	LF	LH	WF	CDX	Screw	Wrench	
AGSFR/L	1616-4	2, 3, 4	16	16	16	110	33	14.30	4.6	SH060160	LT-H5
	2020-4	2, 3, 4	20	20	20	125	33	18.30	4.6	SH060200	
	2020-6	5, 6	20	20	20	125	37	17.30	4.6	SH060200	
	2525-4	2, 3, 4	25	25	25	150	33	23.30	4.6	SH060250	
	2525-6	5, 6	25	25	25	150	37	22.30	4.6	SH060250	

Applicable Insert

Application	Insert shape	Low feed rate	Low-Medium feed rate	Medium feed rate	Finishing	Low cutting force	Medium feed rate	Profiling	Ground
		CS	CM	CH	GS	TS	TM	RM	G
AGSFR/L**	2	196	196	196	100	196	-	196	100
	3	79	79	79	59	24	24	59	59
	4	-	42	42	42	22	22	42	42
	5	-	50	50	40	20	20	40	40
	6	-	48	48	38	18	18	38	38
Reference page		P179	P180	P181	P182	P183	P183	P184	P186

1. Inserts*: ACD/ACS series are only applicable to grooving and parting off machining
2. - : Indicates that the insert is not a choice
3. Having selected the range of tool holder, please check the minimum face grooving machining diameter of the selected insert

Grooving

AGPFR/L Face Grooving and Turning Holder

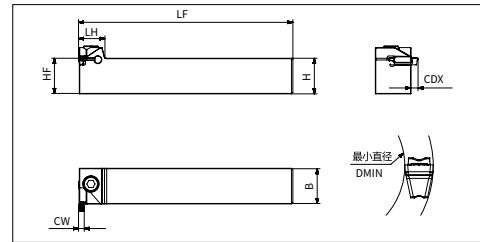
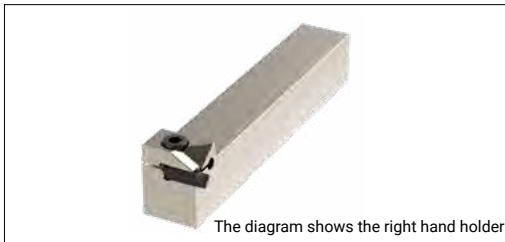
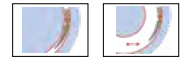

Product code		Insert width (mm)	Dimension (mm)						Spare parts	
			H	B	HF	LF	LH	CDX	Screw	Wrench
AGPFR/L	2020-4	2, 3, 4	20	20	20	125	18	4.6	SH060200	LT-H5
	2525-4	2, 3, 4	25	25	25	150	18	4.6	SH060250	LT-H5
	2525-6	5, 6	25	25	25	150	22	4.6	SH060250	LT-H5

Applicable Insert

Application	Insert shape	Insert width (mm)	Low feed rate	Low-Medium feed rate	Medium feed rate	Finishing	Low cutting force	Medium feed rate	Profiling	Ground
			CS	CM	CH	GS	TS	TM	RM	G
AGPFR/L**	Minimum machining diameter DMIN(mm)	2	196	196	196	100	196	-	196	100
		3	79	79	79	59	24	24	59	59
		4	-	42	42	42	22	22	42	42
		5	-	50	50	40	20	20	40	40
		6	-	48	48	38	18	18	38	38
Reference page			P179	P180	P181	P182	P183	P183	P184	P186

1. Inserts*: ACD/ACS series are only applicable to grooving and parting off machining
2. — : Indicates that the insert is not a choice
3. Having selected the range of tool holder, please check the minimum face grooving machining diameter of the selected insert

ATPFR/L Face Grooving and Turning Holder

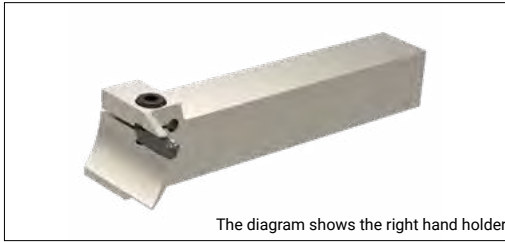
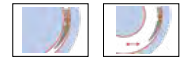

The diagram shows the right hand holder

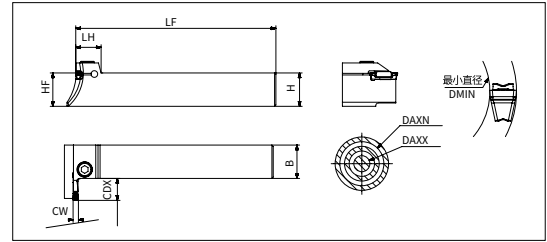

Product code	Insert width (mm)	Dimension (mm)							Spare parts		
		H	B	LF	LH	CDX	DAXX	DAXN	Screw	Wrench	
ATPFR/L	2525-3T10-30-40	3	25	25	150	18	10	30	40	SH050250	LT-H4
	2525-3T10-35-50	3	25	25	150	18	10	35	50		
	2525-3T15-45-60	3	25	25	150	18	15	45	60		
	2525-3T15-55-85	3	25	25	150	18	15	55	85		
	2525-4T12-25-40	4	25	25	150	18.5	12	25	40	SH060250	LT-H5
	2525-4T15-35-50	4	25	25	150	18.5	15	35	50		
	2525-4T15-45-60	4	25	25	150	18.5	15	45	60		
	2525-4T15-55-85	4	25	25	150	18.5	15	55	85		
	2525-5T20-50-80	5	25	25	150	22	20	50	80	SH080250	LT-H6
	2525-5T20-70-110	5	25	25	150	22	20	70	110		
	2525-5T20-100-150	5	25	25	150	22	20	100	150		
	2525-5T20-140-200	5	25	25	150	22	20	140	200		
	2525-5T20-190-000	5	25	25	150	22	20	190	∞		
	2525-6T20-50-85	6	25	25	150	22	20	50	85		
2525-6T20-75-150	6	25	25	150	22	20	75	150	∞		
2525-6T20-140-250	6	25	25	150	22	20	140	250			
2525-6T20-240-000	6	25	25	150	22	20	240	∞			

Grooving

Applicable Insert

Application	Low-Medium feed rate	Medium feed rate	Finishing	Low cutting force	Medium feed rate	Profiling	Ground
Insert shape	CM	CH	GS	TS	TM	RM	G
Product code							
Minimum machining diameter DMIN(mm)							
ATPFR/L 2525-3T	79	79	59	35	35	59	59
ATPFR/L 2525-4T	42	42	42	35	35	42	42
ATPFR/L 2525-5T	50	50	50	50	50	50	50
ATPFR/L 2525-6T	50	50	50	50	50	50	50
Reference page	P180	P181	P182	P183	P183	P184	P186





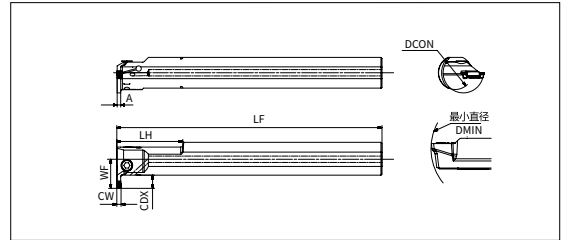
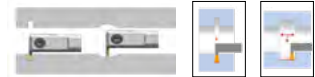

1. Inserts*: ACD/ACS series are only applicable to grooving and parting off machining
2. Having selected the range of tool holder, please check the minimum face grooving machining diameter of the selected insert

ATPIR/L Internal Turning, Grooving and Profiling Holder



Product code		Dimension (mm)							Spare parts	
		DCON	LF	LH	WF	A	CDX	DMIN	Screw	Wrench
ATPIR/L	20-2T6-25-C	20	160	40	15.8	1.8	6	25	SH050120	LT-H4
	25-2T5-25-C	25	200	40	17.5	1.8	5	25	SH050160	
	32-2T5-30-C	32	250	40	19.8	1.8	5	30	SH050160	
	20-3T6-25-C	20	160	40	15.8	2.4	6	25	SH050120	
	25-3T5-25-C	25	200	40	17.5	2.4	5	25	SH050160	
	25-3T8-32-C	25	200	40	21.5	2.4	8	32	SH050160	
	32-3T5-30-C	32	250	60	19.8	2.4	5	30	SH050160	
	32-3T10-40-C	32	200	60	27	2.4	10	40	SH050160	
	40-3T12-50-C	40	300	65	33	2.4	12	50	SH050160	
	20-4T6-25-C	20	160	40	15.8	3.35	6	25	SH050120	
	25-4T5-25-C	25	200	40	17.5	3.35	5	25	SH050160	
	25-4T8-32-C	25	200	40	21.5	3.35	8	32	SH050160	
	32-4T5-30-C	32	250	60	20.8	3.35	5	30	SH060160	LT-H5
	32-4T10-40-C	32	250	60	27	3.35	10	40	SH060160	
	40-4T12-50-C	40	300	65	33	3.35	12	50	SH060160	
	50-4T14-60-C	50	350	70	40	3.35	14	60	SH060200	
	25-5T5-31-C	25	200	40	17.3	4.35	5	31	SH060160	
	32-5T5-31-C	32	250	60	20.8	4.35	5	31	SH060200	
	32-5T10-40-C	32	250	60	27	4.35	10	40	SH060200	
	40-5T12-50-C	40	300	65	33	4.35	12	50	SH060250	
50-5T14-60-C	50	350	70	40	4.35	14	60	SH060250		
32-6T5-31-C	32	250	60	20.8	5.35	5	31	SH060200		
32-6T10-40-C	32	250	60	27	5.35	10	40	SH060200		
40-6T12-50-C	40	300	65	33	5.35	12	50	SH060250		
50-6T14-60-C	50	350	70	40	5.35	14	60	SH060250		
32-8T6-38-C	32	250	60	21.3	7.35	6	38	SH060200		
40-8T6-42-C	40	300	65	25.8	7.35	6	42	SH060250		

Applicable Insert

Application	Low-Medium feed rate	Medium feed rate	Finishing	Low cutting force	Medium feed rate	Profiling	Ground
Insert shape	CM	CH	GS	TS	TM	RM	G
Product code							
Minimum machining diameter DMIN(mm)							
ATPIR/L **-2T	-	-	25	25	25	-	25
ATPIR/L **-3T	50	50	25	25	25	25	25
ATPIR/L **-4T	50	50	25	25	25	25	25
ATPIR/L **-5T	50	50	31	31	31	31	31
ATPIR/L **-6T	50	50	31	31	31	31	31
ATPIR/L **-8T	-	-	-	38	38	38	38
Reference page	P180	P181	P182	P183	P183	P184	P186

1. Inserts*: ACD/ACS series are only applicable to grooving and parting off machining
2. - : Indicates that the insert is not a choice
3. Having selected the range of tool holder, please check the minimum face grooving machining diameter of the selected insert

ATGI Tool Holder Denomination System

A 1	T 2	G 3	I 4	R 5	25 6	S 7	43 8	- -	40 9	T30 10
1-Company Name ACHTECK		2-Matching Insert Type T Triangular		3-Application G Grooving		4-Holder Type I Internal machining		5-Hand of Tool L Left R Right		
6-Holder Size 25=25.0mm 32=32.0mm		7-Holder Length R: 220mm S: 250mm		8-Matching Insert Size (IC) 43=12.70mm		9-Minimum Internal Machining Diameter 40=40mm		10-Maximum Ap T30=3.0mm		

ATGIR/L Internal Grooving Holder

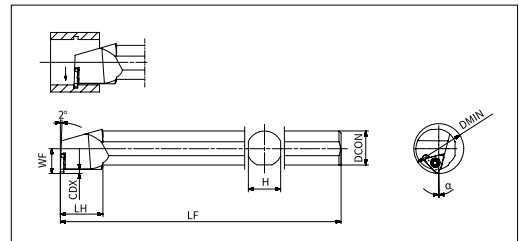
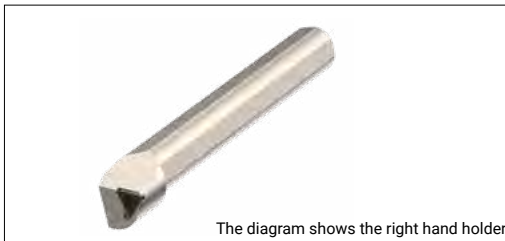

Product code		Dimension (mm)						Spare parts	
		DMIN	DCON	LF	LH	WF	CDX	Screw	Wrench
ATGIR/L	25R32-35T28	35	25	220	30	17.5	2.8	SP040085	FT-TP15
	32S43-40T30	40	32	250	30	23.0	3.0	SP05008550	FT-TP20

Applicable Insert

Application	Grooving	Profiling
Insert shape		
Product code		
ATGIR/L** 32	ATG 32	ATG 32
ATGIR/L** 43	ATG 43	ATG 43
Reference page	P177	P178





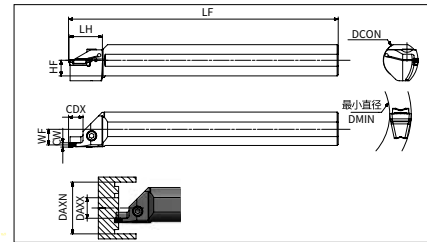
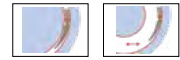

Grooving

ATSIR/L Internal Facing Grooving and Turning Holder



Product code		Dimension (mm)								Spare parts	
		DCON	LF	LH	WF	A	CDX	DMIN	DMAX	Screw	Wrench
ATSIR/L	25-3T12-35-45-C	25	200	31	11.5	11.5	12	35	45	SH050160	LT-H4
	25-3T12-40-60-C	25	200	31	11.5	11.5	12	40	60		
	25-3T12-55-90-C	25	200	31	11.5	11.5	12	55	90		
	25-3T12-80-150-C	25	200	31	11.5	11.5	12	80	150		
	25-4T12-20-35-C	25	200	31	11	11.5	12	20	35		
	25-4T12-28-45-C	25	200	31	11	11.5	12	28	45		
	25-4T12-35-55-C	25	200	31	11	11.5	12	35	55		
	32-4T12-45-70-C	32	250	31	14.5	15	12	45	70		
	32-4T12-60-100-C	32	250	31	14.5	15	12	60	100		
32-4T12-90-180-C	32	250	31	14.5	15	12	90	180			

Applicable Insert

Application	Low-Medium feed rate	Medium feed rate	Finishing	Low cutting force	Medium feed rate	Profiling	Ground
Insert shape	CM	CH	GS	TS	TM	RM	G
Product code							
Minimum machining diameter DMIN(mm)							
ATSIR/L **3T	80	80	59	35	35	59	59
ATSIR/L **4T	42	42	42	22	22	42	42
Reference page	P180	P181	P182	P183	P183	P184	P186

1. Inserts*: ACD/ACS series are only applicable to grooving and parting off machining
2. Having selected the range of tool holder, please check the minimum face grooving machining diameter of the selected insert

AGSIR/L Internal Facing Grooving and Turning Holder

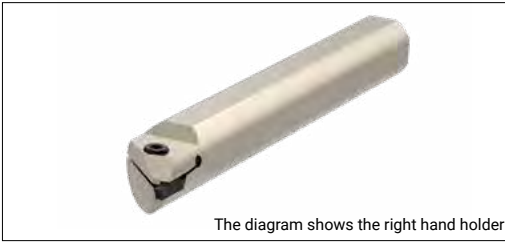
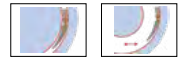

The diagram shows the right hand holder

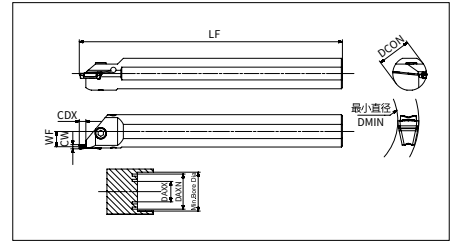

Product code		Insert width (mm)	Dimension (mm)					Spare parts	
			DCON	LF	LH	WF	CDX	Screw	Wrench
AGSIR/L	25-4T5-C	2, 3, 4	25	200	12.3	10.9	5.8	SH060160	LT-H5
	25-6T5-C	5, 6	25	200	12.3	10.3	5.8		
	32-4T5-C	2, 3, 4	32	250	15.8	14.5	5.8		
	32-6T5-C	5, 6	32	250	15.8	13.79	5.8		

Applicable Insert

Application	Insert shape	Insert width (mm)	Low feed rate	Low-Medium feed rate	Medium feed rate	Finishing	Low cutting force	Medium feed rate	Profiling	Ground
			CS	CM	CH	GS	TS	TM	RM	G
AGSIR/L**	Minimum machining diameter DMIN(mm)	2	196	196	196	100	196	-	196	100
		3	79	79	79	59	24	24	59	59
		4	-	42	42	42	22	22	42	42
		5	-	50	50	40	20	20	40	40
		6	-	48	48	38	18	18	38	38
Reference page			P179	P180	P181	P182	P183	P183	P184	P186

1. Inserts*: ACD/ACS series are only applicable to grooving and parting off machining
2. - : Indicates that the insert is not a choice
3. Having selected the range of tool holder, please check the minimum face grooving machining diameter of the selected inser

Grooving

AGUIR/L Internal Undercutting holder

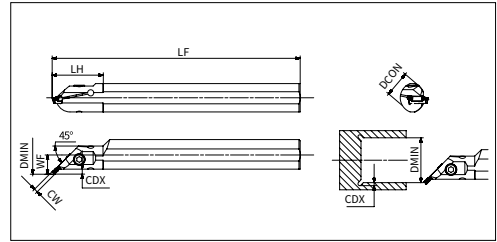
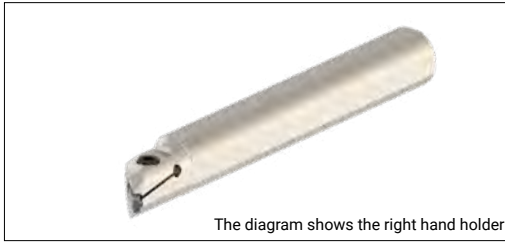

Product code		Dimension (mm)						Spare parts	
		DCON	LF	LH	WF	CDX	DIMN	Screw	Wrench
AGUIR/L	20-3T3-45	20	160	40	12.3	3	45	SH050120	LT-H4
	20-4T3-45	20	160	40	12.3	3	45		
	25-3T3-45	25	200	40	14.4	3	45	SH050160	
	25-4T3-45	25	200	40	14.4	3	45		
	25-6T3-45	25	200	40	14.4	3	45	SH060160	

Applicable Insert

Application	Profiling	Ground Profiling	Ground
Insert shape	RM	RA	G
Product code			
AGUER/L**	ATD 315 ATD 630	ATD 315 ATD 630	ATD 300E ATD 600E
Reference page	P184	P184	P188

Grooving Grade Description

Grade for Parting off and Grooving

P

Steel, cast steel, long chipping malleable cast iron.

Basic grade

AP301U P25(P15-P35)

PVD coated grade, suitable for steel, stainless steel and heat resistant alloy grooving. High strength and wear resistant submicron carbide substrate with nanostructured PVD coating. Good coating adhesion, high wear resistance.

AC230P P20(P10-P30)

CVD coated grade. It's mainly used in steel, grey cast iron and nodular cast iron grooving, turning and profiling under high cutting speed. High toughness and wear resistant substrate combined with nano-structured coating offered good wear resistance, coating adhesion, machining stability and longer tool life.

Supplemental grade

AP330M P35(P25-P45)

Brand new PVD coated grade. Suitable for stainless steel and steel finish, semi-finish and rough grooving. It's the 1st choice for stainless steel turning, and good for steel turning as well. It has high thermal stability, wear resistance, and excellent thermal crack resistance. Enriched cobalt superfine grain substrate offers high hardness and good anti shock capability which reduces the edge chipping problem.

M

Austenitic/ferrite/martensite, cast iron, manganese steel, alloyed cast iron, malleable cast iron, free cutting iron

Basic grade

AP330M M35(M25-M45)

Brand new PVD coated grade. Suitable for stainless steel and steel finish, semi-finish and rough grooving. It's the 1st choice for stainless steel turning, and good for steel turning as well. It has high thermal stability, wear resistance, and excellent thermal crack resistance. Enriched cobalt superfine grain substrate offers high hardness and good anti shock capability which reduces the edge chipping problem.

Supplemental grade

AP301U M20(M15-M35)

PVD coated grade. Suitable for steel, stainless steel and heat resistant alloy grooving. High strength and wear resistant submicron carbide substrate with nanostructured PVD coating. Good coating adhesion, high wear resistance.

N

Non-ferrous metal

Basic grade

AW100K N15 (N05-N25)

Uncoated ultra-fine grain substrate, specially treated cutting edge, suitable for aluminum alloy grooving.

ACHTTECK











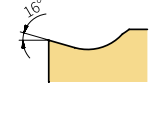

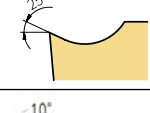



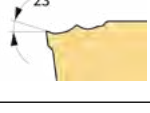

www.achtecktool.com/en

THE EXPERT OF DIFFICULT MACHINING

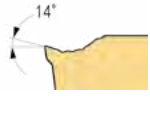
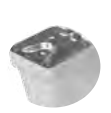
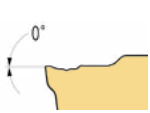

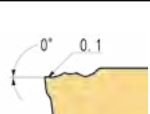
Grooving Inserts

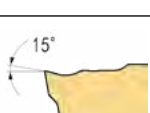
Insert Geometry Introduction

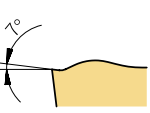
Geometry	Insert	Shape of cutting edge	Description	Geometry Width (mm)									
				External Machining					Face grooving		Internal Machining		
				Grooving	Parting off	Turning	Profiling	Under cut	Grooving	Turning	Grooving	Turning	
ATG			<ul style="list-style-type: none"> ● Use precision insert ● Positive insert reduces the vibration ● 3 edge design, with good expansibility. 	0.33	-	-	0.5 1.0 1.5 2.0 3.0 4.0	-	-	-	0.33	-	
				4.8									4.8
ASG			<ul style="list-style-type: none"> ● Use precision insert ● Big rake angle and sharp edge design obtain good surface quality. ● 3 edge design 	0.8	-	-	-	-	-	-	0.8	-	
				2.5									2.5
CS			<ul style="list-style-type: none"> ● Used in parting off & grooving stainless steel, heat resistant alloy and low carbon steel ● For low feed rate application 	2.0	2.0	-	-	-	3.0	-	3.0	-	
				3.0	3.0								
CM			<ul style="list-style-type: none"> ● Used in parting off & grooving low carbon steel and stainless steel ● For sticky material, pipe fitting, thin-walled part parting off, low cutting force ● For low to medium feed rate 	2.0	2.0	-	-	-	3.0	-	3.0	-	
				3.0	3.0								
				4.0	4.0								
				5.0	5.0								
				6.0	6.0								
CH			<ul style="list-style-type: none"> ● Used in parting off and grooving steel, alloy steel and stainless steel with high hardness and toughness. ● Strong cutting edge ● For parting off and grooving at medium to high feed rate 	2.0	2.0	-	-	-	3.0	-	3.0	-	
				3.0	3.0								
				4.0	4.0								
				5.0	5.0								
				6.0	6.0								
GS			<ul style="list-style-type: none"> ● Excellent chip breaking, suitable for grooving and finish turning. ● Geometry for finish machining, low cutting force, low feed, excellent surface quality. ● Ground insert, better precision control and positioning repeatability. 	2.0	2.0	2.0	-	-	3.0	3.0	2.0	2.0	
				7.14	7.14	7.14							
				7.14	7.14	7.14							
TS			<ul style="list-style-type: none"> ● Multifunctional insert for external, internal turning and grooving, parting off, face grooving and face turning ● Excellent chip control ● For low and medium feed rate. 	2.0	2.0	2.0	-	-	3.0	3.0	2.0	2.0	
				3.0	3.0	3.0							
				4.0	4.0	4.0							
				5.0	5.0	5.0							
				6.0	6.0	6.0							
				8.0	8.0	8.0							
TM			<ul style="list-style-type: none"> ● Multifunctional insert for external, internal turning and grooving, parting off, face grooving and face turning ● Stronger cutting edge design ● For medium feed rate 	2.0	2.0	2.0	-	-	3.0	3.0	2.0	2.0	
				3.0	3.0	3.0							
				4.0	4.0	4.0							
				5.0	5.0	5.0							
				6.0	6.0	6.0							
				8.0	8.0	8.0							
RM			<ul style="list-style-type: none"> ● External grooving, turning, profiling ● Medium feed rate 	2.0	-	2.0	2.0	2.0	3.0	3.0	2.0	2.0	
				3.0									3.0
				4.0									4.0
				5.0									5.0
				6.0									6.0
				8.0									8.0
RA			<ul style="list-style-type: none"> ● For turning and profiling aluminum alloy ● High positive rake angle and sharp cutting edge ● Ground inserts with high precision 	3.0	-	3.0	3.0	3.0	3.0	3.0	3.0	3.0	
				4.0									4.0
				5.0									5.0
				6.0									6.0
				8.0									8.0
Precision ground			<ul style="list-style-type: none"> ● Ground insert with high precision, better precision control ● Complete product offering ● Good surface quality 	1.0	-	2.22	3.0	3.0	3.0	3.0	2.22	2.22	
				4.8									4.8
				8.0									8.0

Grooving

Grade Application Guide

Materials				Turning grade application			
				PVD coated		CVD coated	Uncoated
ISO	Material classification	Tensile strength (N/mm ²)	Hardness (HB)	AP301U	AP330M	AC230P	AW100K
P	Unalloyed steel	<600	<180	●	●	●	-
		<950	<280	●	●	●	-
	Alloyed steel	700-950	200-280	●	●	●	-
		950-1200	280-355	●	●	●	-
		1200-1400	355-415	●	●	●	-
M	Duplex stainless steel	778	230	●	●	-	-
	Austenitic stainless steel	675	200	●	●	-	-
	Precipitation-hardening stainless steel	1013	300	●	●	-	-
K	Grey cast iron	700	220	◐	-	●	-
	Nodular cast iron	880	260	◐	-	●	-
	Malleable cast iron	800	250	◐	-	●	-
N	Aluminum	260	75	-	-	-	●
	Aluminum alloy	447	130	-	-	-	●
S	Fe-based alloy	943	280	-	-	-	-
	Co-based alloy	1076	320	-	-	-	-
	Ni-based alloy	1177	350	-	-	-	-
	Ti-alloy	1262	370	-	-	-	-
H	Hardened steel	-	50-60HRC	-	-	-	-
	Chilled cast iron	-	55HRC	-	-	-	-

- 1st choice
- ◐ 2nd choice
- Inapplicable

Triangular Shallow Grooving Insert Denomination System

A	T	G	32	R/L	050	T12	-	R005
1	2	3	4	5	6	7	-	8

1-Company Name	
ACHTECK	

2-Insert Type	
T	Triangular
S	Only applied to Swiss machine

3-Application	
G	Grooving

4-Insert IC Size	
32=9.525mm	
43=12.70mm	

5-Hand of Tool	
L	Left
R	Right

6-Insert Width	
050=0.5mm	

7-Max Ap	
T12=1.2mm	

8-Insert Corner	
R005=0.05mm	

Shallow Grooving Series

ASG: Applied to external shallow grooving for Swiss machine

Product code	IC	S	D1
ASG 32-	9.525	3.18	4.6

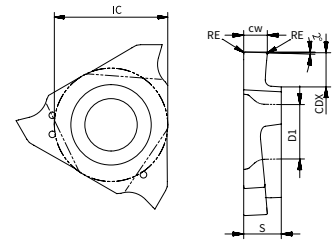

The diagram shows the right hand insert

Inserts	Product code	Cutting parameter		Dimensions		Machining conditions							
		Grooving f (mm/rev)	CDX	CW	RE	P		M		K		N	
						AC230P	AP301U	AP330M	AP301U	AP330M	AC230P	AP301U	AW100K
	ASG 32R/L033T08-R005	0.01-0.05	0.8	0.33	0.05		●		●			●	
	ASG 32R/L050T12-R005	0.01-0.05	1.2	0.50	0.05		●		●			●	
	ASG 32R/L075T20-R010	0.02-0.07	2.0	0.75	0.10		●		●			●	
	ASG 32R/L095T20-R010	0.02-0.07	2.0	0.95	0.10		●		●			●	
	ASG 32R/L100T20-R010	0.03-0.08	2.0	1.00	0.10		●		●			●	
	ASG 32R/L120T20-R010	0.03-0.08	2.0	1.20	0.10		●		●			●	
	ASG 32R/L125T20-R010	0.03-0.08	2.0	1.25	0.10		●		●			●	
	ASG 32R/L140T20-R010	0.03-0.08	2.0	1.40	0.10		●		●			●	
	ASG 32R/L145T20-R010	0.03-0.08	2.0	1.45	0.10		●		●			●	
	ASG 32R/L150T20-R010	0.03-0.08	2.0	1.50	0.10		●		●			●	
	ASG 32R/L175T20-R010	0.03-0.08	2.0	1.75	0.10		●		●			●	
	ASG 32R/L200T25-R010	0.03-0.08	2.5	2.00	0.10		●		●			●	
	ASG 32R/L250T25-R010	0.03-0.08	2.5	2.50	0.10		●		●			●	

●: Stock available ▲: Stock available now but will be replaced in the future.

Shallow Grooving Series

ATG: Applied to external and internal shallow grooving

Product code	IC	S	D1
ATG 32-	9.525	3.18	4.4
ATG 43-	12.7	4.76	5.5
ATG 43R/L480	12.7	5.0	5.5

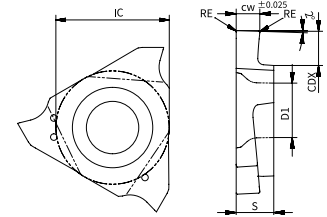

The diagram shows the right hand insert

Inserts	Product code	Machining conditions				● Good condition ⬤ General condition ✖ Bad condition							
		Cutting parameter		Dimensions		P		M		K		N	
		Grooving f (mm/rev)	CDX	CW	RE	AC230P	AP301U	AP330M	AP301U	AP330M	AC230P	AP301U	AW100K
	*ATG 32R/L033T08-R005	0.03-0.08	0.8	0.33	0.05		●		●			●	
	ATG 32R/L050T12-R005	0.03-0.08	1.2	0.50	0.05		●		●			●	
	ATG 32R/L075T20-R005	0.03-0.08	2.0	0.75	0.05		●		●			●	
	ATG 32R/L095T20-R005	0.03-0.08	2.0	0.95	0.05		●		●			●	
	ATG 32R/L100T20-R005	0.03-0.08	2.0	1.00	0.05		●		●			●	
	ATG 32R/L110T20-R005	0.03-0.08	2.0	1.10	0.05		●		●			●	
	ATG 32R/L120T20-R005	0.03-0.08	2.0	1.20	0.05		●		●			●	
	ATG 32R/L125T20-R020	0.04-0.09	2.0	1.25	0.20		●		●			●	
	ATG 32R/L130T20-R020	0.04-0.09	2.0	1.30	0.20		●		●			●	
	ATG 32R/L140T25-R020	0.04-0.09	2.5	1.40	0.20		●		●			●	
	ATG 32R/L145T25-R020	0.04-0.09	2.5	1.45	0.20		●		●			●	
	ATG 32R/L150T25-R020	0.04-0.09	2.5	1.50	0.20		●		●			●	
	ATG 32R/L160T25-R020	0.04-0.09	2.5	1.60	0.20		●		●			●	
	ATG 32R/L170T25-R020	0.04-0.09	2.5	1.70	0.20		●		●			●	
	ATG 32R/L175T25-R020	0.04-0.09	2.5	1.75	0.20		●		●			●	
	ATG 32R/L200T25-R020	0.04-0.09	2.5	2.00	0.20		●		●			●	
	ATG 32R/L225T25-R020	0.04-0.09	2.5	2.25	0.20		●		●			●	
	ATG 32R/L250T25-R020	0.05-0.10	2.5	2.50	0.20		●		●			●	
	ATG 32R/L300T25-R020	0.05-0.10	2.5	3.00	0.20		●		●			●	
	ATG 43R/L100T20-R010	0.03-0.08	2.0	1.00	0.10		●		●			●	
	ATG 43R/L125T20-R010	0.04-0.09	2.0	1.25	0.10		●		●			●	
	ATG 43R/L125T20-R020	0.04-0.09	2.0	1.25	0.20		●		●			●	
	ATG 43R/L130T30-R010	0.04-0.09	3.0	1.30	0.10		●		●			●	
	ATG 43R/L130T30-R020	0.04-0.09	3.0	1.30	0.20		●		●			●	
	ATG 43R/L140T35-R020	0.04-0.09	3.5	1.40	0.20		●		●			●	
	ATG 43R/L145T35-R020	0.04-0.09	3.5	1.45	0.20		●		●			●	
	ATG 43R/L150T35-R010	0.04-0.09	3.5	1.50	0.10		●		●			●	
	ATG 43R/L150T35-R020	0.04-0.09	3.5	1.50	0.20		●		●			●	
	ATG 43R/L170T35-R020	0.04-0.09	3.5	1.70	0.20		●		●			●	
	ATG 43R/L175T35-R020	0.04-0.09	3.5	1.75	0.20		●		●			●	
	ATG 43R/L185T35-R020	0.04-0.09	3.5	1.85	0.20		●		●			●	
	ATG 43R/L195T35-R020	0.04-0.09	3.5	1.95	0.20		●		●			●	

*ATG 32R/L033 Insert appearance is yellow

●: Stock available ▲: Stock available now but will be replaced in the future.

Grooving

Shallow Grooving Series

ATG: Applied to external and internal shallow grooving

Product code	IC	S	D1
ATG 32-	9.525	3.18	4.4
ATG 43-	12.7	4.76	5.5
ATG 43R/L480	12.7	5.0	5.5

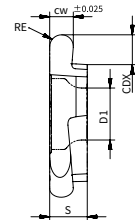
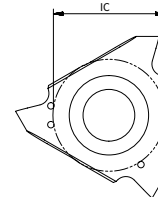
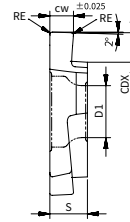
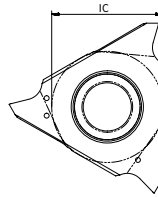

The diagram shows the right hand insert

The diagram shows the right hand insert

Inserts	Product code	Cutting parameter		Dimensions		Machining conditions							
		Grooving f (mm/rev)	CDX	CW	RE	● Good condition		⊕ General condition		⊖ Bad condition			
						P	M	K	N				
						AC230P	AP301U	AP330M	AP301U	AP330M	AC230P	AP301U	AW100K
	ATG 43R/L200T35-R010	0.04-0.09	3.5	2.00	0.10		●		●			●	
	ATG 43R/L200T35-R020	0.04-0.09	3.5	2.00	0.20		●		●			●	
	ATG 43R/L225T35-R020	0.04-0.09	3.5	2.25	0.20		●		●			●	
	ATG 43R/L230T35-R020	0.05-0.10	3.5	2.30	0.20		●		●			●	
	ATG 43R/L250T50-R010	0.05-0.10	5.0	2.50	0.10		●		●			●	
	ATG 43R/L250T50-R030	0.05-0.10	5.0	2.50	0.30		●		●			●	
	ATG 43R/L265T50-R030	0.05-0.10	5.0	2.65	0.30		●		●			●	
	ATG 43R/L280T50-R030	0.05-0.10	5.0	2.80	0.30		●		●			●	
	ATG 43R/L300T50-R010	0.05-0.10	5.0	3.00	0.10		●		●			●	
	ATG 43R/L300T50-R030	0.05-0.10	5.0	3.00	0.30		●		●			●	
	ATG 43R/L325T50-R030	0.05-0.10	5.0	3.50	0.30		●		●			●	
	ATG 43R/L330T50-R030	0.05-0.12	5.0	3.30	0.30		●		●			●	
	ATG 43R/L350T50-R010	0.05-0.12	5.0	3.50	0.10		●		●			●	
	ATG 43R/L350T50-R030	0.05-0.12	5.0	3.50	0.30		●		●			●	
	ATG 43R/L400T50-R010	0.05-0.12	5.0	4.00	0.10		●		●			●	
	ATG 43R/L400T50-R040	0.05-0.12	5.0	4.00	0.40		●		●			●	
ATG 43R/L430T50-R040	0.05-0.12	5.0	4.30	0.40		●		●			●		
ATG 43R/L450T50-R040	0.05-0.12	5.0	4.50	0.40		●		●			●		
ATG 43R/L480T50-R040	0.05-0.12	5.0	4.80	0.40		●		●			●		
	ATG 32R/L050T20-R025	0.03-0.08	1.2	0.50	0.25		●		●			●	
	ATG 32R/L100T20-R050	0.03-0.08	2.0	1.00	0.50		●		●			●	
	ATG 32R/L150T25-R075	0.04-0.09	2.5	1.50	0.75		●		●			●	
	ATG 32R/L200T25-R100	0.04-0.09	2.5	2.00	1.00		●		●			●	
	ATG 32R/L300T25-R150	0.05-0.10	2.5	3.00	1.50		●		●			●	
	ATG 43R/L100T20-R050	0.03-0.08	2.0	1.00	0.50		●		●			●	
	ATG 43R/L150T35-R075	0.04-0.09	3.5	1.50	0.75		●		●			●	
	ATG 43R/L200T35-R100	0.04-0.09	3.5	2.00	1.00		●		●			●	
	ATG 43R/L250T40-R125	0.05-0.10	5.0	2.50	1.25		●		●			●	
	ATG 43R/L300T40-R150	0.05-0.10	5.0	3.00	1.50		●		●			●	
	ATG 43R/L400T50-R200	0.05-0.12	5.0	4.00	2.00		●		●			●	

●: Stock available ▲: Stock available now but will be replaced in the future.

Insert Denomination System

A 1	C 2	D 3	4 4	0 5	3 5	- -	CM 6	- -	6 7	R 8
---------------	---------------	---------------	---------------	---------------	---------------	---------------	----------------	---------------	---------------	---------------

1-Company Name ACHTECK	2-Application C Grooving/Parting off T Turning/Grooving	3-Insert Shape S Single-edged D Double-edged	4-Insert Width 2=2.0mm 3=3.0mm 4=4.0mm
----------------------------------	--	---	--

5-Insert Corner 02=0.2mm 03=0.3mm 04=0.4mm	6-Geometry CS CM CH GS TS TM RM RA	7-Cutting Edge Angle 6=6° 15=15°	8-Hand of Tool L: Left R: Right
--	---	---	--

Grooving

Parting Off-Grooving Series

CS: Double-edged inserts applicable to parting off and grooving

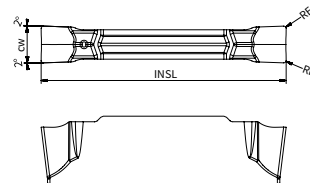

Inserts	Product code	Cutting parameter		Dimensions				Machining conditions							
								● Good condition ⬤ General condition ✖ Bad condition							
								P		M		K		N	
CDX	f (mm/rev)	CW	RE	INSL	S	AC230P	AP301U	AP330M	AP301U	AP330M	AC230P	AP301U	AW100K		
	ACD 202-CS	19.7	0.04-0.13	2	0.2	20	5.1	●	●	●	●		●		
	ACD 302-CS	19.7	0.05-0.15	3	0.2	20	5.1	●	●	●	●		●		

●: Stock available ▲: Stock available now but will be replaced in the future.

Parting Off-Grooving Series

CM: Double-edged inserts applicable to parting off and grooving

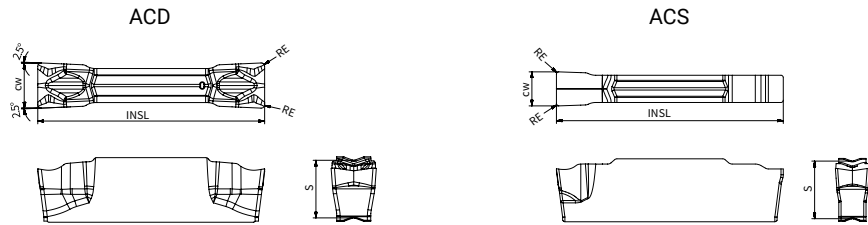

Inserts	Product code	Cutting parameter		Dimensions				Machining conditions							
								● Good condition ◐ General condition ✖ Bad condition							
								P		M		K		N	
CDX	f (mm/rev)	CW	RE	INSL	S	AC230P	AP301U	AP330M	AP301U	AP330M	AC230P	AP301U	AW100K		
	ACD 202-CM	19.7	0.04-0.15	2	0.2	20	5.1		●	●	●	●		●	
	ACD 202-CM-6R	19.7	0.03-0.09	2	0.2	20.7	5.1		●	●	●	●		●	
	ACD 202-CM-6L	19.7	0.03-0.09	2	0.2	20.7	5.1		●		●			●	
	ACD 202-CM-15R	19.7	0.03-0.09	2	0.2	21	5.1		●	●	●	●		●	
	ACD 202-CM-15L	19.7	0.03-0.09	2	0.2	21	5.1		●		●			●	
	ACD 302-CM	19.7	0.05-0.16	3	0.2	20	5.1		●	●	●	●		●	
	ACD 302-CM-6R	19.7	0.04-0.14	3	0.2	20.7	5.1		●		●			●	
	ACD 302-CM-6L	19.7	0.04-0.14	3	0.2	20.7	5.1		●	●	●	●		●	
	ACD 302-CM-15R	19.7	0.04-0.14	3	0.2	21	5.1		●	●	●	●		●	
	ACD 302-CM-15L	19.7	0.04-0.14	3	0.2	21	5.1		●		●			●	
	ACD 403-CM	19.7	0.06-0.18	4	0.3	20	5.1		●	●	●	●		●	
	ACD 403-CM-4R	19.7	0.05-0.16	4	0.3	20.7	5.1		●	●	●	●		●	
	ACD 403-CM-4L	19.7	0.05-0.16	4	0.3	20.7	5.1		●	●	●	●		●	
	ACD 503-CM	24.7	0.06-0.20	5	0.3	25	5.0		●		●			●	
	ACD 503-CM-4R	24.7	0.06-0.18	5	0.3	25.7	5.0								
	ACD 503-CM-4L	24.7	0.06-0.18	5	0.3	25.7	5.0								
ACD 603-CM	24.0	0.06-0.22	6	0.3	25	5.0		●		●			●		
	ACS 202-CM	-	0.04-0.15	2	0.2	20	5.1		●	●	●	●		●	
	ACS 302-CM	-	0.05-0.16	3	0.2	20	5.1		●		●			●	
	ACS 403-CM	-	0.06-0.18	4	0.3	20	5.1								
	ACS 503-CM	-	0.06-0.20	5	0.3	25	5.0								
	ACS 603-CM	-	0.06-0.22	6	0.3	25	5.0								



Remark: 1. if R/L style inserts are selected, the feed need to be reduced by 20-40%.
 2. ACS single edged insert's Tmax is determined according to the tool holder.

●: Stock available ▲: Stock available now but will be replaced in the future.

Parting Off-Grooving Series

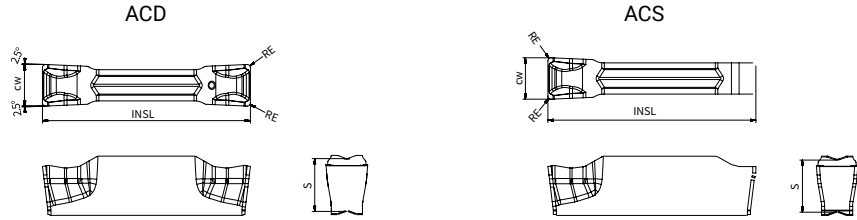
CH: Double-edged inserts applicable to parting off and grooving



Inserts	Product code	Cutting parameter		Dimensions				Machining conditions							
								● Good condition ⬤ General condition ✖ Bad condition							
								P		M		K		N	
CDX	f (mm/rev)	CW	RE	INSL	S	AC230P	AP30TU	AP330M	AP30TU	AP330M	AC230P	AP30TU	AW100K		
	ACD 202-CH	19.7	0.05-0.20	2	0.2	20	5.1		●	●	●	●		●	
	ACD 202-CH-6R	19.7	0.04-0.16	2	0.2	20.7	5.1		●	●	●	●		●	
	ACD 202-CH-6L	19.7	0.04-0.16	2	0.2	20.7	5.1		●		●			●	
	ACD 202-CH-15R	19.7	0.04-0.15	2	0.2	21	5.1		●	●	●	●		●	
	ACD 202-CH-15L	19.7	0.04-0.15	2	0.2	21	5.1		●		●			●	
	ACD 302-CH	19.7	0.07-0.25	3	0.2	20	5.1		●	●	●	●		●	
	ACD 302-CH-6R	20.7	0.05-0.20	3	0.2	20.7	5.1		●	●	●	●		●	
	ACD 302-CH-6L	21.7	0.05-0.20	3	0.2	20.7	5.1		●	●	●	●		●	
	ACD 302-CH-15R	20	0.05-0.18	3	0.2	21	5.1		●	●	●	●		●	
	ACD 302-CH-15L	20	0.05-0.18	3	0.2	21	5.1		●		●			●	
	ACD 403-CH	19	0.08-0.30	4	0.3	20	5.1		●	●	●	●		●	
	ACD 403-CH-4R	19.7	0.06-0.25	4	0.3	20.7	5.1		●	●	●	●		●	
	ACD 403-CH-4L	19.7	0.06-0.25	4	0.3	20.7	5.1		●	●	●	●		●	
	ACD 503-CH	24	0.09-0.35	5	0.3	25	5.0		●	●	●	●		●	
	ACD 503-CH-4R	24.7	0.08-0.30	5	0.3	25.7	5.0		●	●	●	●		●	
	ACD 503-CH-4L	25.7	0.08-0.30	5	0.3	25.7	5.0		●	●	●	●		●	
	ACD 603-CH	24	0.12-0.40	6	0.3	25	5.0		●	●	●	●		●	
ACD 804-CH	29	0.15-0.45	8	0.4	30	6.1		●	●	●	●		●		
	ACS 202-CH	-	0.05-0.20	2	0.2	20	5.1		●		●		●		
	ACS 302-CH	-	0.07-0.25	3	0.2	20	5.1		●	●	●	●	●		
	ACS 403-CH	-	0.08-0.30	4	0.3	20	5.1		●	●	●	●	●		
	ACS 503-CH	-	0.09-0.35	5	0.3	25	5.0		●	●	●	●	●		
	ACS 603-CH	-	0.12-0.40	6	0.3	25	5.0								

Remark: 1. if R/L style inserts are selected, the feed need to be reduced by 20-40%.
 2. ACS single edged insert's Tmax is determined according to the tool holder.

●: Stock available ▲: Stock available now but will be replaced in the future.

Grooving

Grooving-Turning Series

GS: Double-edged inserts applicable to external, internal and face turning, grooving and parting off

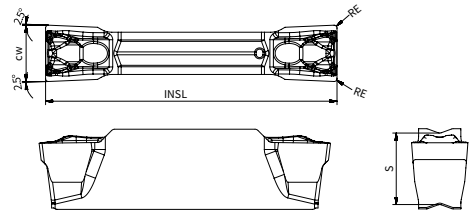

Inserts	Product code	Cutting parameter			Dimensions				Machining conditions							
									● Good condition ⬤ General condition ⬤ Bad condition							
		f (mm/rev)	f (mm/rev)	Ap (mm)	CW	RE	INSL	S	P		M		K		N	
								AC230P	AP301U	AP330M	AP301U	AP330M	AC230P	AP301U	AW100K	
	ATD 300E020-GS	0.04-0.20	0.05-0.20	0.30-2.0	3.00	0.20	20.70	5.1		●						●
	ATD 300E040-GS	0.04-0.20	0.05-0.20	0.45-2.0	3.00	0.40	20.70	5.1		●			●			●
	ATD 310E020-GS	0.04-0.20	0.05-0.20	0.25-2.0	3.15	0.20	20.70	5.1		●			●			●
	ATD 318E020-GS	0.04-0.20	0.05-0.20	0.25-2.0	3.18	0.20	20.70	5.1		●			●			●
	ATD 318E040-GS	0.04-0.20	0.05-0.20	0.45-2.0	3.18	0.40	20.70	5.1		●			●			●
	ATD 318E080-GS	0.04-0.20	0.05-0.20	0.85-2.0	3.18	0.80	20.70	5.1		●			●			●
	ATD 361E030-GS	0.04-0.20	0.06-0.23	0.35-2.0	3.61	0.30	20.70	5.1		●			●			●
	ATD 396E020-GS	0.05-0.25	0.07-0.25	0.25-2.50	3.96	0.20	20.70	5.1		●			●			●
	ATD 396E040-GS	0.05-0.25	0.07-0.25	0.45-2.50	3.96	0.40	20.70	5.1		●			●			●
	ATD 396E080-GS	0.05-0.25	0.07-0.25	0.85-2.50	3.96	0.80	20.70	5.1		●			●			●
	ATD 400E020-GS	0.05-0.25	0.07-0.25	0.25-2.50	4.00	0.20	20.70	5.1		●			●			●
	ATD 400E040-GS	0.05-0.25	0.07-0.25	0.45-2.50	4.00	0.40	20.70	5.1		●			●			●
	ATD 452E020-GS	0.06-0.28	0.10-0.30	0.25-3.0	4.52	0.20	25.70	5.0								
	ATD 470E050-GS	0.06-0.28	0.10-0.30	0.55-3.0	4.70	0.50	25.70	5.0								
	ATD 475E040-GS	0.06-0.28	0.10-0.30	0.45-3.0	4.75	0.40	25.70	5.0								
	ATD 475E080-GS	0.06-0.28	0.10-0.30	0.85-3.0	4.75	0.80	25.70	5.0								
	ATD 480E050-GS	0.06-0.28	0.10-0.30	0.55-3.0	4.80	0.50	25.70	5.0								
	ATD 500E020-GS	0.06-0.28	0.10-0.30	0.25-3.0	5.00	0.20	25.70	5.0								
	ATD 500E040-GS	0.06-0.28	0.10-0.30	0.45-3.0	5.00	0.40	25.70	5.0								
	ATD 600E020-GS	0.09-0.35	0.15-0.35	0.25-3.50	6.00	0.20	25.70	5.0								
	ATD 600E040-GS	0.09-0.35	0.15-0.35	0.45-3.50	6.00	0.40	25.70	5.0								
	ATD 635E040-GS	0.09-0.35	0.15-0.35	0.45-3.50	6.35	0.40	25.70	5.0								
	ATD 635E050-GS	0.09-0.35	0.15-0.35	0.55-3.50	6.35	0.50	25.70	5.0								
	ATD 635E080-GS	0.09-0.35	0.15-0.35	0.85-3.50	6.35	0.80	25.70	5.0								
	ATD 714E080-GS	0.09-0.35	0.18-0.40	0.85-3.50	7.14	0.80	25.70	5.0								



●: Stock available ▲: Stock available now but will be replaced in the future.

Grooving-Turning Series

TS: Double-edged inserts applicable to external, internal and face turning, grooving and parting off

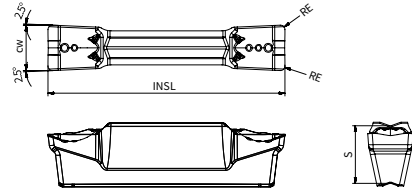

Inserts	Product code	Cutting parameter				Dimensions				Machining conditions							
		Grooving		CDX	Turning		CW	RE	INSL	S	P		M		K		N
		f (mm/rev)			f (mm/rev)	Ap (mm)					AC230P	AP301U	AP330M	AP301U	AP330M	AC230P	
	ATD 203-TS	0.04-0.20	19.7	0.12-0.19	0.40-1.50	2	0.3	20.7	5.1	●	●		●	●	●	●	
	ATD 303-TS	0.05-0.25	19.7	0.15-0.23	0.45-2.00	3	0.3	20.7	5.1		●	●	●	●		●	
	ATD 404-TS	0.06-0.27	19.7	0.18-0.25	0.50-2.50	4	0.4	20.7	5.1		●	●	●	●		●	
	ATD 408-TS	0.06-0.27	19.7	0.18-0.25	1.00-2.50	4	0.8	20.7	5.1	●	●		●	●	●	●	
	ATD 504-TS	0.07-0.30	24.7	0.20-0.30	0.55-3.50	5	0.4	25.7	5.0		●	●	●	●		●	
	ATD 508-TS	0.07-0.30	24.7	0.20-0.30	1.00-3.50	5	0.8	25.7	5.0		●	●	●	●		●	
	ATD 604-TS	0.10-0.40	24.7	0.22-0.45	0.65-3.80	6	0.4	25.7	5.0		●	●	●	●		●	
	ATD 608-TS	0.10-0.40	24.7	0.22-0.45	1.0-3.80	6	0.8	25.7	5.0	●	●	●	●	●	●	●	
	ATD 808-TS	0.12-0.45	30.5	0.28-0.50	1.0-4.50	8	0.8	31.5	6.1		●		●			●	

Grooving

Grooving-Turning Series

TM: Double-edged inserts applicable to external, internal and face turning, grooving and parting off

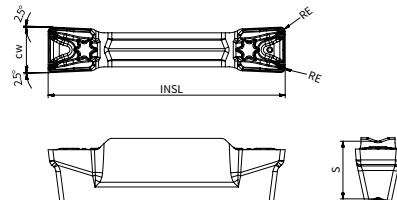

Inserts	Product code	Cutting parameter				Dimensions				Machining conditions							
		Grooving		CDX	Turning		CW	RE	INSL	S	P		M		K		N
		f (mm/rev)			f (mm/rev)	Ap (mm)					AC230P	AP301U	AP330M	AP301U	AP330M	AC230P	
	ATD 304-TM	0.1-0.25	19.7	0.15-0.22	0.5-2.0	3	0.4	20.7	5.1		●		●				
	ATD 404-TM	0.15-0.30	19.7	0.18-0.27	0.5-2.50	4	0.4	20.7	5.1	●	●	●	●	●	●	●	
	ATD 408-TM	0.15-0.30	19.7	0.18-0.27	1.0-2.50	4	0.8	20.7	5.1	●	●	●	●	●	●	●	
	ATD 504-TM	0.18-0.35	24.7	0.20-0.35	0.55-3.50	5	0.4	25.7	5.0	●	●	●	●	●	●	●	
	ATD 508-TM	0.18-0.35	24.7	0.20-0.35	1.0-3.50	5	0.8	25.7	5.0		●	●	●	●		●	
	ATD 604-TM	0.20-0.45	24.7	0.22-0.45	0.65-4.0	6	0.4	25.7	5.0	●	●	●	●	●	●	●	
	ATD 608-TM	0.20-0.45	24.7	0.22-0.45	1.0-4.0	6	0.8	25.7	5.0	●	●	●	●	●	●	●	
	ATD 808-TM	0.22-0.50	30.5	0.28-0.5	1.0-5.0	8	0.8	31.5	6.1								
	ATD 812-TM	0.22-0.50	30.5	0.28-0.5	1.5-5.0	8	1.2	31.5	6.1		●		●				

●: Stock available ▲: Stock available now but will be replaced in the future.

Grooving-Turning Series

RM: Double-edged inserts applicable to external turning, grooving and profiling

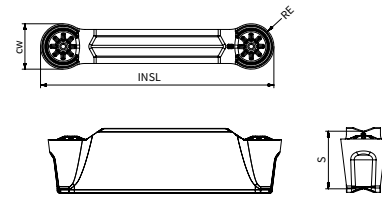

Inserts	Product code	Cutting parameter			Dimensions				Machining conditions							
									● Good condition ◐ General condition ✖ Bad condition							
		f (mm/rev)	f (mm/rev)	Ap (mm)	CW	RE	INSL	S	P		M		K		N	
	ATD 210-RM	0.06-0.15	0.12-0.25	0.4-1.0	2	1	20.7	5.1	AC230P	AP301U	AP330M	AP301U	AP330M	AC230P	AP301U	AW100K
	ATD 315-RM	0.08-0.18	0.15-0.30	0.5-1.5	3	1.5	20.7	5.1	●	●	●	●	●	●	●	
	ATD 420-RM	0.10-0.20	0.18-0.35	0.6-2.0	4	2	20.7	5.1	●	●	●	●	●	●	●	
	ATD 525-RM	0.12-0.25	0.20-0.40	0.7-2.5	5	2.5	25.7	5.0	●	●	●	●	●	●	●	
	ATD 630-RM	0.15-0.30	0.25-0.50	0.9-3.0	6	3	25.7	5.0		●	●	●	●		●	
	ATD 840-RM	0.18-0.35	0.30-0.60	1.0-4.0	8	4	31.5	6.1		●		●			●	

Grooving-Turning Series

RA: Double-edged ground inserts applicable to aluminium wheel turning and profiling

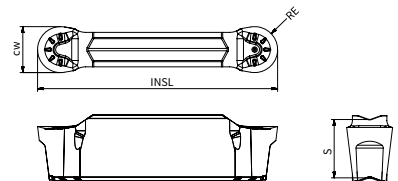

Inserts	Product code	Cutting parameter			Dimensions				Machining conditions							
									● Good condition ◐ General condition ✖ Bad condition							
		Grooving	Turning		CW	RE	INSL	S	P		M		K		N	
	ATD 315-RA	0.08-0.18	0.15-0.30	0.5-1.5	3	1.5	20.7	5.1								●
	ATD 420-RA	0.10-0.25	0.2-0.45	0.6-2.0	4	2	20.7	5.1								●
	ATD 525-RA	0.11-0.28	0.2-0.50	0.7-2.5	5	2.5	25.7	5.0								●
	ATD 630-RA	0.12-0.30	0.22-0.60	0.9-3.0	6	3	25.7	5.0								●
	ATD 840-RA	0.15-0.40	0.25-0.65	1.0-4.0	8	4	31.5	6.1								●

●: Stock available ▲: Stock available now but will be replaced in the future.

Insert Denomination System (Ground)

A 1	T 2	D 3	215 4	E 5	010 6	G 7	R/L 8
---------------	---------------	---------------	-----------------	---------------	-----------------	---------------	-----------------

1-Company Name
ACHTECK

2-Application	
C	Grooving/Parting off
T	Turning/Grooving



3-Insert Shape	
S	Single-edged
D	Double-edged

4-Insert Width
215=2.15mm
145=1.45mm

5-Application
E: External F: Facing I: Internal

6-Insert Corner
010=0.10mm 020=0.20mm 200=2.00mm

7-Application Limited	
G	only applicable to parting off

8-Hand of Tool	
	L: Left
	R: Right

Grooving

Grooving - Turning Series

Ground inserts applicable to turning and grooving

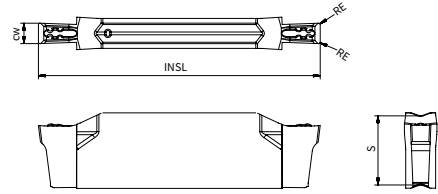

Inserts	Product code	Suitable tool holder	Cutting parameter Grooving f (mm/rev)	Dimensions					Machining conditions							
				CW	RE	CDX	S	INSL	P		M		K		N	
				AC230P	AP301U	AP330M	AP301U	AP330M	AC230P	AP301U	AW100K					
	ATD 100E000G	2mm	0.02-0.05	1.00	0.00	2.00	5.1	20.700		●		●			●	
	ATD 104E000G	2mm	0.02-0.05	1.04	0.00	2.00	5.1	20.700		●		●			●	
	ATD 115E000G	2mm	0.02-0.05	1.15	0.00	2.00	5.1	20.700		●		●			●	
	ATD 120E000G	2mm	0.03-0.05	1.20	0.00	2.00	5.1	20.700		●		●			●	
	ATD 125E010G	2mm	0.03-0.05	1.25	0.10	2.00	5.1	20.700		●		●			●	
	ATD 130E000G	2mm	0.03-0.05	1.30	0.00	2.00	5.1	20.700		●		●			●	
	ATD 135E000G	2mm	0.03-0.05	1.35	0.00	2.00	5.1	20.700		●		●			●	
	ATD 140E000G	2mm	0.03-0.06	1.40	0.00	2.00	5.1	20.700		●		●			●	
	ATD 145E010G	2mm	0.03-0.06	1.45	0.10	2.00	5.1	20.700		●		●			●	
	ATD 147E000G	2mm	0.03-0.06	1.47	0.00	2.50	5.1	20.700		●		●			●	
	ATD 150E010G	2mm	0.03-0.06	1.50	0.10	2.50	5.1	20.700		●		●			●	
	ATD 157E015G	2mm	0.03-0.07	1.57	0.15	2.70	5.1	20.700		●		●			●	
	ATD 165E010G	2mm	0.03-0.07	1.65	0.10	2.70	5.1	20.700		●		●			●	
	ATD 170E010G	2mm	0.03-0.07	1.70	0.10	3.00	5.1	20.700		●		●			●	
	ATD 178E018G	2mm	0.03-0.07	1.78	0.18	3.00	5.1	20.700		●		●			●	
	ATD 190E010G	2mm	0.04-0.09	1.90	0.10	3.00	5.1	20.700		●		●			●	
	ATD 196E015G	2mm	0.04-0.09	1.96	0.15	3.00	5.1	20.700		●		●			●	
	ATD 200E020G	2mm	0.04-0.09	2.00	0.20	3.00	5.1	20.700		●		●			●	
	ATD 215E010G	2mm	0.04-0.10	2.15	0.10	3.00	5.1	20.700		●		●			●	
	ATD 222E015G	2mm	0.04-0.10	2.22	0.15	-	5.1	20.700		●		●			●	
	ATD 230E020G	2mm	0.04-0.10	2.30	0.20	-	5.1	20.700		●		●			●	
	ATD 100E050G	2mm	0.03-0.06	1.00	0.50	2.00	5.1	20.700		●		●			●	
	ATD 140E070G	2mm	0.04-0.07	1.40	0.70	2.00	5.1	20.700		●		●			●	
	ATD 157E079G	2mm	0.04-0.08	1.57	0.78	2.70	5.1	20.700		●		●			●	
	ATD 200E100G	2mm	0.05-0.11	2.00	1.00	3.00	5.1	20.700		●		●			●	
	ATD 239E120G	2mm	0.06-0.12	2.39	1.19	-	5.1	20.700		●		●			●	

1. When the width of insert is less than 1.78mm, please pay attention to size A of the holder.

●: Stock available ▲: Stock available now but will be replaced in the future.

Grooving - Turning Series

Ground inserts applicable to turning and grooving

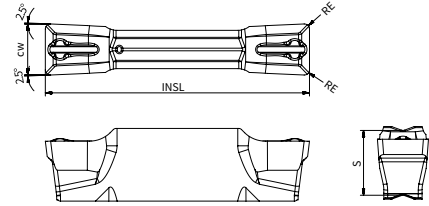

Inserts	Product code	Suitable tool holder	Cutting parameter			Dimensions					Machining conditions						
			Turning		Grooving	CW	RE	CDX	S	INSL	P		M		K		N
			f (mm/rev)	Ap (mm)	f (mm/rev)						●	●	●	●	●	●	
	ATD 265E015	3mm	0.10-0.18	0.20-1.80	0.04-0.12	2.65	0.15	-	5.1	20.70	●	●	●	●	●	●	●
	ATD 300E020	3mm	0.11-0.20	0.30-2.00	0.06-0.14	3.00	0.20	-	5.1	20.70	●	●	●	●	●	●	●
	ATD 300E040	3mm	0.15-0.23	0.50-2.20	0.06-0.15	3.00	0.40	-	5.1	20.70	●	●	●	●	●	●	●
	ATD 400E040	4mm	0.16-0.30	0.50-2.50	0.08-0.19	4.00	0.40	-	5.1	20.70	●	●	●	●	●	●	●
	ATD 400E080	4mm	0.16-0.30	1.00-2.50	0.08-0.19	4.00	0.80	-	5.1	20.70	●	●	●	●	●	●	●
	ATD 415E015	4mm	0.16-0.30	0.20-2.50	0.08-0.19	4.15	0.15	-	5.1	20.70	●	●	●	●	●	●	●
	ATD 478E055	5mm	0.20-0.35	0.60-2.60	0.10-0.20	4.78	0.55	-	5.0	25.70	●	●	●	●	●	●	●
	ATD 500E040	5mm	0.20-0.35	0.50-2.60	0.10-0.20	5.00	0.40	-	5.0	25.70	●	●	●	●	●	●	●
	ATD 500E080	5mm	0.22-0.35	1.00-3.00	0.10-0.20	5.00	0.80	-	5.0	25.70	●	●	●	●	●	●	●
	ATD 515E015	5mm	0.22-0.35	0.20-3.00	0.10-0.22	5.15	0.15	-	5.0	25.70	●	●	●	●	●	●	●
	ATD 555E055	6mm	0.23-0.40	0.60-3.00	0.12-0.28	5.55	0.55	-	5.0	25.70	●	●	●	●	●	●	●
	ATD 600E080	6mm	0.25-0.45	1.00-3.50	0.12-0.30	6.00	0.80	-	5.0	25.70	●	●	●	●	●	●	●
	ATD 600E120	6mm	0.25-0.45	1.30-3.50	0.12-0.30	6.00	1.20	-	5.0	25.70	●	●	●	●	●	●	●
	ATD 635E080	6mm	0.25-0.45	1.00-3.50	0.13-0.30	6.35	0.80	-	5.0	25.70	●	●	●	●	●	●	●
	ATD 800E080	8mm	0.30-0.55	1.00-4.80	0.15-0.40	8.00	0.80	-	6.1	31.50	●	●	●	●	●	●	●
	ATD 800E120	8mm	0.30-0.55	1.20-4.80	0.15-0.40	8.00	1.20	-	6.1	31.50	●	●	●	●	●	●	●



Grooving

●: Stock available ▲: Stock available now but will be replaced in the future.

Grooving - Turning Series

Ground inserts applicable to turning and grooving

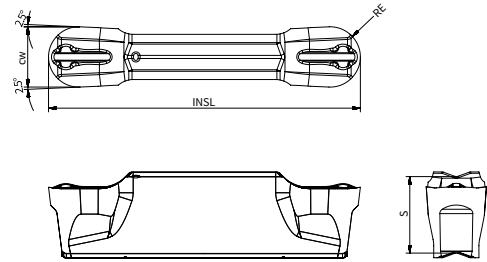

Inserts	Product code	Suitable tool holder	Cutting parameter			Dimensions					Machining conditions						
			Turning		Grooving	CW	RE	CDX	S	INSL	P		M		K		N
			f (mm/rev)	Ap (mm)	f (mm/rev)						●	●	●	●	●	●	
	ATD 300E150	3mm	0.15-0.30	0-1.50	0.08-0.19	3.00	1.50	-	5.1	20.70	●		●		●		
	ATD 400E200	4mm	0.18-0.35	0-2.00	0.10-0.20	4.00	2.00	-	5.1	20.70	●		●		●		
	ATD 478E239	5mm	0.22-0.45	0-2.40	0.12-0.24	4.78	2.39	-	5.0	25.70	●		●		●		
	ATD 500E250	5mm	0.22-0.45	0-2.50	0.12-0.24	5.00	2.50	-	5.0	25.70	●		●		●		
	ATD 600E300	6mm	0.25-0.50	0-3.00	0.15-0.30	6.00	3.00	-	5.0	25.70	●		●		●		
	ATD 800E400	8mm	0.30-0.65	0-4.00	0.18-0.35	8.00	4.00	-	6.1	31.50	●		●		●		

Blank Insert of ATBD

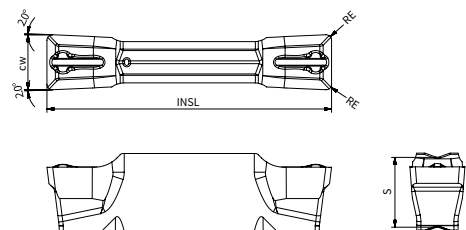

Inserts	Product code	Suitable tool holder	Dimensions				P	M	K	N	S	H
			CW	RE	INSL	S						
	ATBD 2.6 M200	2mm	2.60	0.10	21.2	5.1	●	●	●	●	●	
	ATBD 3.5 M200	3mm	3.50	0.10	21.2	5.1	●	●	●	●	●	
	ATBD 4.5 M200	4mm	4.50	0.10	21.2	5.1	●	●	●	●	●	
	ATBD 5.5 M200	5mm	5.50	0.10	26.2	5.0	●	●	●	●	●	
	ATBD 6.5 M200	6mm	6.50	0.10	26.2	5.0	●	●	●	●	●	
	ATBD 8.5 M200	8mm	8.74	0.12	32.0	6.1	●	●	●	●	●	

Finished inserts need to be used together with Achteck grooving holder.

●: Stock available ▲: Stock available now but will be replaced in the future.

Cutting Data Recommendation Table

Materials					Cutting parameter recommended table of parting off and grooving application												
ISO	Workpiece material		Brinell hardness (HB/HRC)	Tensile strength Rm(N/mm ²)	AP301U			AP330M			AC230P			AW100K			
					f (mm/rev)			f (mm/rev)			f (mm/rev)			f (mm/rev)			
					0.1	0.3	0.5	0.1	0.3	0.5	0.1	0.3	0.5	0.1	0.2	0.4	
P	Unalloyed steel	C _s ≤0.25% Annealed	125	428	180	145	130	160	130	100	220	180	160	-	-	-	
		0.25<C _s ≤0.55% Annealed	190	639	145	130	115	120	100	90	160	130	115	-	-	-	
		0.25<C _s ≤0.55% Heat-treated	210	708	130	115	100	120	100	90	130	115	100	-	-	-	
		C>0.55% Annealed	190	639	145	130	115	145	130	80	160	130	115	-	-	-	
		C>0.55% Heat-treated	300	1013	115	100	80	115	100	80	115	100	80	-	-	-	
	Free cutting steel (short-chip)	Annealed	220	745	130	115	100	130	115	100	130	115	100	-	-	-	
	Low-alloyed steel	Annealed	175	591	180	145	130	-	-	-	-	-	-	-	-	-	
		Heat-treated	300	1013	115	100	80	-	-	-	-	-	-	-	-	-	
		Heat-treated	380	1282	170	90	105	-	-	-	-	-	-	-	-	-	
		Heat-treated	430	1477	-	-	-	-	-	-	-	-	-	-	-	-	
	High-alloyed steel and high-alloyed tool steel	Annealed	200	675	-	-	-	-	-	-	-	-	-	-	-	-	
		Hardened and tempered	300	1013	-	-	-	-	-	-	-	-	-	-	-	-	
		Hardened and tempered	400	1361	-	-	-	-	-	-	-	-	-	-	-	-	
Stainless steel	Ferritic/martensitic, annealed	200	675	165	135	105	-	-	-	-	-	-	-	-	-		
	Martensitic, heat-treated	330	1114	150	115	70	-	-	-	-	-	-	-	-	-		
M	Stainless steel	Austenitic, quench hardened	200	675	165	135	105	-	-	-	-	-	-	-	-	-	
		Austenitic, precipitation hardened (PH)	300	1013	155	120	80	-	-	-	-	-	-	-	-	-	
		Austenitic/ferritic, duplex	230	778	135	110	85	-	-	-	-	-	-	-	-	-	
K	Malleable cast iron	Ferritic	200	400	115	90	65	-	-	-	115	90	65	-	-	-	
		Pearlitic	260	700	115	90	65	-	-	-	115	90	65	-	-	-	
	Grey cast iron	Low tensile strength	180	200	185	140	95	-	-	-	200	160	120	-	-	-	
		High tensile strength/austenitic	245	350	185	140	95	-	-	-	200	160	120	-	-	-	
	Nodular cast iron	Ferritic	155	400	145	110	80	-	-	-	160	130	100	-	-	-	
		Pearlitic	265	700	145	110	80	-	-	-	160	130	100	-	-	-	
GGV(CGI)		230	400	-	-	-	-	-	-	-	-	-	-	-	-		
N	Wrought aluminium alloys	Non-aging	30	-	-	-	-	-	-	-	-	-	-	-	-	-	
		Aged	100	340	-	-	-	-	-	-	-	-	-	-	-	-	
	Cast aluminium alloys	≤ 12% Si, non-aging	75	260	-	-	-	-	-	-	-	-	-	850	500	200	
		≤ 12% Si, aged	90	310	-	-	-	-	-	-	-	-	-	-	-	-	
		> 12% Si, non-aging	130	450	-	-	-	-	-	-	-	-	-	450	250	40	
	Magnesium alloys	70	250	-	-	-	-	-	-	-	-	-	-	-	-		
	Copper and copper alloys	Unalloyed, electrolytic copper	100	340	-	-	-	-	-	-	-	-	-	-	-	-	
Brass, bronze, red brass		90	310	-	-	-	-	-	-	-	-	-	-	-	-		
Cu alloys, short-chipping		110	380	-	-	-	-	-	-	-	-	-	-	-	-		
High-tensile, Ampco alloy		300	1010	-	-	-	-	-	-	-	-	-	-	-	-		
S	Heat-resistant alloys	Fe-based	Annealed	200	680	-	-	-	-	-	-	-	-	-	-	-	-
			Hardened	280	940	-	-	-	-	-	-	-	-	-	-	-	-
		Ni or Co based	Annealed	250	840	-	-	-	-	-	-	-	-	-	-	-	-
			Hardened	350	1180	-	-	-	-	-	-	-	-	-	-	-	-
	Titanium alloys	Cast	320	1080	-	-	-	-	-	-	-	-	-	-	-	-	
		Pure titanium	200	680	-	-	-	-	-	-	-	-	-	-	-	-	
α and β alloys, hardened		375	1260	-	-	-	-	-	-	-	-	-	-	-	-		
Tungsten alloys	β alloys	410	1400	-	-	-	-	-	-	-	-	-	-	-	-		
	300	1010	-	-	-	-	-	-	-	-	-	-	-	-			
Molybdenum alloys	300	1010	-	-	-	-	-	-	-	-	-	-	-	-			
	-	-	-	-	-	-	-	-	-	-	-	-	-	-			
H	Hardened steel	Hardened and tempered	50HRC	-	-	-	-	-	-	-	-	-	-	-	-	-	
		Hardened and tempered	55HRC	-	-	-	-	-	-	-	-	-	-	-	-	-	
		Hardened and tempered	60HRC	-	-	-	-	-	-	-	-	-	-	-	-	-	
	Chilled cast iron	Hardened and tempered	50HRC	-	-	-	-	-	-	-	-	-	-	-	-	-	

The recommended cutting data always refer to general cutting conditions. The actual selection should be adjusted according to machine rigidity, tool body and workpiece conditions and coolant.



ACHTECK

FM45-100-Z07-A32R-XN09-C

ACHTECK

www.achtecktool.com/en

THE EXPERT OF DIFFICULT MACHINING

CUTTING TOOL CATALOGUE

Milling Cutters	190	Milling Grade Application Recommendation Table	274
Milling Cutter Denomination System	192	Milling Grade Introduction	275
Overview of Milling Products	195	OD..06 Insert Introduction	277
AFM42-OD06 Face Milling Cutter	202	ON..05 Insert Introduction	278
AFM40-ON05 Face Milling Cutter	204	SD..09/12 Insert Introduction	279
AFM45-SD09 Face Milling Cutter	206	SE..12 Insert Introduction	280
AFM90-SD09 Face Milling Cutter	208	SN..12/19 Insert Introduction	281
AFM45-SD12 Face Milling Cutter	210	XN..07/09 Insert Introduction	285
AFM90-SD12 Face Milling Cutter	212	LNET 12 Insert Introduction	287
AFM45-SN12 Face Milling Cutter	214	ONHF/LNHQ Insert Introduction	288
AFM45-SN19 Face Milling Cutter	214	LNHU 09 Insert Introduction	289
AFM75-SN12 Face Milling Cutter	216	LNHU 13 Insert Introduction	290
AFM88-SN12 Face Milling Cutter	218	LNHU 16 Insert Introduction	291
AFM45-XN07 Face Milling Cutter	220	TDMT 15 Insert Introduction	292
AFM45-XN09 Face Milling Cutter	222	WNGU 08 Insert Introduction	293
AFM45-XN09(W) Face Milling Cutter	222	WNMU 08 Insert Introduction	294
AFM40-LN12/LN15 Cast Iron Finishing Milling Cutter	224	APKT 17 Insert Introduction	295
ASM90-LN12 Square Shoulder Milling Cutter	226	APKT 10 Insert Introduction	296
ASM90-LN09 Square Shoulder Milling Cutter	228	AOMT 12 Insert Introduction	297
ASM90-LN13 Square Shoulder Milling Cutter	230	ADMT 11 Insert Introduction	298
ASM90-LN16 Square Shoulder Milling Cutter	232	APMT 11/16 Insert Introduction	299
ASM90-WN08 Square Shoulder Milling Cutter	234	LNMX 06 Insert Introduction	300
ASM90-WN08-N Square Shoulder Milling Cutter	236	LNMX 10 Insert Introduction	301
ASM90-AP17 Square Shoulder Milling Cutter	238	XD 09/12 Insert Introduction	302
ASM90-TD15 Square Shoulder Milling Cutter	240	RPM 080/100 Insert Introduction	303
ASM90-A012 Square Shoulder Milling Cutter	242	RD/RP Insert Introduction	304
APE90-LN09 Square Shoulder Porcupine Milling Cutter	244	RO Insert Introduction	305
APE90-LN13 Square Shoulder Porcupine Milling Cutter	246	Cutting Parameter Recommendation Table	306
AHM20-LN06 High Feed Milling Cutter	248		
AHM25-LN10 High Feed Milling Cutter	250	Solid Carbide End mills	308
AHM15-XD09 High Feed Milling Cutter	252	Overview of Products	309
AHM15-XD12 High Feed Milling Cutter	254	Icon Description	310
APM00-RP080/100 Ballnose Milling Cutter	256	Denomination System	310
APM00-RO08 Profile Milling Cutter	258	ECO Line M100 General Purpose End Mills ECO Line	311
APM00-RO10 Profile Milling Cutter	260	ECO Line M105 Close Pitch End Mills ECO Line	315
APM00-RO12 Profile Milling Cutter	262	ECO Line M145 for Aluminium Alloy End Mills ECO Line	316
APM00-RO16 Profile Milling Cutter	264	PRO Line M110 General Purpose End Mills PRO Line	318
APM00-RO20 Profile Milling Cutter	266	PRO Line M115 Close Pitch End Mills PRO Line	321
		PRO Line M116 With Waved Edges End Mills PRO Line	322
		XP Line M121 High Productivity End Mills XP Line	323
		XP Line M125 Dense Tooth End Mills XP Line	325
		ECO Line Cutting Parameter	326
		PRO Line Cutting Parameter	332
		XP Line Cutting Parameter	338
Milling Inserts	268		
Milling Insert Denomination System	268		
Geometry Application Guide	271		
Geometry Introduction	272		
Milling Grade Application Description	273		

Milling Cutter Denomination System

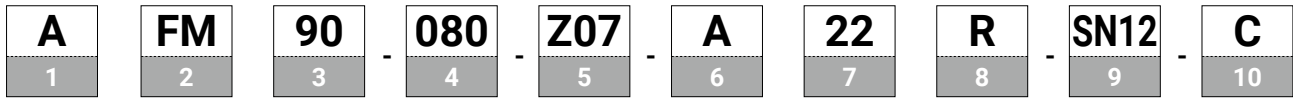

1. A--ACHTECK

2-Machining Method	
Face milling	FM
Square Shoulder milling	SM
Profile milling	PM
High feed milling	HM
Side & face milling	DM
Thread milling	TM
Chamfer milling	CM
Finish milling	FF

3-Approach Angle (Kr)	
Figure	Angle
90	90°
88	88°
75	75°
60	60°
45	45°
42	42°
*	*
15	15°
0	Round insert

4-Cutter Dia.	
025	25mm
063	63mm
080	80mm
*	*
250	250mm

5-Number of Teeth	
Z02	2 teeth
Z04	4 teeth
Z05	5 teeth
*	*
Z30	30 teeth

6-Connection Type	
A	Arbor
W	Weldon shank
C	Cylindrical shank
N	Whistle notch shank
M	Screw clamping modular head

7-Coupling Size
22--Coupling diameter 22mm

8-Direction of Tool	
R	Right
L	Left
N	Neutral

9-Insert Info
SN12--SN12 series insert

10-Others	
C	Internal coolant
M	Wedge clamping type
S	Carbide shim type
No mark	Without internal coolant

Porcupine Cutter Denomination

A	PE	90	063	Z04	A	27	R	LN13	L56	F	C
1	2	3	4	5	6	7	8	9	10	11	12

1. A--ACHTECK

2-Machining Method	
Porcupine milling cutter	PE

3-Approach Angle (Kr)	
90	90°
88	88°
75	75°
60	60°
45	45°
42	42°
*	*

4-Cutter Dia.	
025	25mm
063	63mm
080	80mm
*	*
250	250mm

5-Number of Teeth	
Z02	2 teeth
Z04	4 teeth
Z05	5 teeth
*	*
Z30	30 teeth

6-Connection Type	
A	Arbor
W	Weldon shank
C	Cylindrical shank
N	Whistle notch shank
M	Screw clamping modular head

7-Coupling Size	
27—Connection diameter 27mm	

8-Direction of Tool	
R	Right
L	Left
N	Neutral

9-Insert Info	
LN13-LN13 series insert	

10-Max. Cutting Depth	
L30	30mm
L45	45mm
L56	56mm

11-Tool Type	
F	Full teeth
H	Half teeth

12-Others	
C	Internal coolant
No mark	Without internal coolant

ACHTTECK









www.achtecktool.com/en

THE EXPERT OF DIFFICULT MACHINING



Milling Cutters









Overview of Milling Products

Product family			AFM42-OD06	AFM40-ON05	AFM45-SD09	AFM90-SD09	AFM45-SD12
Page			P202	P204	P206	P208	P210
Approach angle			42°	40°	45°	90°	45°
Max.ap (mm)			4.5	3.5	5	6	7
Diameter range (mm)			Ø50-160	Ø50-160	Ø16-125	Ø25-100	Ø50-125
Insert type			OD..0605..	ON..0504..	SD..09T3..	SD..09T3..	SD..1204..
Application	Face milling		●	●	●	●	●
	Square Shoulder milling						
	Slot milling						
	Ramping		●		●		●
	Helical interpolate milling		●				
	Plunging						
	Profile milling						
	Chamfer milling		●		●		●
	Pocket milling		●				

Remark: ● Recommended application









Milling cutters

Overview of Milling Products

Product family			AFM90-SD12	AFM45-SN12	AFM45-SN19	AFM75-SN12	AFM88-SN12
Page			P212	P214	P214	P216	P218
Approach angle			90°	45°	45°	75°	88°
Max.ap (mm)			9	6.5	11	8	10
Diameter range (mm)			Ø50-125	Ø50-315	Ø160-250	Ø50-250	Ø50-315
Insert type			SD..1204..	SN..1206..	SN..1909..	SN..1206..	SN..1206..
Application	Face milling		●	●	●	●	●
	Square Shoulder milling						
	Slot milling						
	Ramping						
	Helical interpolate milling						
	Plunging						
	Profile milling						
	Chamfer milling						
	Pocket milling						

Remark: ● Recommended application









Overview of Milling Products

Product family			AFM45-XN07	AFM45-XN09	AFM45-XN09(W)	AFF40-LN12	AFF40-LN15
Page			P220	P222	P222	P224	P224
Approach angle			45°	45°	45°	40°	40°
Max.ap (mm)			4.4	6	6	0.5	0.5
Diameter range (mm)			Ø40-250	Ø63-315	Ø80-315	Ø80-100	Ø125-250
Insert type			XN..0705..	XN..0906..	XN..0906..	ON..0504.. LN..1204..	ON..0504.. LN..1506..
Application	Face milling		●	●	●	●	●
	Square Shoulder milling						
	Slot milling						
	Ramping						
	Helical interpolate milling						
	Plunging						
	Profile milling						
	Chamfer milling						
	Pocket milling						

Remark: ● Recommended application





Milling cutters

Overview of Milling Products

Product family			ASM90-LN12	ASM90-LN09	ASM90-LN13	ASM90-LN16	ASM90-WN08
Page			P226	P228	P230	P232	P234
Approach angle			90°	90°	90°	90°	90°
Max.ap (mm)			5	8	12	15	7
Diameter range (mm)			Ø63-250	Ø20-80	Ø40-315	Ø63-160	Ø40-250
Insert type			LN..1206..	LNHU 0904..	LNHU 1306..	LNHU 160708..	WNGU 0806..
Application	Face milling		●	●	●	●	●
	Square Shoulder milling		●	●	●	●	●
	Slot milling			●	●	●	
	Ramping						
	Helical interpolate milling						
	Plunging						
	Profile milling						
	Chamfer milling						
	Pocket milling						

Remark: ● Recommended application









Overview of Milling Products

Product family			ASM90-WN08-N	ASM90-AP17	ASM90-TD15	ASM90-AO12	APE90-LN09
Page			P236	P238	P240	P242	P244
Approach angle			90°	90°	90°	90°	90°
Max.ap (mm)			7	16	11	11	48
Diameter range (mm)			Ø40-250	Ø25-100	Ø32-250	Ø20-80	Ø25-50
Insert type			WNMU 0806..	APKT 1705..	TD.T 1505..	AOMT 1204..	LNHU 0904..
Application	Face milling		●	●	●	●	●
	Square Shoulder milling		●	●	●	●	●
	Slot milling		●	●	●	●	
	Ramping			●	●	●	
	Helical interpolate milling			●	●	●	
	Plunging						
	Profile milling						
	Chamfer milling						
	Pocket milling			●	●	●	

Remark: ● Recommended application









Milling cutters

Overview of Milling Products

Product family			APE90-LN13	AHM20-LN06	AHM25-LN10	AHM15-XD09	AHM15-XD12
Page			P246	P248	P250	P252	P254
Approach angle			90°	20°	25°	15°	15°
Max.ap (mm)			56	0.65	1.2	1.5	2.5
Diameter range (mm)			Ø40-80	Ø16-63	Ø25-125	Ø25-50	Ø32-125
Insert type			LNHU 1306..	LN..0604..	LN..1005..	XD..0904..	XD..1205..
Application	Face milling		●	●	●	●	●
	Square Shoulder milling		●				
	Slot milling			●	●	●	●
	Ramping			●	●	●	●
	Helical interpolate milling			●	●	●	●
	Plunging			●	●	●	●
	Profile milling						
	Chamfer milling						
	Pocket milling			●	●	●	●

Remark: ● Recommended application

Overview of Milling Products

Product family			APM00-RP	APM00-RO08	APM00-RO10	APM00-RO12	APM00-RO16	APM00-RO20
Page			P256	P258	P260	P262	P264	P266
Approach angle			-	-	-	-	-	-
Max.ap (mm)			-	4	5	6	8	10
Diameter range (mm)			Ø16-20	Ø16-25	Ø25-50	Ø32-80	Ø63-100	Ø100-160
Insert type			RPM 080/100	RO.. 0803..	RO..10T3..	RO..1204..	RO..1605..	RO..2006..
Application	Face milling			●	●	●	●	●
	Square Shoulder milling							
	Slot milling							
	Ramping		●	●	●	●	●	●
	Helical interpolate milling			●	●	●	●	●
	Plunging							
	Profile milling		●	●	●	●	●	●
	Chamfer milling							
	Pocket milling			●	●	●	●	●

Milling cutters

Remark: ● Recommended application

AFM42-OD06

42 °Approaching angle face milling cutter

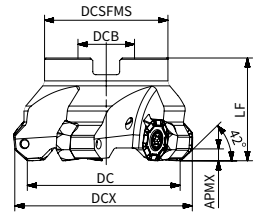
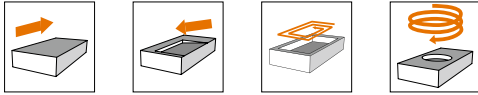

Product code	DC	DCX	DCB	DCSFMS	LF	APMX	Internal coolant	Z	Inserts
AFM42-050-Z04-A16R-OD06-C	50	60.4	16	40	40	4.5		4	OD..0605..
AFM42-063-Z05-A22R-OD06-C	63	73.4	22	48	40	4.5		5	
AFM42-080-Z05-A27R-OD06-C	80	90.4	27	62	50	4.5		5	
AFM42-080-Z06-A27R-OD06-C	80	90.4	27	62	50	4.5		6	
AFM42-100-Z06-A32R-OD06-C	100	110.4	32	80	50	4.5		6	
AFM42-100-Z07-A32R-OD06-C	100	110.4	32	80	50	4.5		7	
AFM42-125-Z07-A40R-OD06-C	125	135.4	40	87	63	4.5		7	
AFM42-125-Z08-A40R-OD06-C	125	135.4	40	87	63	4.5		8	
AFM42-160-Z10-A40R-OD06	160	170.4	40	107	63	4.5		10	

Dimension (mm)	Spare parts		
Cutter diameter	Screw	Wrench	Torque
ø50-160			5.0Nm
	SP04512043	DT-TP20	

Note: With internal coolant
 Without internal coolant

Product code	Dimension (mm)		P			M	K		N
	Corner radius	Wiper length	AP251U	AP351U	AC301P	AP403M	AC301K	AP251K	AW100K
ODET 0605APFN-FM2	0.8	1.6							●
ODMT 060508EN-MM3	0.8	-	●	▲	▲		▲	●	
ODMT 060512EN-MM3	1.2	-	●						
ODHT 0605APEN-MM3	-	1.6	●	▲			▲	●	
ODEW 0605APSR-HR2	-	1.6					▲	●	
ODMW 060512EN-HR2	1.2	-					▲	●	

●: Stock available ▲: Stock available now but will be replaced in the future.

Materials				Cutting depth and feed							
ISO	Material classification	Tensile strength (N/mm ²)	Hardness (HB)	OD..0605..							
				ap	Geometry			fz			
		HR2	MM3		FM2						
				(mm)							
				min	max	min	max	min	max	min	max
P	Unalloyed steel	<600	<180	0.20	4.50	0.15	0.40	0.12	0.35	-	-
		<950	<280			0.12	0.35	0.10	0.30	-	-
	Alloyed steel	700-950	200-280			-	-	0.08	0.28	-	-
		950-1200	280-355			0.15	0.40	0.12	0.35	-	-
1200-1400	355-415	-	-			-	-	0.10	0.35		
M	Duplex stainless steel	778	230			-	-	0.08	0.28	-	-
	Austenitic stainless steel	675	200			-	-	-	-	-	-
	Precipitation-hardening stainless steel	1013	300			-	-	-	-	-	-
K	Grey cast iron	700	220			0.15	0.40	0.12	0.35	-	-
	Nodular cast iron	880	260			-	-	-	-	-	-
	Malleable cast iron	800	250			-	-	-	-	-	-
N	Aluminum	260	75			-	-	-	-	0.10	0.35
	Aluminum alloy	447	130	-	-	-	-	-	-		
S	Fe-based alloy	943	280	-	-	-	-	-	-		
	Co-based alloy	1076	320	-	-	-	-	-	-		
	Ni-based alloy	1177	350	-	-	-	-	-	-		
	Ti-alloy	1262	370	-	-	-	-	-	-		
H	Hardened steel	-	50-60HRC	0.10	0.25	-	-	-	-		
	Chilled cast iron	-	55HRC	-	-	-	-	-	-		

*The recommended cutting conditions always refer to general conditions. These cutting conditions should be adjusted according to the practical machine rigidity, tools, workpiece clamping and coolant. Average chip thickness (hm)=fz x sinker.

Milling cutters

AFM40-ON05

40° Approaching angle face milling cutter

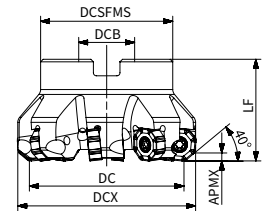

Product code	DC	DCX	DCB	DCSFMS	LF	APMX	Internal coolant	Z	Inserts
AFM40-050-Z04-A22R-ON05-N-C	50	58.8	22	47	40	3.5		4	ON..0504..
AFM40-050-Z06-A22R-ON05-N-C	50	58.8	22	47	40	3.5		6	
AFM40-063-Z05-A22R-ON05-N-C	63	71.8	22	52	40	3.5		5	
AFM40-063-Z06-A22R-ON05-N-C	63	71.8	22	52	40	3.5		6	
AFM40-063-Z08-A22R-ON05-N-C	63	71.8	22	52	40	3.5		8	
AFM40-080-Z06-A27R-ON05-N-C	80	88.8	27	62	50	3.5		6	
AFM40-080-Z08-A27R-ON05-N-C	80	88.8	27	62	50	3.5		8	
AFM40-080-Z09-A27R-ON05-N-C	80	88.8	27	62	50	3.5		9	
AFM40-100-Z07-A32R-ON05-N-C	100	108.8	32	77	50	3.5		7	
AFM40-100-Z09-A32R-ON05-N-C	100	108.8	32	77	50	3.5		9	
AFM40-100-Z11-A32R-ON05-N-C	100	108.8	32	77	50	3.5		11	
AFM40-125-Z07-A40R-ON05-N-C	125	133.8	40	90	63	3.5		7	
AFM40-125-Z09-A40R-ON05-N-C	125	133.8	40	90	63	3.5		9	
AFM40-125-Z14-A40R-ON05-N-C	125	133.8	40	90	63	3.5		14	
AFM40-160-Z10-A40R-ON05-N	160	168.8	40	107	63	3.5		10	

Dimension (mm)	Spare parts		
Cutter diameter	Screw	Wrench	Torque
ø50-160			4.0Nm
	SP040090	DT-TP15	

Note: With internal coolant
 Without internal coolant

Product code	Dimension (mm)		P			M	K		N
	Corner radius	Wiper length	AP251U	AP351U	AC301P	AP403M	AC301K	AP251K	AW100K
ONHU 050408-MM3	0.8	-	●						
ONMU 050408-MM4	0.8	-	●	▲			▲	●	
ONHU 0504ZNR-MM3	0.8	1.4	●						

●: Stock available ▲: Stock available now but will be replaced in the future.

Materials				Cutting depth and feed					
ISO	Material classification	Tensile strength (N/mm ²)	Hardness (HB)	ON..0504..					
				ap		Geometry		fz	
						MM3	MM4		
				(mm)					
				min	max	min	max	min	max
P	Unalloyed steel	<600	<180	0.20	3.50	0.10	0.25	0.15	0.35
		<950	<280						
	Alloyed steel	700-950	200-280						
		950-1200	280-355						
M	Duplex stainless steel	778	230			0.08	0.20	0.10	0.25
	Austenitic stainless steel	675	200						
	Precipitation-hardening stainless steel	1013	300						
K	Grey cast iron	700	220			0.10	0.25	0.15	0.35
	Nodular cast iron	880	260						
	Malleable cast iron	800	250						
N	Aluminum	260	75	-	-	-	-		
	Aluminum alloy	447	130						
S	Fe-based alloy	943	280	-	-	-	-		
	Co-based alloy	1076	320						
	Ni-based alloy	1177	350						
	Ti-alloy	1262	370						
H	Hardened steel	-	50-60HRC	-	-	-	-		
	Chilled cast iron	-	55HRC						

*The recommended cutting conditions always refer to general conditions. These cutting conditions should be adjusted according to the practical machine rigidity, tools, workpiece clamping and coolant. Average chip thickness (hm)=fz x sinker.

Milling cutters

AFM45-SD09

45° Approaching angle face milling cutter

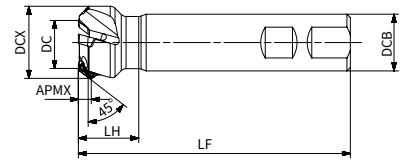
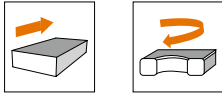

Product code	DC	DCX	DCB	LF	LH	APMX	Internal coolant	Z	Inserts
AFM45-016-Z02-W16R-SD09-C	16	25.2	16	90	25	5		2	SD..09T3..
AFM45-020-Z02-W20R-SD09-C	20	29.2	20	110	27	5		2	
AFM45-025-Z03-W25R-SD09-C	25	34	25	120	27	5		3	
AFM45-032-Z03-W32R-SD09-C	32	41	32	120	31	5		3	

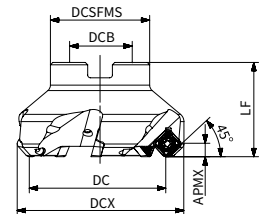

Product code	DC	DCX	DCB	DCSFMS	LF	APMX	Internal coolant	Z	Inserts
AFM45-032-Z04-A16R-SD09-C	32	41.6	16	30	40	5		4	SD..09T3..
AFM45-040-Z05-A16R-SD09-C	40	49.6	16	35	40	5		5	
AFM45-050-Z05-A22R-SD09-C	50	59.6	22	42	40	5		5	
AFM45-050-Z06-A22R-SD09-C	50	59.6	22	42	40	5		6	
AFM45-063-Z05-A22R-SD09-C	63	72.6	22	42	40	5		5	
AFM45-063-Z07-A22R-SD09-C	63	72.6	22	42	40	5		7	
AFM45-080-Z06-A27R-SD09-C	80	89.6	27	42	50	5		6	
AFM45-080-Z09-A27R-SD09-C	80	89.6	27	42	50	5		9	
AFM45-100-Z07-A32R-SD09-C	100	109.6	32	80	50	5		7	
AFM45-100-Z11-A32R-SD09-C	100	109.6	32	80	50	5		11	
AFM45-125-Z08-A40R-SD09-C	125	134.6	40	87	63	5		8	

Dimension (mm)	Spare parts		
	Screw	Wrench	Torque
Ø16-32			3.5Nm
	ST040075	DT-T15	
Ø40-125	SP040090	DT-TP15	

Note: With internal coolant
 Without internal coolant

Product code	Dimension (mm)		P			M	K		N
	Corner radius	Wiper length	AP251U	AP351U	AC301P	AP403M	AC301K	AP251K	AW100K
SDMT 09T304EN-MM3	0.4	-	●	▲	▲		▲		
SDMT 09T308EN-MM3	0.8	-	●	▲			▲		
SDGT 09T3PDER-MR6	0.8	1.2	●	▲				●	

● : Stock available ▲ : Stock available now but will be replaced in the future.

Materials				Cutting depth and feed					
ISO	Material classification	Tensile strength (N/mm ²)	Hardness (HB)	SD..09T3..					
				ap		MM3			
						(mm)			
				min	max	min	max		
P	Unalloyed steel	<600	<180	0.20	5.00	0.08	0.30		
		<950	<280						
	Alloyed steel	700-950	200-280			0.05	0.28		
		950-1200	280-355						
		1200-1400	355-415						
M	Duplex stainless steel	778	230			0.05	0.25		
	Austenitic stainless steel	675	200						
	Precipitation-hardening stainless steel	1013	300						
K	Grey cast iron	700	220			0.08	0.30		
	Nodular cast iron	880	260						
	Malleable cast iron	800	250						
N	Aluminum	260	75	-	-				
	Aluminum alloy	447	130						
S	Fe-based alloy	943	280	-	-				
	Co-based alloy	1076	320						
	Ni-based alloy	1177	350						
	Ti-alloy	1262	370						
H	Hardened steel	-	50-60HRC	-	-				
	Chilled cast iron	-	55HRC						

*The recommended cutting conditions always refer to general conditions. These cutting conditions should be adjusted according to the practical machine rigidity, tools, workpiece clamping and coolant. Average chip thickness (hm)=fz x sinker.

Milling cutters

AFM90-SD09

90° Approach angle face milling cutter

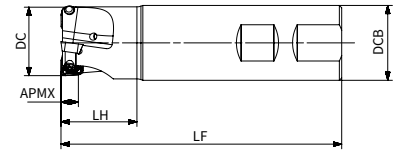

Product code	DC	DCB	LF	LH	APMX	Internal coolant	Z	Inserts
AFM90-025-Z02-W25R-SD09-C	25	25	120	27.7	6		2	SD..09T3..
AFM90-032-Z03-W32R-SD09-C	32	32	120	32.5	6		3	

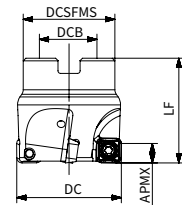
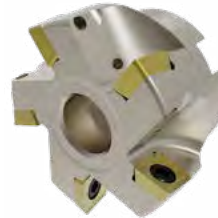

Product code	DC	DCB	DCSFMS	LF	APMX	Internal coolant	Z	Inserts
AFM90-040-Z04-A16R-SD09-C	40	16	35	40	6		4	SD..09T3..
AFM90-050-Z05-A22R-SD09-C	50	22	42	40	6		5	
AFM90-063-Z06-A22R-SD09-C	63	22	48	40	6		6	
AFM90-080-Z08-A27R-SD09-C	80	27	52	50	6		8	
AFM90-100-Z10-A32R-SD09-C	100	32	80	50	6		10	

Dimension (mm)	Spare parts		
	Screw	Wrench	Torque
ø25-32			3.5Nm
	ST040075	DT-T15	
ø40-100	SP040090	DT-TP15	

Note: With internal coolant
 Without internal coolant

Product code	Dimension (mm)		P			M	K		N
	Corner radius	Wiper length	AP251U	AP351U	AC301P	AP403M	AC301K	AP251K	AW100K
SDMT 09T304EN-MM3	0.4	-	●	▲	▲		▲		
SDMT 09T308EN-MM3	0.8	-	●	▲			▲		
SDGT 09T3PDER-MR6	0.8	1.2	●	▲				●	

●: Stock available ▲: Stock available now but will be replaced in the future.

Materials				Cutting depth and feed									
ISO	Material classification	Tensile strength (N/mm ²)	Hardness (HB)	SD..09T3..									
				ap	Geometry		fz		(mm)				
		MR6	MM3				min	max					
				min	max	min	max	min	max				
P	Unalloyed steel	<600	<180	0.20	6.00	0.10	0.35	0.08	0.30				
		<950	<280										
	Alloyed steel	700-950	200-280							0.08	0.30	0.05	0.28
		950-1200	280-355										
		1200-1400	355-415										
M	Duplex stainless steel	778	230					-	-	0.05	0.25		
	Austenitic stainless steel	675	200										
	Precipitation-hardening stainless steel	1013	300										
K	Grey cast iron	700	220					0.10	0.35	0.08	0.30		
	Nodular cast iron	880	260										
	Malleable cast iron	800	250										
N	Aluminum	260	75					-	-	-	-		
	Aluminum alloy	447	130										
S	Fe-based alloy	943	280										
	Co-based alloy	1076	320										
	Ni-based alloy	1177	350										
	Ti-alloy	1262	370										
H	Hardened steel	-	50-60HRC			0.06	0.20	-	-				
	Chilled cast iron	-	55HRC										

*The recommended cutting conditions always refer to general conditions. These cutting conditions should be adjusted according to the practical machine rigidity, tools, workpiece clamping and coolant. Average chip thickness (hm)=fz x sinker.

Milling cutters

AFM45-SD12

45° Approaching angle face milling cutter

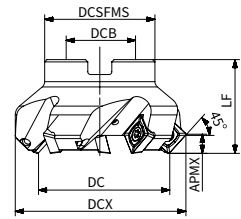
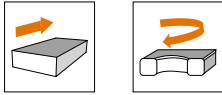

Product code	DC	DCX	DCB	DCSFMS	LF	APMX	Internal coolant	Z	Inserts
AFM45-050-Z04-A22R-SD12-C	50	62.7	22	42	40	7		4	SD..1204..
AFM45-063-Z05-A22R-SD12-C	63	75.7	22	48	40	7		5	
AFM45-080-Z06-A27R-SD12-C	80	92.7	27	52	50	7		6	
AFM45-100-Z07-A32R-SD12-C	100	112.7	32	80	50	7		7	
AFM45-125-Z08-A40R-SD12-C	125	137.7	40	87	63	7		8	

Dimension (mm)	Spare parts		
Cutter diameter	Screw	Wrench	Torque
ø50-125			5.0Nm
	SP04511555	DT-TP20	

Note: With internal coolant
 Without internal coolant

Product code	Dimension (mm)		P			M	K		N
	Corner radius	Wiper length	AP251U	AP351U	AC301P	AP403M	AC301K	AP251K	AW100K
SDMT 120408EN-MM4	0.8	-	●	▲			▲		
SDMT 120412EN-MM3	1.2	-	●		▲		▲		
SDKT 1204AEEN-MR2	-	1.5		▲				●	

● : Stock available ▲ : Stock available now but will be replaced in the future.

Materials				Cutting depth and feed									
ISO	Material classification	Tensile strength (N/mm ²)	Hardness (HB)	SD..1204..									
				ap	MR2		MM4		MM3				
(mm)													
		min	max	min	max	min	max	min	max				
P	Unalloyed steel	<600	<180	0.20	7.00	0.15	0.30	0.15	0.30	0.12	0.28		
		<950	<280										
	Alloyed steel	700-950	200-280			0.15	0.25	0.15	0.25	0.10	0.25		
		950-1200	280-355										
	1200-1400	355-415											
M	Duplex stainless steel	778	230					0.12	0.25	0.10	0.25	0.08	0.20
	Austenitic stainless steel	675	200										
	Precipitation-hardening stainless steel	1013	300										
K	Grey cast iron	700	220					0.10	0.22	0.10	0.25	0.12	0.28
	Nodular cast iron	880	260										
	Malleable cast iron	800	250										
N	Aluminum	260	75					-	-	-	-	-	-
	Aluminum alloy	447	130										
S	Fe-based alloy	943	280										
	Co-based alloy	1076	320						0.08	0.20			
	Ni-based alloy	1177	350										
	Ti-alloy	1262	370										
H	Hardened steel	-	50-60HRC			-	-	-	-	-	-		
	Chilled cast iron	-	55HRC										

*The recommended cutting conditions always refer to general conditions. These cutting conditions should be adjusted according to the practical machine rigidity, tools, workpiece clamping and coolant. Average chip thickness (hm)=fz x sinker.

Milling cutters

AFM90-SD12

90° Approach angle face milling cutter

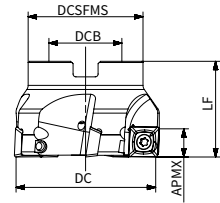
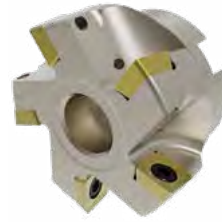

Product code	DC	DCB	DCSFMS	LF	APMX	Internal coolant	Z	Inserts
AFM90-050-Z04-A22R-SD12-C	50	22	42	40	9		4	SD..1204..
AFM90-063-Z05-A22R-SD12-C	63	22	48	40	9		5	
AFM90-080-Z06-A27R-SD12-C	80	27	52	50	9		6	
AFM90-100-Z08-A32R-SD12-C	100	32	80	50	9		8	
AFM90-125-Z10-A40R-SD12-C	125	40	87	63	9		10	

Dimension (mm)	Spare parts		
Cutter diameter	Screw	Wrench	Torque
ø50-125			5.0Nm
	SP04511555	DT-TP20	

Note: With internal coolant
 Without internal coolant

Product code	Dimension (mm)		P			M	K		N
	Corner radius	Wiper length	AP251U	AP351U	AC301P	AP403M	AC301K	AP251K	AW100K
SDMT 120408EN-MM4	0.8	-	●	▲		●	▲		
SDMT 120412EN-MM3	1.2	-	●		▲		▲		
SDKT 1204AEEN-MR2	-	1.5		▲				●	

●: Stock available ▲: Stock available now but will be replaced in the future.

Materials				Cutting depth and feed									
ISO	Material classification	Tensile strength (N/mm ²)	Hardness (HB)	SD..1204..									
				ap		Geometry		fz					
		MM4	MM3										
				(mm)									
				min	max	min	max	min	max				
P	Unalloyed steel	<600	<180	0.20	9.00	0.15	0.30	0.12	0.30				
		<950	<280										
	Alloyed steel	700-950	200-280							0.15	0.25	0.10	0.25
		950-1200	280-355										
		1200-1400	355-415										
M	Duplex stainless steel	778	230					0.10	0.25	0.10	0.22		
	Austenitic stainless steel	675	200										
	Precipitation-hardening stainless steel	1013	300										
K	Grey cast iron	700	220					0.10	0.25	0.12	0.30		
	Nodular cast iron	880	260										
	Malleable cast iron	800	250										
N	Aluminum	260	75					-	-	-	-		
	Aluminum alloy	447	130										
S	Fe-based alloy	943	280										
	Co-based alloy	1076	320					0.10	0.20				
	Ni-based alloy	1177	350										
	Ti-alloy	1262	370										
H	Hardened steel	-	50-60HRC			0.08	0.25	-	-				
	Chilled cast iron	-	55HRC										

*The recommended cutting conditions always refer to general conditions. These cutting conditions should be adjusted according to the practical machine rigidity, tools, workpiece clamping and coolant. Average chip thickness (hm)=fz x sinkr.

Milling cutters

AFM45-SN12/SN19

45° Approaching angle face milling cutter

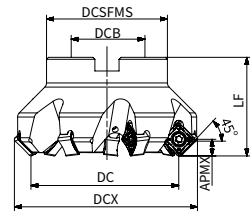

Product code	DC	DCX	DCB	DCSFMS	LF	APMX	Internal coolant	Z	Inserts
AFM45-050-Z04-A22R-SN12-N-C	50	63.9	22	47	40	6.5		4	SN..1206ANN.. SN..1206..
AFM45-050-Z06-A22R-SN12-N-C	50	63.9	22	47	40	6.5		6	
AFM45-063-Z04-A22R-SN12-N-C	63	76.9	22	52	40	6.5		4	
AFM45-063-Z06-A22R-SN12-N-C	63	76.9	22	52	40	6.5		6	
AFM45-063-Z08-A22R-SN12-N-C	63	76.9	22	52	40	6.5		8	
AFM45-080-Z04-A27R-SN12-N-C	80	93.9	27	62	50	6.5		4	
AFM45-080-Z05-A27R-SN12-N-C	80	93.9	27	62	50	6.5		5	
AFM45-080-Z07-A27R-SN12-N-C	80	93.9	27	62	50	6.5		7	
AFM45-100-Z06-A32R-SN12-N-C	100	113.9	32	77	50	6.5		6	
AFM45-100-Z08-A32R-SN12-N-C	100	113.9	32	77	50	6.5		8	
AFM45-125-Z07-A40R-SN12-N-C	125	138.9	40	90	63	6.5		7	
AFM45-125-Z08-A40R-SN12-N-C	125	138.9	40	90	63	6.5		8	
AFM45-125-Z10-A40R-SN12-N-C	125	138.9	40	90	63	6.5		10	
AFM45-160-Z10-A40R-SN12-N	160	173.9	40	107	63	6.5		10	
AFM45-200-Z14-A60R-SN12-N	200	213.9	60	130	63	6.5		14	
AFM45-250-Z16-A60R-SN12-N	250	263.9	60	180	63	6.5		16	
AFM45-315-Z14-A60R-SN12-M	315	328.5	60	220	63	6.5		14	
AFM45-160-Z08-A40R-SN19	160	181.3	40	107	63	11		8	SN..1909ANN..
AFM45-200-Z10-A60R-SN19	200	221.3	60	130	63	11		10	
AFM45-250-Z12-A60R-SN19	250	271.3	60	180	63	11		12	

Dimension (mm)	Spare parts		
Cutter diameter	Screw	Wrench	Torque
ø50-315(SN..1206ANN)			3.5Nm
	SP050120	DT-TP20	
ø160-250(SN..1909ANN)	SP06018070	DT-TP25	5.0Nm

Cartridge	Cartridge screw	Cartridge screw wrench	Wedge	Wedge screw	Wedge screw wrench
C-SN1242-62-45	ACH622	LT-H5	AWG-6H-6	AWCH624	LT-H3

Note: With internal coolant
 Without internal coolant

Product code	Dimension (mm)		P			M	K		N
	Corner radius	Wiper length	AP25TU	AP35TU	AC301P	AP403M	AC301K	AP25TK	AW100K
SNGX 1206ANN-MM3	0.4	1.8	●	▲	▲		▲	●	
SNGX 1206ANN-MM4	0.4	1.8	●	▲	▲	●	▲	●	
SNGX 1206ANN-MR6	0.4	1.8	●	▲	▲		▲	●	
SNGX 1206ANN-RR2	0.5	1.8	●	▲	▲		▲	●	
SNGX 1909ANN-MM3	0.4	2.9		▲					
SNGX 1909ANN-MR6	0.8	2.9		▲					
SNGX 120608-MM4	0.8	-	●	▲	▲		▲	●	
SNGX 120612-MM4	1.2	-	●						
SNMX 1206ANN-MM3	0.4	1.8	●	▲	▲		▲	●	
SNMX 1206ANN-MM4	0.4	1.8	●	▲	▲	●	▲	●	
SNMX 1206ANN-MR6	0.4	1.8	●	▲	▲		▲	●	
SNMX 120608-MM4	0.8	-	●	▲	▲		▲	●	
SNMX 120612-MM3	1.2	-	●	▲	▲		▲	●	
SNMX 120612-MM4	1.2	-	●	▲	▲		▲	●	
SNMX 120612R-MM4	1.2	-	●	▲	▲	●	▲	●	
SNMX 120612-MR6	1.2	-	●	▲	▲		▲	●	
SNMX 120612-RR2	1.2	-	●	▲	▲		▲	●	
SNMX 120620-MM4	2.0	-	●	▲	▲		▲	●	
SNMX 120620-RR2	2.0	-	●	▲	▲		▲	●	
SNHX 1206ANN-FM2	0.5	1.8							●
SNHX 1206ANN-W	1.2	6.7	●				▲		

●: Stock available ▲: Stock available now but will be replaced in the future.

Materials				Cutting depth and feed														
ISO	Material classification	Tensile strength (N/mm ²)	Hardness (HB)	SN.. 1206..														
				ap	Geometry					fz								
					MM3		MM4		MR6		RR2		FM2					
					(mm)													
min	max	min	max	min	max	min	max	min	max	min	max							
P	Unalloyed steel	<600	<180	0.20	6.50	0.15	0.35	0.18	0.38	0.18	0.40	0.18	0.45	-	-			
		<950	<280			-	-	-	-	-	-	-	-	-				
	Alloyed steel	700-950	200-280			0.12	0.32	0.15	0.35	0.15	0.38	0.15	0.38	-	-			
		950-1200	280-355			-	-	-	-	-	-	-	-	-	-			
1200-1400	355-415	-	-			-	-	-	-	-	-	-	-					
M	Duplex stainless steel	778	230			-	-	-	-	-	-	-	-	-	-			
	Austenitic stainless steel	675	200			0.12	0.30	0.12	0.32	-	-	-	-	-	-			
	Precipitation-hardening stainless steel	1013	300			-	-	-	-	-	-	-	-	-	-			
K	Grey cast iron	700	220			0.20	6.50	0.15	0.35	0.18	0.38	0.18	0.40	0.18	0.45	-	-	
	Nodular cast iron	880	260					-	-	-	-	-	-	-	-	-		
	Malleable cast iron	800	250					-	-	-	-	-	-	-	-	-		
N	Aluminum	260	75					-	-	-	-	-	-	-	-	-	0.15	0.35
	Aluminum alloy	447	130	-	-			-	-	-	-	-	-	-	-	-		
S	Fe-based alloy	943	280	0.20	6.50			0.10	0.25	0.12	0.28	-	-	-	-	-	-	
	Co-based alloy	1076	320					-	-	-	-	-	-	-	-	-		
	Ni-based alloy	1177	350					-	-	-	-	-	-	-	-	-		
	Ti-alloy	1262	370					-	-	-	-	-	-	-	-	-		
H	Hardened steel	-	50-60HRC					-	-	-	-	-	-	-	-	-	-	-
	Chilled cast iron	-	55HRC					-	-	-	-	-	-	-	-	-	-	-

*The recommended cutting conditions always refer to general conditions. These cutting conditions should be adjusted according to the practical machine rigidity, tools, workpiece clamping and coolant. Average chip thickness (hm)=fz x sinkr.

Milling cutters

AFM75-SN12

75° Approaching angle face milling cutter

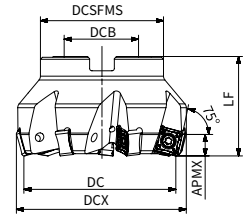

Product code	DC	DCX	DCB	DCSFMS	LF	APMX	Internal coolant	Z	Inserts
AFM75-050-Z04-A22R-SN12-N-C	50	56.4	22	42	40	8		4	SN..1206ENN.. SN..1206..
AFM75-063-Z06-A22R-SN12-N-C	63	69.4	22	52	40	8		6	
AFM75-080-Z07-A27R-SN12-N-C	80	86.4	27	62	50	8		7	
AFM75-100-Z08-A32R-SN12-N-C	100	106.4	32	67	50	8		8	
AFM75-125-Z08-A40R-SN12-N-C	125	131.4	40	90	63	8		8	
AFM75-125-Z10-A40R-SN12-N-C	125	131.4	40	90	63	8		10	
AFM75-160-Z10-A40R-SN12-N	160	166.4	40	107	63	8		10	
AFM75-200-Z14-A60R-SN12-N	200	206.4	60	130	63	8		14	
AFM75-250-Z16-A60R-SN12-N	250	256.4	60	180	63	8		16	

Dimension (mm)	Spare parts		
Cutter diameter	Screw	Wrench	Torque
ø50-250			3.5Nm
	SP050120	DT-TP20	

Note: With internal coolant
 Without internal coolant

Product code	Dimension (mm)		P			M	K		N
	Corner radius	Wiper length	AP251U	AP351U	AC301P	AP403M	AC301K	AP251K	AW100K
SNGX 1206ENN-MM3	0.8	1.2	●	▲	▲		▲	●	
SNGX 1206ENN-MM4	0.8	1.2	●	▲	▲		▲	●	
SNGX 1206ENN-MR6	0.8	1.2	●	▲	▲		▲	●	
SNGX 120608-MM4	0.8	-	●	▲	▲		▲	●	
SNGX 120612-MM4	1.2	-	●						
SNMX 1206ENN-MM4	0.8	1.2			▲			●	
SNMX 120608-MM4	0.8	-	●	▲	▲		▲	●	
SNMX 120612-MM3	1.2	-	●	▲	▲		▲	●	
SNMX 120612-MM4	1.2	-	●	▲	▲		▲	●	
SNMX 120612R-MM4	1.2	-	●	▲	▲	●	▲	●	
SNMX 120612-MR6	1.2	-	●	▲	▲		▲	●	
SNMX 120612-RR2	1.2	-	●	▲	▲		▲	●	
SNMX 120620-MM4	2.0	-	●	▲	▲		▲	●	
SNMX 120620-RR2	2.0	-	●	▲	▲		▲	●	
SNHX 1206ENN-W	0.6	1.2	●				▲		

●: Stock available ▲: Stock available now but will be replaced in the future.

Materials				Cutting depth and feed										
ISO	Material classification	Tensile strength (N/mm ²)	Hardness (HB)	SN..1206..										
				ap	Geometry				fz					
					MM3		MM4		MR6		RR2			
				(mm)										
min	max	min	max	min	max	min	max	min	max	min	max			
P	Unalloyed steel	<600	<180	0.20	8.00	0.12	0.32	0.19	0.35	0.15	0.38	0.18	0.40	
		<950	<280											
	Alloyed steel	700-950	200-280			0.10	0.30	0.12	0.32	0.10	0.35	0.15	0.35	
		950-1200	280-355											
1200-1400	355-415													
M	Duplex stainless steel	778	230											
	Austenitic stainless steel	675	200			0.10	0.28	0.10	0.30	-	-	-	-	
	Precipitation-hardening stainless steel	1013	300											
K	Grey cast iron	700	220											
	Nodular cast iron	880	260	0.12	0.32	0.15	0.35	0.12	0.35	0.18	0.40			
	Malleable cast iron	800	250											
N	Aluminum	260	75											
	Aluminum alloy	447	130	-	-	-	-	-	-	-	-			
S	Fe-based alloy	943	280											
	Co-based alloy	1076	320											
	Ni-based alloy	1177	350	0.10	0.22	0.10	0.25	-	-	-	-			
	Ti-alloy	1262	370											
H	Hardened steel	-	50-60HRC											
	Chilled cast iron	-	55HRC											

*The recommended cutting conditions always refer to general conditions. These cutting conditions should be adjusted according to the practical machine rigidity, tools, workpiece clamping and coolant. Average chip thickness (hm)=fz x sinker.

Milling cutters

AFM88-SN12

88° Approaching angle face milling cutter

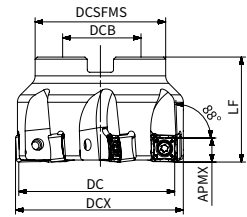
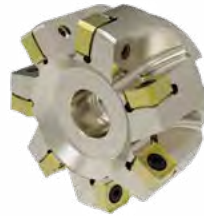

Product code	DC	DCX	DCB	DCSFMS	LF	APMX	Internal coolant	Z	Inserts
AFM88-050-Z04-A22R-SN12-N-C	50	51.2	22	42	40	10		4	SN..1206ZNN.. SN..1206..
AFM88-063-Z04-A22R-SN12-N-C	63	64.2	22	52	40	10		4	
AFM88-063-Z06-A22R-SN12-N-C	63	64.2	22	62	40	10		6	
AFM88-080-Z04-A27R-SN12-N-C	80	81.2	27	62	50	10		4	
AFM88-080-Z07-A27R-SN12-N-C	80	81.2	27	62	50	10		7	
AFM88-100-Z08-A32R-SN12-N-C	100	101.2	32	77	50	10		8	
AFM88-100-Z11-A32R-SN12-N-C	100	101.2	32	77	50	10		11	
AFM88-125-Z10-A40R-SN12-N-C	125	126.2	40	90	63	10		10	
AFM88-125-Z13-A40R-SN12-N-C	125	126.2	40	90	63	10		13	
AFM88-160-Z12-A40R-SN12-N	160	161.2	40	108	63	10		12	
AFM88-200-Z14-A60R-SN12-N	200	201.2	60	130	63	10		14	
AFM88-250-Z12-A60R-SN12-M	250	250.9	60	180	63	10		12	
AFM88-315-Z14-A60R-SN12-M	315	315.9	60	220	63	10		14	

Dimension (mm)	Spare parts		
Cutter diameter	Screw	Wrench	Torque
ø50-315			3.5Nm
	SP050120	DT-TP20	

Cartridge	Cartridge screw	Cartridge screw wrench	Wedge	Wedge screw	Wedge screw wrench
C-SN1242-62-88	ACH622	LT-H5	AWG-6H-6	AWCH624	LT-H3

Note: With internal coolant
 Without internal coolant

Product code	Dimension (mm)		P			M	K		N
	Corner radius	Wiper length	AP251U	AP351U	AC301P	AP403M	AC301K	AP251K	AW100K
SNGX 1206ZNN-MM3	0.8	1.2	●	▲	▲		▲	●	
SNGX 1206ZNN-MM4	0.8	1.2	●	▲	▲	●	▲	●	
SNGX 1206ZNN-MR6	0.8	1.2	●	▲	▲		▲	●	
SNGX 120608-MM4	0.8	-	●	▲	▲		▲	●	
SNGX 120612-MM4	1.2	-	●						
SNMX 120608-MM4	0.8	-	●	▲	▲		▲	●	
SNMX 120612-MM3	1.2	-	●	▲	▲		▲	●	
SNMX 120612-MM4	1.2	-	●	▲	▲		▲	●	
SNMX 120612R-MM4	1.2	-	●	▲	▲	●	▲	●	
SNMX 120612-MR6	1.2	-	●	▲	▲		▲	●	
SNMX 120612-RR2	1.2	-	●	▲	▲		▲	●	
SNMX 120620-MM4	2.0	-	●	▲	▲		▲	●	
SNMX 120620-RR2	2.0	-	●	▲	▲		▲	●	
SNHX 1206ZNN-FM2	0.8	1.2							●
SNHX 1206ZNN-W	1.0	4.4	●				▲		

●: Stock available ▲: Stock available now but will be replaced in the future.

Materials				Cutting depth and feed													
ISO	Material classification	Tensile strength (N/mm ²)	Hardness (HB)	SN.. 1206..													
				ap	Geometry					fz							
					(mm)												
				min	max	min	max	min	max	min	max	min	max	min	max		
P	Unalloyed steel	<600	<180	0.20	10.00	0.12	0.32	0.19	0.35	0.15	0.38	0.18	0.40	-	-		
		<950	<280														
	Alloyed steel	700-950	200-280			0.10	0.30	0.12	0.32	0.10	0.35	0.15	0.35	-	-		
		950-1200	280-355														
	1200-1400	355-415															
M	Duplex stainless steel	778	230					0.10	0.28	0.10	0.30	-	-	-	-	-	
	Austenitic stainless steel	675	200														
	Precipitation-hardening stainless steel	1013	300														
K	Grey cast iron	700	220					0.12	0.32	0.15	0.35	0.12	0.35	0.18	0.40	-	-
	Nodular cast iron	880	260														
	Malleable cast iron	800	250														
N	Aluminum	260	75					-	-	-	-	-	-	-	0.12	0.32	
	Aluminum alloy	447	130														
S	Fe-based alloy	943	280														
	Co-based alloy	1076	320			0.10	0.22	0.10	0.25	-	-	-	-	-			
	Ni-based alloy	1177	350														
	Ti-alloy	1262	370														
H	Hardened steel	-	50-60HRC			-	-	-	-	-	-	-	-	-			
	Chilled cast iron	-	55HRC														

*The recommended cutting conditions always refer to general conditions. These cutting conditions should be adjusted according to the practical machine rigidity, tools, workpiece clamping and coolant. Average chip thickness (hm)=fz x sinker.

Milling cutters

AFM45-XN07

45° Approaching angle face milling cutter

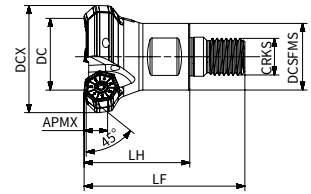

Product code	DC	DCX	CRKS	DCSFMS	LF	LH	APMX	Internal coolant	Z	Inserts
AFM45-040-Z03-M16R-XN07-C	40	49.3	M16	29	70	43	4.4		3	XN..0705..

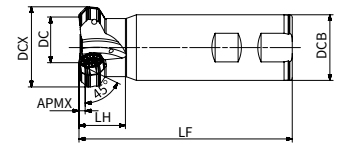



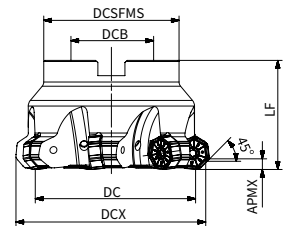

Product code	DC	DCX	DCB	LF	LH	APMX	Internal coolant	Z	Inserts
AFM45-040-Z03-W40R-XN07-C	40	49.8	40	130	28.3	4.4		3	XN..0705..

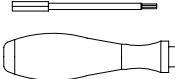

Product code	DC	DCX	DCB	DCSFMS	LF	APMX	Internal coolant	Z	Inserts
AFM45-040-Z03-A16R-XN07-C	40	49.7	16	35	40	4.4		3	XN..0705..
AFM45-050-Z04-A22R-XN07-C	50	59.7	22	42	40	4.4		4	
AFM45-050-Z05-A22R-XN07-C	50	59.7	22	42	40	4.4		5	
AFM45-063-Z05-A22R-XN07-C	63	72.7	22	48	40	4.4		5	
AFM45-063-Z06-A22R-XN07-C	63	72.7	22	48	40	4.4		6	
AFM45-080-Z06-A27R-XN07-C	80	89.7	27	62	50	4.4		6	
AFM45-080-Z07-A27R-XN07-C	80	89.7	27	62	50	4.4		7	
AFM45-100-Z07-A32R-XN07-C	100	109.7	32	77	50	4.4		7	
AFM45-100-Z08-A32R-XN07-C	100	109.7	32	77	50	4.4		8	
AFM45-125-Z08-A40R-XN07-C	125	134.7	40	87	63	4.4		8	
AFM45-125-Z10-A40R-XN07-C	125	134.7	40	87	63	4.4		10	
AFM45-160-Z09-A40R-XN07	160	169.7	40	107	63	4.4		9	
AFM45-160-Z12-A40R-XN07	160	169.7	40	107	63	4.4		12	
AFM45-200-Z14-A60R-XN07	200	209.3	60	130	63	4.4		14	
AFM45-250-Z14-A60R-XN07-S	250	259.6	60	180	63	4.4		14	

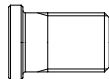
Note: With internal coolant
 Without internal coolant

Dimension (mm)	Spare parts					Torque
Cutter diameter	Screw	Wrench	Shim	Shim screw	Shim screw wrench	
ø40-250						3.5Nm
	SP035120H	DT-TP15	S-XN07030	SS050085F	LT-H3.5	

Product code	Dimension (mm)		P			M	K		N
	corner radius	Wiper length	AP25TU	AP35TU	AC301P	AP403M	AC301K	AP251K	AW100K
XNGU 0705ANN-MM3	0.8	1.1	●	▲			▲		
XNGU 0705ANN-MM4	0.8	1.1	●				▲		
XNMU 0705ANN-MM4	0.8	1.1	●	▲	▲		▲	●	
XNMU 0705ANN-MR6	0.8	1.1	●	▲			▲	●	
XNMU 070508-MM4	0.8	-	●	▲		●	▲	●	
XNGX 0705ANN-W	1.0	6	●				▲		

● : Stock available ▲ : Stock available now but will be replaced in the future.

Materials				Cutting depth and feed							
ISO	Material classification	Tensile strength (N/mm ²)	Hardness (HB)	XN.. 0705..							
				ap	Geometry			fz			
					MM3	MM4	MR6				
				(mm)							
min	max	min	max	min	max	min	max				
P	Unalloyed steel	<600	<180	0.20	4.40	0.15	0.35	0.18	0.38	0.18	0.40
		<950	<280								
	Alloyed steel	700-950	200-280			0.12	0.32	0.15	0.35	0.15	0.38
		950-1200	280-355								
	1200-1400	355-415									
M	Duplex stainless steel	778	230								
	Austenitic stainless steel	675	200			0.12	0.30	0.12	0.32	-	-
	Precipitation-hardening stainless steel	1013	300								
K	Grey cast iron	700	220								
	Nodular cast iron	880	260			0.15	0.35	0.18	0.38	0.18	0.40
	Malleable cast iron	800	250								
N	Aluminum	260	75								
	Aluminum alloy	447	130	-	-	-	-	-	-		
S	Fe-based alloy	943	280								
	Co-based alloy	1076	320	0.10	0.25	0.12	0.28	-	-		
	Ni-based alloy	1177	350								
	Ti-alloy	1262	370								
H	Hardened steel	-	50-60HRC								
	Chilled cast iron	-	55HRC								

*The recommended cutting conditions always refer to general conditions. These cutting conditions should be adjusted according to the practical machine rigidity, tools, workpiece clamping and coolant. Average chip thickness (hm)=fz x sinker.

AFM45-XN09

45° Approaching angle face milling cutter

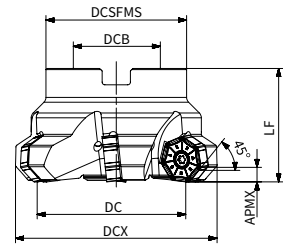

Product code	DC	DCX	DCB	DCSFMS	LF	APMX	Internal coolant	Z	Inserts
AFM45-063-Z05-A22R-XN09-C	63	75.2	22	48	40	6		5	XN..0906..
AFM45-080-Z06-A27R-XN09-C	80	92.2	27	62	50	6		6	
AFM45-100-Z07-A32R-XN09-C	100	112.2	32	80	50	6		7	
AFM45-100-Z08-A32R-XN09-C	100	112.2	32	80	50	6		8	
AFM45-125-Z08-A40R-XN09-C	125	137.2	40	87	63	6		8	
AFM45-125-Z10-A40R-XN09-C	125	137.2	40	87	63	6		10	
AFM45-160-Z09-A40R-XN09	160	172.2	40	107	63	6		9	
AFM45-160-Z11-A40R-XN09	160	172.2	40	107	63	6		11	
AFM45-200-Z12-A60R-XN09	200	212.2	60	130	63	6		12	
AFM45-250-Z12-A60R-XN09-S	250	262.8	60	180	63	6		12	
AFM45-315-Z14-A60R-XN09-S	315	328.2	60	240	63	6		14	

Dimension (mm)	Spare parts					
Cutter diameter	Screw	Wrench	Shim	Shim screw	Shim screw wrench	Torque
ø63-315						5.0Nm
	SP050130	DT-TP20	S-XN09040	SS080100F	LT-H5	

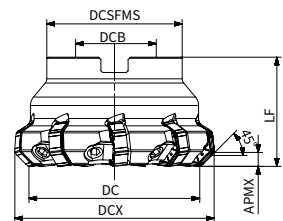

AFM45-XN09-W

45° Wedge clamping face milling cutter

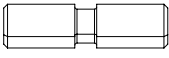

Product code	DC	DCX	DCB	DCSFMS	LF	APMX	Internal coolant	Z	Inserts
AFM45-080-Z09-A27R-XN09-W	80	92.7	27	62	50	6		9	XN..0906..
AFM45-100-Z12-A32R-XN09-W	100	112.7	32	80	50	6		12	
AFM45-125-Z16-A40R-XN09-W	125	137.7	40	87	63	6		16	
AFM45-125-Z16-A40L-XN09-W	125	137.7	40	87	63	6		16	
AFM45-160-Z20-A40R-XN09-W	160	172.7	40	107	63	6		20	
AFM45-160-Z20-A40L-XN09-W	160	172.7	40	107	63	6		20	
AFM45-200-Z26-A60R-XN09-W	200	212.7	60	130	63	6		26	
AFM45-200-Z26-A60L-XN09-W	200	212.7	60	130	63	6		26	
AFM45-250-Z30-A60R-XN09-W	250	262.7	60	170	63	6		30	
AFM45-315-Z39-A60R-XN09-W	315	327.7	60	250	63	6		39	

Note: With internal coolant
 Without internal coolant

Dimension (mm)	Spare parts			
Cutter diameter	Wedge	Screw	Wrench	Touque
ø80-315				7.0Nm
	AWG-8H	WD080320F	LT-H4	

Product code	Dimension (mm)		P			M	K		N
	Corner radius	Wiper length	AP251U	AP351U	AC301P	AP403M	AC301K	AP251K	AW100K
XNGU 0906ANN-MM3	0.8	1.4	●	▲	▲		▲		
XNGU 0906ANN-MM4	0.8	1.4	●	▲	▲		▲		
XNMU 0906ANN-MR6	0.8	1.4	●				▲	●	
XNMF 0906ANN-MR6	0.8	1.4					▲	●	
XNMU 090612-MM4	1.2	-	●	▲		●	▲	●	
XNGX 0906ANN-W	1.0	7.5	●				▲		

●: Stock available ▲: Stock available now but will be replaced in the future.

Materials				Cutting depth and feed								
ISO	Material classification	Tensile strength (N/mm ²)	Hardness (HB)	XN..0906..								
				ap	Geometry			fz				
			MM3			MM4		MR6				
				(mm)								
				min	max	min	max	min	max	min	max	
P	Unalloyed steel	<600	<180	0.20	6.00	0.15	0.35	0.18	0.38	0.18	0.40	
		<950	<280									
	Alloyed steel	700-950	200-280			0.12	0.32	0.15	0.35	0.15	0.38	
		950-1200	280-355									
	1200-1400	355-415										
M	Duplex stainless steel	778	230									
	Austenitic stainless steel	675	200			0.12	0.30	0.12	0.32	-	-	
	Precipitation-hardening stainless steel	1013	300									
K	Grey cast iron	700	220									
	Nodular cast iron	880	260			0.15	0.35	0.18	0.38	0.18	0.40	
	Malleable cast iron	800	250									
N	Aluminum	260	75									
	Aluminum alloy	447	130	-	-	-	-	-	-			
S	Fe-based alloy	943	280									
	Co-based alloy	1076	320	0.10	0.25	0.12	0.28	-	-			
	Ni-based alloy	1177	350									
	Ti-alloy	1262	370									
H	Hardened steel	-	50-60HRC									
	Chilled cast iron	-	55HRC									

*The recommended cutting conditions always refer to general conditions. These cutting conditions should be adjusted according to the practical machine rigidity, tools, workpiece clamping and coolant. Average chip thickness (hm)=fz x sinkr.

Milling cutters

AFF40-LN12/LN15

Cast iron finishing milling cutter

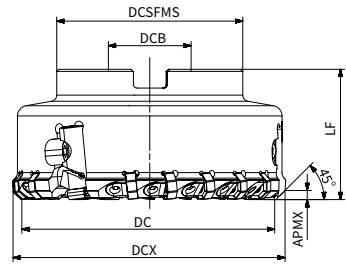

Product code	DC	DCX	DCB	DCSFMS	LF	APMX	Internal coolant	*Z	Number of Wiper insert	Inserts
AFF40-080-Z08-A27R-LN12	80	88.4	27	65	50	0.5		8+2	2	ONHF 050408-MM3 LNHQ 120408FN-W
AFF40-100-Z10-A32R-LN12	100	108.4	32	80	50	0.5		10+2	2	ONHF 050408-MM3 LNHQ 150416FN-W
AFF40-125-Z15-A40R-LN15	125	133.4	40	90	63	0.5		15+3	3	
AFF40-160-Z18-A40R-LN15	160	168.4	40	120	63	0.5		18+3	3	
AFF40-200-Z24-A60R-LN15	200	208.4	60	160	63	0.5		24+3	3	
AFF40-250-Z30-A60R-LN15	250	258.4	60	200	63	0.5		30+3	3	

*means 8pcs rough inserts+2pcs finish inserts

Dimension (mm)	Spare parts				
Cutter diameter	Wedge	Wedge locking screw	Wiper insert locking screw	Wiper insert adjusting screw	Wiper cartridge locking screw
ø80-250					
	AWG-6H-13B	WD060200	SP040085H	AH050100F	SH060250

Dimension (mm)	Spare parts				
Cutter diameter	Wedge screw wrench	Wiper insert screw wrench	Wiper insert adjusting screw wrench	Wiper insert cartridge locking screw wrench	Wiper cartridge
ø80-250					
	LT-H3	DT-TP10	LT-H2.5	LT-H5	ø80-100 ø125-250
					C-LN1235-2545 C-LN1535-2545

Note: With internal coolant
 Without internal coolant

Product code	Dimension (mm)		P		M	K		H
	Corner radius	Wiper length	AP251U	AP351U	AP403M	AC301K	AP251K	AP151H
ONHF 050408-MM3	0.8	-						●
LNHQ 120408FN-W	0.8	-						●
LNHQ 150416FN-W	1.6	-						●

●: Stock available ▲: Stock available now but will be replaced in the future.

Materials				Cutting depth and feed			
ISO	Material classification	Tensile strength (N/mm ²)	Hardness (HB)	ONHF..05 + LNHQ..12/15			
				ap		Geometry	
		MM3 + W					
				fz			
(mm)							
				min	max	min	max
	Grey cast iron	700	220	0.20	0.50	0.08	0.25
	Nodular cast iron	880	260				
	Malleable cast iron	800	250				

*The recommended cutting conditions always refer to general conditions. These cutting conditions should be adjusted according to the practical machine rigidity, tools, workpiece clamping and coolant. Average chip thickness (hm)=fz x sinkr.

Milling cutters

ASM90-LN12

Square shoulder milling cutter

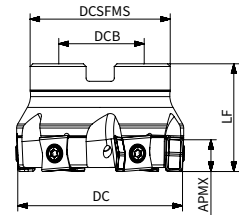
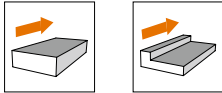

Product code	DC	DCB	DCSFMS	LF	APMX	Internal coolant	Z	Inserts
ASM90-063-Z06-A22R-LN12-C	63	22	52	40	5		6	LN..1206..
ASM90-063-Z06-A22L-LN12-C	63	22	52	40	5		6	
ASM90-063-Z08-A22R-LN12	63	22	52	40	5		8	
ASM90-063-Z08-A22L-LN12	63	22	52	40	5		8	
ASM90-080-Z08-A27R-LN12-C	80	27	62	50	5		8	
ASM90-080-Z08-A27L-LN12-C	80	27	62	50	5		8	
ASM90-080-Z10-A27R-LN12	80	27	62	50	5		10	
ASM90-080-Z10-A27L-LN12	80	27	62	50	5		10	
ASM90-100-Z09-A32R-LN12	100	32	78	50	5		9	
ASM90-100-Z09-A32L-LN12	100	32	78	50	5		9	
ASM90-100-Z13-A32R-LN12	100	32	78	50	5		13	
ASM90-100-Z13-A32L-LN12	100	32	78	50	5		13	
ASM90-125-Z10-A40R-LN12	125	40	90	63	5		10	
ASM90-125-Z10-A40L-LN12	125	40	90	63	5		10	
ASM90-125-Z16-A40R-LN12	125	40	90	63	5		16	
ASM90-125-Z16-A40L-LN12	125	40	90	63	5		16	
ASM90-160-Z13-A40R-LN12	160	40	107	63	5		13	
ASM90-160-Z13-A40L-LN12	160	40	107	63	5		13	
ASM90-160-Z21-A40R-LN12	160	40	107	63	5		21	
ASM90-160-Z21-A40L-LN12	160	40	107	63	5		21	
ASM90-200-Z16-A60R-LN12	200	60	130	63	5		16	
ASM90-200-Z16-A60L-LN12	200	60	130	63	5		16	
ASM90-200-Z26-A60R-LN12	200	60	130	63	5		26	
ASM90-200-Z26-A60L-LN12	200	60	130	63	5		26	
ASM90-250-Z20-A60R-LN12	250	60	180	63	5		20	
ASM90-250-Z20-A60L-LN12	250	60	180	63	5		20	
ASM90-250-Z32-A60R-LN12	250	60	180	63	5		32	
ASM90-250-Z32-A60L-LN12	250	60	180	63	5		32	

Dimension (mm)	Spare parts		
Cutter diameter	Screw	Wrench	Torque
∅63-250			3.5Nm
	SP040112	DT-TP15	

Note: With internal coolant
 Without internal coolant

Product code	Dimension (mm)		P			M	K		N
	Corner radius	Wiper length	AP251U	AP351U	AC301P	AP403M	AC151K	AP251K	AW100K
LNET 1206-MM4	0.8	2.5	●			●	●	●	

● : Stock available ▲ : Stock available now but will be replaced in the future.

Materials				Cutting depth and feed							
ISO	Material classification	Tensile strength (N/mm ²)	Hardness (HB)	LN..1206..							
				ap		MM4					
						(mm)					
				min	max	min	max				
P	Unalloyed steel	<600	<180	0.20	5.00	0.08	0.35				
		<950	<280								
	Alloyed steel	700-950	200-280					0.08	0.30		
		950-1200	280-355								
M	Duplex stainless steel	778	230			0.20	5.00	0.05	0.25		
	Austenitic stainless steel	675	200								
	Precipitation-hardening stainless steel	1013	300								
K	Grey cast iron	700	220					0.20	5.00	0.10	0.35
	Nodular cast iron	880	260								
	Malleable cast iron	800	250								
N	Aluminum	260	75	0.20	5.00					-	-
	Aluminum alloy	447	130								
S	Fe-based alloy	943	280			0.20	5.00			0.05	0.20
	Co-based alloy	1076	320								
	Ni-based alloy	1177	350								
	Ti-alloy	1262	370								
H	Hardened steel	-	50-60HRC					0.20	5.00	-	-
	Chilled cast iron	-	55HRC								

*The recommended cutting conditions always refer to general conditions. These cutting conditions should be adjusted according to the practical machine rigidity, tools, workpiece clamping and coolant. Average chip thickness (hm)=fz x sinkr.

Milling cutters

ASM90-LN09

Square shoulder milling cutter

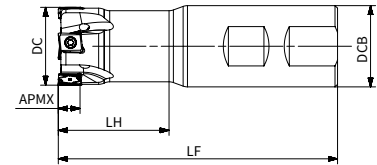
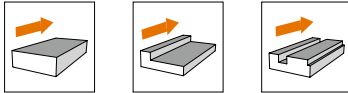

Product code	DC	DCB	LF	LH	APMX	Internal coolant	Z	Inserts
ASM90-025-Z03-W25R-LN09-C	25	25	100	39	8		3	LNHU 0904..
ASM90-025-Z04-W25R-LN09-C	25	25	100	39	8		4	
ASM90-032-Z04-W32R-LN09-C	32	32	110	44	8		4	
ASM90-032-Z05-W32R-LN09-C	32	32	110	44	8		5	
ASM90-040-Z04-W32R-LN09-C	40	32	110	25	8		4	
ASM90-040-Z06-W32R-LN09-C	40	32	110	25	8		6	

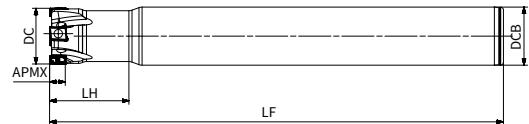

Product code	DC	DCB	LF	LH	APMX	Internal coolant	Z	Inserts
ASM90-020-Z02-C20R-LN09-L110	20	20	110	30	8		2	LNHU 0904..
ASM90-020-Z03-C20R-LN09-L110	20	20	110	30	8		3	
ASM90-021-Z02-C20R-LN09-L200	21	20	200	30	8		2	
ASM90-025-Z03-C25R-LN09-L200-C	25	25	200	34	8		3	
ASM90-025-Z04-C25R-LN09-L200-C	25	25	200	34	8		4	
ASM90-026-Z03-C25R-LN09-L200-C	26	25	200	34	8		3	
ASM90-028-Z03-C25R-LN09-L110-C	28	25	110	34	8		3	
ASM90-032-Z04-C32R-LN09-L250-C	32	32	250	45	8		4	
ASM90-032-Z05-C32R-LN09-L250-C	32	32	250	45	8		5	
ASM90-033-Z04-C32R-LN09-L250-C	33	32	250	45	8		4	

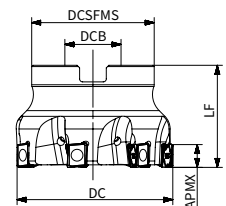

Product code	DC	DCB	LF	DCSFMS	APMX	Internal coolant	Z	Inserts
ASM90-040-Z04-A16R-LN09-C	40	16	40	35	8		4	LNHU 0904..
ASM90-040-Z06-A16R-LN09-C	40	16	40	35	8		6	
ASM90-050-Z05-A22R-LN09-C	50	22	40	42	8		5	
ASM90-050-Z07-A22R-LN09-C	50	22	40	42	8		7	
ASM90-063-Z07-A22R-LN09-C	63	22	40	48	8		7	
ASM90-063-Z10-A22R-LN09-C	63	22	40	48	8		10	
ASM90-080-Z09-A27R-LN09-C	80	27	50	62	8		9	
ASM90-080-Z13-A27R-LN09-C	80	27	50	62	8		13	

Note: With internal coolant
 Without internal coolant

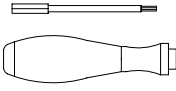
Dimension (mm)	Spare parts		
Cutter diameter	Screw	Wrench	Torque
∅20-80			1.8Nm
	SP030083	DT-TP09	

Product code	Dimension (mm)		P			M	K		N
	Corner radius	Wiper length	AP251U	AP351U	AP351M	AP403M	AC301K	AP251K	AW100K
LNHU 090404ER-FM2	0.4	1.85				●			●
LNHU 090404ER-MM3	0.4	1.85		▲		●			
LNHU 090404ER-MR2	0.4	1.85	●	▲		●	▲	●	
LNHU 090404ER-MM4	0.4	1.85	●		●	●		●	
LNHU 090408ER-MM4	0.8	1.3	●		●	●		●	
LNHU 090408ER-MR2	0.8	1.3	●	▲		●	▲	●	
LNHU 090408ER-MM3	0.8	1.3	●		●	●		●	
LNHU 090412ER-MR2	1.2	1.0	●			●	▲		
LNHU 090416ER-MR2	1.6	0.65	●			●	▲		
LNHU 090420ER-MR2	2.0	0.65	●			●	▲		
LNHU 0904PDER-W	0.4	3.6	●				▲		

●: Stock available ▲: Stock available now but will be replaced in the future.

Materials				Cutting depth and feed													
ISO	Material classification	Tensile strength (N/mm ²)	Hardness (HB)	LNHU 0904..													
				ap	Geometry			fz									
					MR2	MM4	FM2	(mm)									
					min	max	min	max	min	max	min	max					
P	Unalloyed steel	<600	<180	0.20	8.00	0.08	0.28	0.08	0.25	-	-						
		<950	<280														
	Alloyed steel	700-950	200-280									0.06	0.22	0.06	0.20	-	-
		950-1200	280-355														
M	Duplex stainless steel	778	230			0.06	0.22	0.06	0.20	-	-						
	Austenitic stainless steel	675	200														
	Precipitation-hardening stainless steel	1013	300														
K	Grey cast iron	700	220			0.08	0.30	0.08	0.28	-	-						
	Nodular cast iron	880	260														
	Malleable cast iron	800	250														
N	Aluminum	260	75			-	-	-	-	0.06	0.25						
	Aluminum alloy	447	130														
S	Fe-based alloy	943	280	-	-	0.08	0.15	-	-								
	Co-based alloy	1076	320														
	Ni-based alloy	1177	350														
	Ti-alloy	1262	370														
H	Hardened steel	-	50-60HRC	-	-	-	-	-	-								
	Chilled cast iron	-	55HRC														

*The recommended cutting conditions always refer to general conditions. These cutting conditions should be adjusted according to the practical machine rigidity, tools, workpiece clamping and coolant. Average chip thickness (hm)=fz x sinkr.

ASM90-LN13

Square shoulder milling cutter

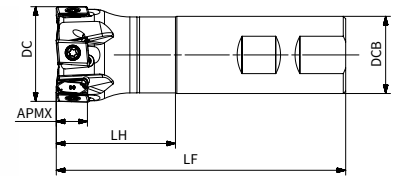
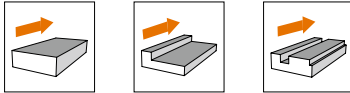

Product code	DC	DCB	LF	LH	APMX	Internal coolant	Z	Inserts
ASM90-040-Z05-W32R-LN13-C	40	32	120	49	12		5	LNHU 1306..

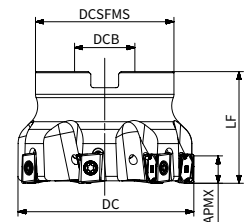

Product code	DC	DCB	LF	DCSFMS	APMX	Internal coolant	Z	Inserts
ASM90-040-Z04-A16R-LN13-C	40	16	40	35	12		4	LNHU 1306..
ASM90-040-Z05-A16R-LN13-C	40	16	40	35	12		5	
ASM90-050-Z05-A22R-LN13-C	50	22	40	42	12		5	
ASM90-050-Z06-A22R-LN13-C	50	22	40	42	12		6	
ASM90-063-Z04-A22R-LN13-C	63	22	40	48	12		4	
ASM90-063-Z06-A22R-LN13-C	63	22	40	48	12		6	
ASM90-063-Z08-A22R-LN13-C	63	22	40	48	12		8	
ASM90-080-Z05-A27R-LN13-C	80	27	50	62	12		5	
ASM90-080-Z07-A27R-LN13-C	80	27	50	62	12		7	
ASM90-080-Z10-A27R-LN13-C	80	27	50	62	12		10	
ASM90-100-Z07-A32R-LN13-C	100	32	50	80	12		7	
ASM90-100-Z09-A32R-LN13-C	100	32	50	80	12		9	
ASM90-100-Z13-A32R-LN13-C	100	32	50	80	12		13	
ASM90-125-Z09-A40R-LN13-C	125	40	63	87	12		9	
ASM90-125-Z11-A40R-LN13-C	125	40	63	87	12		11	
ASM90-125-Z16-A40R-LN13-C	125	40	63	87	12		16	
ASM90-160-Z09-A40R-LN13	160	40	63	107	12		9	
ASM90-160-Z13-A40R-LN13	160	40	63	107	12		13	
ASM90-200-Z12-A60R-LN13	200	60	63	140	12		12	
ASM90-250-Z12-A60R-LN13-M	250	60	63	180	12		12	
ASM90-315-Z14-A60R-LN13-M	315	60	63	220	12		14	

Dimension (mm)	Spare parts								
	Cutter diameter	Screw	Wrench	Wedge	Wedge wrench	Wedge screw	Cartridge	Cartridge wrench	Cartridge screw
Ø40-315									3.5Nm
	SP040115	DT-TP15	AWG-6H-6	LT-H3	AWCH624	C-LN1342-62-90	LT-H5	ACH622	

Note: With internal coolant
 Without internal coolant

Product code	Dimension (mm)		P			M	K		N
	Corner radius	Wiper length	AP251U	AP351U	AP351M	AP403M	AC301K	AP251K	AW100K
LNHU 130608ER-FM2	0.8	2.7							●
LNHU 130608ER-MM3	0.8	2.7		▲		●			
LNHU 130608ER-MM4	0.8	2.7	●		●	●		●	
LNHU 130608ER-MR2	0.8	2.7	●	▲	●	●	▲	●	
LNHU 130612ER-MM4	1.2	2.3	●		●	●		●	
LNHU 130612ER-MR2	1.2	2.3	●	▲	●	●	▲		
LNHU 130616ER-MR2	1.6	1.9	●	▲	●	●	▲	●	
LNHU 130620ER-MR2	2.0	1.5	●	▲	●	●			
LNHU 130624ER-MR2	2.4	1.0		▲	●	●			
LNHU 130631ER-MR2	3.1	0.4		▲	●	●	▲		
LNHU 1306PDR-W	0.8	5.6	●				▲		

●: Stock available ▲: Stock available now but will be replaced in the future.

Materials				Cutting depth and feed						
ISO	Material classification	Tensile strength (N/mm ²)	Hardness (HB)	LNHU..1306..						
				ap	Geometry					
					MM3		MR2			
					fz					
				(mm)						
min	max	min	max	min	max					
P	Unalloyed steel	<600	<180	0.3	12.00	0.10	0.30	0.12	0.35	
		<950	<280							
	Alloyed steel	700-950	200-280			0.08	0.25	0.10	0.30	
		950-1200	280-355							
1200-1400		355-415								
M	Duplex stainless steel	778	230							
	Austenitic stainless steel	675	200			0.06	0.20	0.08	0.25	
	Precipitation-hardening stainless steel	1013	300							
K	Grey cast iron	700	220							
	Nodular cast iron	880	260			-	-	0.12	0.35	
	Malleable cast iron	800	250							
N	Aluminum	260	75							
	Aluminum alloy	447	130							
S	Fe-based alloy	943	280							
	Co-based alloy	1076	320							
	Ni-based alloy	1177	350	0.06	0.18	0.08	0.22			
	Ti-alloy	1262	370							
H	Hardened steel	-	50-60HRC							
	Chilled cast iron	-	55HRC			0.08	0.20			

*The recommended cutting conditions always refer to general conditions. These cutting conditions should be adjusted according to the practical machine rigidity, tools, workpiece clamping and coolant. Average chip thickness (hm)=fz x sinkr.

Milling cutters

ASM90-LN16

Square shoulder milling cutter

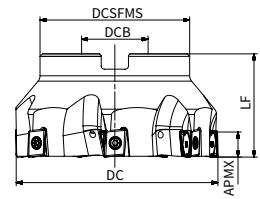
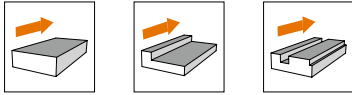

Product code	DC	DCB	LF	DCSFMS	APMX	Internal coolant	Z	Inserts
ASM90-063-Z04-A22R-LN16-C	63	22	40	52	15		4	LNHU 1607..
ASM90-080-Z05-A27R-LN16-C	80	27	50	62	15		5	
ASM90-100-Z06-A32R-LN16-C	100	32	50	80	15		6	
ASM90-125-Z07-A40R-LN16-C	125	40	63	87	15		7	
ASM90-160-Z08-A40R-LN16	160	40	63	107	15		8	

Dimension (mm)	Spare parts		
Cutter diameter	Screw	Wrench	Torque
Ø63-160			5Nm
	ST05013063	DT-T20	

Note: With internal coolant
 Without internal coolant

Product code	Dimension (mm)		P			M	K		N
	Corner radius	Wiper length	AP251U	AP351U	AP351M	AP403M	AC301K	AP251K	AW100K
LNHU 160708ER-MR2	0.8	1.97	●	▲			▲	●	
LNHU 160716ER-MR2	1.6	1.5	●				▲		

●: Stock available ▲: Stock available now but will be replaced in the future.

Materials				Cutting depth and feed			
ISO	Material classification	Tensile strength (N/mm ²)	Hardness (HB)	LNHU 1607..			
				ap	Geometry		
					MR2		
					fz		
(mm)				min	max	min	max
P	Unalloyed steel	<600	<180	0.30	15.00	0.10	0.30
		<950	<280				
	Alloyed steel	700-950	200-280				
		950-1200	280-355				
1200-1400		355-415					
M	Duplex stainless steel	778	230				
	Austenitic stainless steel	675	200				
	Precipitation-hardening stainless steel	1013	300				
K	Grey cast iron	700	220				
	Nodular cast iron	880	260				
	Malleable cast iron	800	250				
N	Aluminum	260	75	-	-		
	Aluminum alloy	447	130	-	-		
S	Fe-based alloy	943	280	-	-		
	Co-based alloy	1076	320	-	-		
	Ni-based alloy	1177	350	-	-		
	Ti-alloy	1262	370	-	-		
H	Hardened steel	-	50-60HRC	-	-		
	Chilled cast iron	-	55HRC	-	-		

*The recommended cutting conditions always refer to general conditions. These cutting conditions should be adjusted according to the practical machine rigidity, tools, workpiece clamping and coolant. Average chip thickness (hm)=fz x sinkr.

Milling cutters

ASM90-WN08

Square shoulder milling cutter

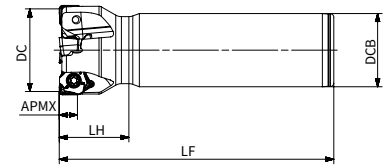
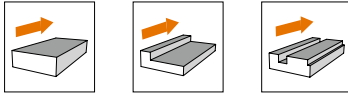

Product code	DC	DCB	LF	LH	APMX	Internal coolant	Z	Inserts
ASM90-040-Z03-W32R-WN08-C	40	32	120	31	7		3	WNGU 0806..
ASM90-040-Z04-W32R-WN08-C	40	32	120	31	7		4	

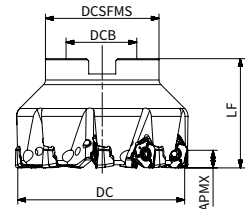

Product code	DC	DCB	LF	DCSFMS	APMX	Internal coolant	Z	Inserts
ASM90-050-Z04-A22R-WN08-C	50	22	40	42	7		4	WNGU 0806..
ASM90-050-Z05-A22R-WN08-C	50	22	40	42	7		5	
ASM90-063-Z04-A22R-WN08-C	63	22	40	48	7		4	
ASM90-063-Z06-A22R-WN08-C	63	22	40	48	7		6	
ASM90-063-Z07-A22R-WN08-C	63	22	40	48	7		7	
ASM90-080-Z05-A27R-WN08-C	80	27	50	62	7		5	
ASM90-080-Z07-A27R-WN08-C	80	27	50	62	7		7	
ASM90-080-Z09-A27R-WN08-C	80	27	50	62	7		9	
ASM90-100-Z06-A32R-WN08-C	100	32	50	80	7		6	
ASM90-100-Z08-A32R-WN08-C	100	32	50	80	7		8	
ASM90-100-Z11-A32R-WN08-C	100	32	50	80	7		11	
ASM90-125-Z07-A40R-WN08-C	125	40	63	87	7		7	
ASM90-125-Z11-A40R-WN08-C	125	40	63	87	7		11	
ASM90-125-Z13-A40R-WN08-C	125	40	63	87	7		13	
ASM90-160-Z08-A40R-WN08	160	40	63	107	7		8	
ASM90-160-Z12-A40R-WN08	160	40	63	107	7		12	
ASM90-200-Z14-A60R-WN08	200	60	63	140	7		14	
ASM90-250-Z16-A60R-WN08	250	60	63	180	7		16	

Dimension (mm)	Spare parts		
Cutter diameter	Screw	Wrench	Torque
∅40-250			3.5Nm
	SP040090	DT-TP15	

Note: With internal coolant
 Without internal coolant

Product code	Dimension (mm)		P				M	K		N	H
	Corner radius	Wiper length	AP251U	AP351U	AP351M	AP401U	AP403M	AC301K	AP251K	AW100K	AP151H
WNHU 080608R-FM2	0.8	2.0								●	
WNGU 080604R-MM3	0.4	2.2		▲	●	▲					
WNGU 080608R-MM3	0.8	2.0	●	▲	●	▲	●		●		
WNGU 080604R-MM4	0.4	2.2	●	▲	●	▲			●		
WNGU 080608R-MM4	0.8	2.0	●	▲	●	▲		▲	●		●
WNGU 080612R-MM4	1.2	1.6	●	▲	●	▲					
WNGU 080616R-MM4	1.6	1.2	●	▲	●	▲					
WNGU 080608R-MR2	0.8	2.0	●	▲	●		●	▲	●		
WNGU 080612R-MR2	1.2	1.6	●		●				●		
WNGU 080616R-MR2	1.6	1.2	●		●				●		
WNHX 0806ZZR-W	1.0	4.8	●					●			

●: Stock available ▲: Stock available now but will be replaced in the future.

Materials				Cutting depth and feed											
ISO	Material classification	Tensile strength (N/mm ²)	Hardness (HB)	WNGU..0806..											
				ap	Geometry				fz						
					FM2		MM3		MM4		MR2				
					(mm)										
min	max	min	max	min	max	min	max	min	max						
P	Unalloyed steel	<600	<180	0.60	8.00			0.12	0.25	0.12	0.28	0.12	0.30		
		<950	<280												
	Alloyed steel	700-950	200-280					0.10	0.20	0.10	0.25	0.10	0.28		
		950-1200	280-355												
	1200-1400	355-415													
M	Duplex stainless steel	778	230					-	-						
	Austenitic stainless steel	675	200					0.08	0.18	0.08	0.18	-	-		
	Precipitation-hardening stainless steel	1013	300												
K	Grey cast iron	700	220							0.12	0.20	0.10	0.28	0.15	0.30
	Nodular cast iron	880	260												
	Malleable cast iron	800	250												
N	Aluminum	260	75					0.10	0.24	-	-	-	-	-	-
	Aluminum alloy	447	130												
S	Fe-based alloy	943	280			0.12	0.13	0.10	0.15	-	-				
	Co-based alloy	1076	320												
	Ni-based alloy	1177	350												
	Ti-alloy	1262	370												
H	Hardened steel	-	50-60HRC												
	Chilled cast iron	-	55HRC												

*The recommended cutting conditions always refer to general conditions. These cutting conditions should be adjusted according to the practical machine rigidity, tools, workpiece clamping and coolant. Average chip thickness (hm)=fz x sinkr.

Milling cutters

ASM90-WN08-N

Square shoulder milling cutter

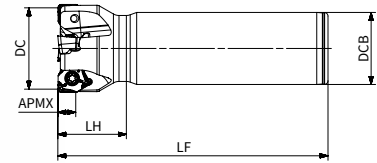
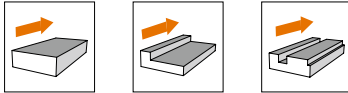

Product code	DC	DCB	LF	LH	APMX	Internal coolant	Z	Inserts
ASM90-040-Z03-W32R-WN08-N-C	40	32	120	30	8		3	WNMU 0806..
ASM90-040-Z04-W32R-WN08-N-C	40	32	120	30	8		4	

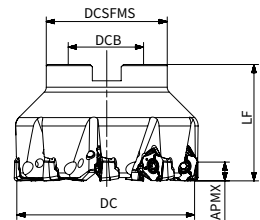

Product code	DC	DCB	LF	DCSFMS	APMX	Internal coolant	Z	Inserts
ASM90-050-Z04-A22R-WN08-N-C	50	22	40	42	7		4	WNMU 0806..
ASM90-050-Z05-A22R-WN08-N-C	50	22	40	42	7		5	
ASM90-063-Z04-A22R-WN08-N-C	63	22	40	48	7		4	
ASM90-063-Z06-A22R-WN08-N-C	63	22	40	48	7		6	
ASM90-063-Z07-A22R-WN08-N-C	63	22	40	48	7		7	
ASM90-080-Z05-A27R-WN08-N-C	80	27	50	62	7		5	
ASM90-080-Z07-A27R-WN08-N-C	80	27	50	62	7		7	
ASM90-080-Z09-A27R-WN08-N-C	80	27	50	62	7		9	
ASM90-100-Z06-A32R-WN08-N-C	100	32	50	80	7		6	
ASM90-100-Z08-A32R-WN08-N-C	100	32	50	80	7		8	
ASM90-100-Z11-A32R-WN08-N-C	100	32	50	80	7		11	
ASM90-125-Z07-A40R-WN08-N-C	125	40	63	87	7		7	
ASM90-125-Z11-A40R-WN08-N-C	125	40	63	87	7		11	
ASM90-125-Z13-A40R-WN08-N-C	125	40	63	87	7		13	
ASM90-160-Z08-A40R-WN08-N	160	40	63	107	7		8	
ASM90-160-Z12-A40R-WN08-N	160	40	63	107	7		12	
ASM90-200-Z14-A60R-WN08-N	200	60	63	140	7		14	
ASM90-250-Z16-A60R-WN08-N	250	60	63	180	7		16	

Dimension (mm)	Spare parts		
Cutter diameter	Screw	Wrench	Torque
∅40-250			3.5Nm
	SP040112	DT-TP15	

Note: With internal coolant
 Without internal coolant

Product code	Dimension (mm)		P		M	K	
	Corner radius	Wiper length	AP251U	AP351M	AP403M	AC301K	AP251K
WNMU 080608R-MR2	0.8	2.3	●	●	●	▲	●
WNMU 080608R-MM4	0.8	2.3	●	●	●	▲	●
WNMU 080608R-MM3	0.8	2.3	●	●	●	▲	●
WNMU 080612R-MR2	1.2	1.19	●	●		▲	●
WNMU 080612R-MM4	1.2	1.18	●	●	●		●
WNMU 080616R-MR2	1.6	0.81	●		●		
WNMU 080616R-MM4	1.6	0.8	●		●		

●: Stock available ▲: Stock available now but will be replaced in the future.

Materials				Cutting depth and feed							
ISO	Material classification	Tensile strength (N/mm ²)	Hardness (HB)	WNMU 0806..							
				ap	MM3		MM4		MR2		
					(mm)						
		min	max	min	max	min	max	min	max		
P	Unalloyed steel	<600	<180	0.60	8.00	0.12	0.25	0.12	0.28	0.12	0.30
		<950	<280								
	Alloyed steel	700-950	200-280			0.10	0.20	0.10	0.25	0.10	0.28
		950-1200	280-355								
	1200-1400	355-415									
M	Duplex stainless steel	778	230								
	Austenitic stainless steel	675	200			0.08	0.18	0.08	0.18	-	-
	Precipitation-hardening stainless steel	1013	300								
K	Grey cast iron	700	220								
	Nodular cast iron	880	260			0.12	0.20	0.10	0.28	0.15	0.30
	Malleable cast iron	800	250								
S	Fe-based alloy	943	280								
	Co-based alloy	1076	320								
	Ni-based alloy	1177	350	0.12	0.13	0.10	0.15	-	-		
	Ti-alloy	1262	370								
H	Hardened steel	-	50-60HRC								
	Chilled cast iron	-	55HRC								

*The recommended cutting conditions always refer to general conditions. These cutting conditions should be adjusted according to the practical machine rigidity, tools, workpiece clamping and coolant. Average chip thickness (hm)=fz x sinkr.

Milling cutters

ASM90-AP17

Square shoulder milling cutter

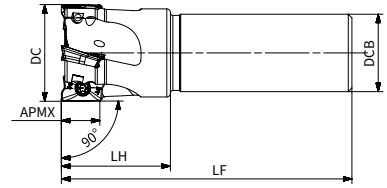
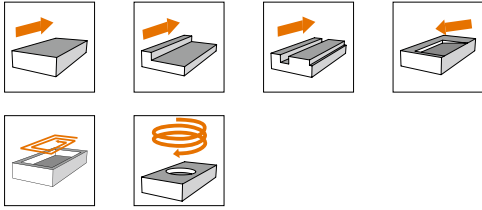

Product code	DC	DCB	LF	LH	APMX	Internal coolant	Z	Inserts
ASM90-025-Z02-C25R-AP17-L100-C	25	25	100	39	16		2	APKT 1705..
ASM90-032-Z03-C32R-AP17-L110-C	32	32	110	40	16		3	
ASM90-032-Z03-C32R-AP17-L200-C	32	32	200	40	16		3	
ASM90-040-Z04-C32R-AP17-L120-C	40	32	120	45	16		4	

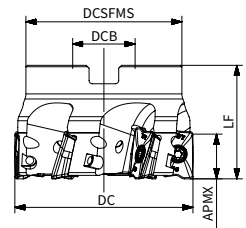

Product code	DC	DCB	LF	DCSFMS	APMX	Internal coolant	Z	Inserts
ASM90-050-Z05-A22R-AP17-C	50	22	40	45	16		5	APKT 1705..
ASM90-063-Z06-A22R-AP17-C	63	22	40	55	16		6	
ASM90-080-Z06-A27R-AP17-C	80	27	50	62	16		6	
ASM90-100-Z08-A32R-AP17-C	100	32	50	78	16		8	

Dimension (mm)	Spare parts		
	Screw	Wrench	Torque
Ø25	SP040084	DT-TP15	4.0Nm
Ø32-100	SP040100H		

Note: With internal coolant
 Without internal coolant

Product code	Dimension (mm)		P			M	K		S	N
	Corner radius	Wiper length	AP251U	AP351U	AP351M	AP403M	AC301K	AP251K	AP403S	AW100K
APKT 1705PDER-DT	0.8	2.16	●	▲		●		●		●
APKT 170516R-DT	1.6	1.7	●					●		
APKT 170524R-DT	2.4	0.95	●		●	●		●		
APKT 170530R-DT	3.0	0.48	●		●	●		●		
APKT 170540R-DT	4.0	-	●		●	●				

●: Stock available ▲: Stock available now but will be replaced in the future.

Materials				Cutting depth and feed			
ISO	Material classification	Tensile strength (N/mm ²)	Hardness (HB)	APKT..1705..			
				ap		DT	
						fz	
				(mm)			
		min	max	min	max		
P	Unalloyed steel	<600	<180	0.10	16.00	0.08	0.25
		<950	<280				
	Alloyed steel	700-950	200-280			0.06	0.22
		950-1200	280-355				
	1200-1400	355-415					
M	Duplex stainless steel	778	230			0.06	0.20
	Austenitic stainless steel	675	200				
	Precipitation-hardening stainless steel	1013	300				
K	Grey cast iron	700	220			0.08	0.25
	Nodular cast iron	880	260				
	Malleable cast iron	800	250				
N	Aluminum	260	75	0.06	0.30		
	Aluminum alloy	447	130				
S	Fe-based alloy	943	280	0.06	0.18		
	Co-based alloy	1076	320				
	Ni-based alloy	1177	350				
	Ti-alloy	1262	370				
H	Hardened steel	-	50-60HRC	-	-		
	Chilled cast iron	-	55HRC				

*The recommended cutting conditions always refer to general conditions. These cutting conditions should be adjusted according to the practical machine rigidity, tools, workpiece clamping and coolant. Average chip thickness (hm)=fz x sinkr.

ASM90-TD15

Square shoulder milling cutter

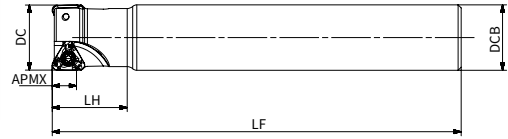
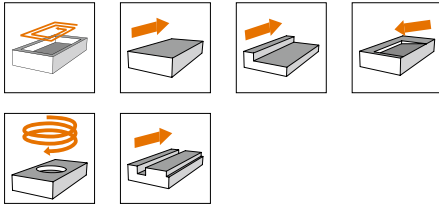



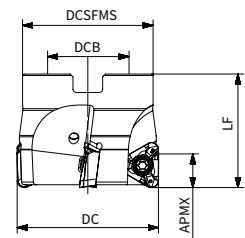
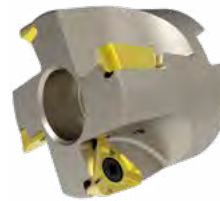



Product code	DC	DCB	LF	LH	APMX	Internal coolant	Z	Inserts
ASM90-032-Z02-C32R-TD15-C	32	32	110	37	11		2	TD.T 1505..
ASM90-032-Z02-C32R-TD15-L200-C	32	32	200	37	11		2	
ASM90-040-Z03-C32R-TD15-C	40	32	120	38	11		3	
ASM90-040-Z03-C32R-TD15-L200-C	40	32	200	38	11		3	

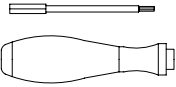

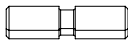
Product code	DC	DCB	LF	DCSFMS	APMX	Internal coolant	Z	Inserts
ASM90-040-Z04-A16R-TD15-C	40	16	40	35	11		4	TD.T 1505..
ASM90-050-Z04-A22R-TD15-C	50	22	40	42	11		4	
ASM90-050-Z05-A22R-TD15-C	50	22	40	42	11		5	
ASM90-063-Z04-A22R-TD15-C	63	22	40	48	11		4	
ASM90-063-Z05-A22R-TD15-C	63	22	40	48	11		5	
ASM90-063-Z06-A22R-TD15-C	63	22	40	48	11		6	
ASM90-080-Z05-A27R-TD15-C	80	27	50	62	11		5	
ASM90-080-Z06-A27R-TD15-C	80	27	50	62	11		6	
ASM90-080-Z07-A27R-TD15-C	80	27	50	62	11		7	
ASM90-100-Z06-A32R-TD15-C	100	32	50	80	11		6	
ASM90-100-Z08-A32R-TD15-C	100	32	50	80	11		8	
ASM90-125-Z07-A40R-TD15-C	125	40	63	87	11		7	
ASM90-125-Z09-A40R-TD15-C	125	40	63	87	11		9	
ASM90-160-Z08-A40R-TD15	160	40	63	107	11		8	
ASM90-160-Z10-A40R-TD15	160	40	63	107	11		10	
ASM90-200-Z09-A60R-TD15	200	60	63	140	11		9	
ASM90-250-Z11-A60-TD15-M	250	60	63	180	11		11	

Note: With internal coolant
 Without internal coolant

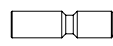
Dimension (mm)	Spare parts		
Cutter diameter	Screw	Wrench	Torque
ø32-250			3.5Nm
	SP040100H	DT-TP15	

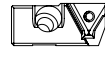
Mounting bolt	Mounting bolt wrench	Cartridge screw	Cartridge screw wrench	Wedge	Wedge screw	Wedge screw wrench	Cartridge
							
WD080300	LT-H4	ACH622	LT-H5	AWG-6H-6	AWCH624	LT-H3	C-TD1540-62-90

Product code	Dimension (mm)		P		M	K		N
	Corner radius	Wiper length	AP251U	AP351M	AP403M	AC301K	AP251K	AW100K
TDMT 150508R-MM4	0.8	1.49	●	●	●	▲	●	
TDMT 150512R-MM4	1.2	1	●	●	●	▲	●	
TDMT 150516R-MM4	1.6	0.93	●	●	●	▲	●	
TDMT 150520R-MM4	2	0.71	●		●		●	
TDMT 150524R-MM4	2.4	0.59	●		●		●	
TDMT 150531R-MM4	3.1	0.4	●		●		●	
TDMT 150540R-MM4	4	0.4	●		●		●	
TDMT 150508R-MM3	0.8	1.49	●		●		●	
TDHT 150508R-MM4	0.8	1.5	●				●	

● : Stock available ▲ : Stock available now but will be replaced in the future.

Materials				Cutting depth and feed					
ISO	Material classification	Tensile strength (N/mm ²)	Hardness (HB)	TD.T 1505..					
				ap		fz			
				(mm)					
				min	max	min	max		
P	Unalloyed steel	<600	<180	0.10	11.00	0.08	0.25		
		<950	<280						
	Alloyed steel	700-950	200-280					0.06	0.22
		950-1200	280-355						
		1200-1400	355-415						
M	Duplex stainless steel	778	230			0.06	0.20		
	Austenitic stainless steel	675	200						
	Precipitation-hardening stainless steel	1013	300						
K	Grey cast iron	700	220	0.08	0.25				
	Nodular cast iron	880	260						
	Malleable cast iron	800	250						
N	Aluminum	260	75	0.06	0.30				
	Aluminum alloy	447	130						
S	Fe-based alloy	943	280	0.06	0.18				
	Co-based alloy	1076	320						
	Ni-based alloy	1177	350						
	Ti-alloy	1262	370						
H	Hardened steel	-	50-60HRC	-	-				
	Chilled cast iron	-	55HRC						

*The recommended cutting conditions always refer to general conditions. These cutting conditions should be adjusted according to the practical machine rigidity, tools, workpiece clamping and coolant. Average chip thickness (hm)=fz x sinker.

Milling cutters

ASM90-A012

Square shoulder milling cutter

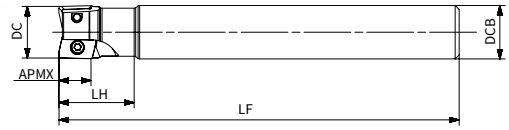
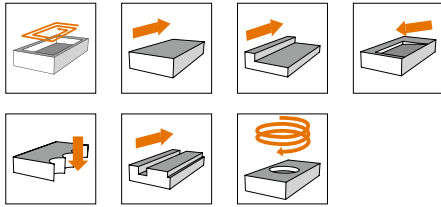

Product code	DC	DCB	LF	LH	APMX	Internal coolant	Z	Inserts
ASM90-020-Z02-C20R-A012-L150-C	20	20	150	28	11		2	AO.T 1204..
ASM90-025-Z03-C25R-A012-L170-C	25	25	170	33	11		3	
ASM90-032-Z04-C32R-A012-L250-C	32	32	250	35	11		4	

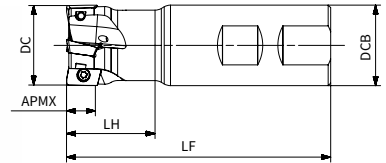

Product code	DC	DCB	LF	LH	APMX	Internal coolant	Z	Inserts
ASM90-020-Z02-W20R-A012-C	20	20	85	30	11		2	AO.T 1204..
ASM90-025-Z03-W20R-A012-C	25	20	95	35	11		3	
ASM90-032-Z04-W32R-A012-C	32	32	105	40	11		4	
ASM90-040-Z04-W32R-A012-C	40	32	120	45	11		4	

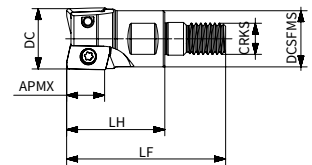

Product code	DC	LF	LH	CRKS	DCSFMS	APMX	Internal coolant	Z	Inserts
ASM90-020-Z02-M10R-A012-C	20	51	31	M10	18	11		2	AO.T 1204..
ASM90-025-Z03-M12R-A012-C	25	59	37	M12	23	11		3	
ASM90-032-Z04-M16R-A012-C	32	72	48	M16	29	11		4	
ASM90-035-Z04-M16R-A012-C	35	72	48	M16	29	11		4	

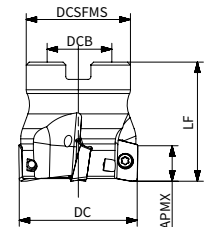
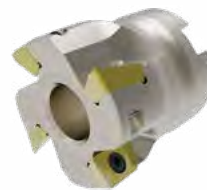

Product code	DC	DCB	LF	DCSFMS	APMX	Internal coolant	Z	Inserts
ASM90-040-Z04-A16R-A012-C	40	16	40	35	11		4	AO.T 1204..
ASM90-050-Z05-A22R-A012-C	50	22	40	42	11		5	
ASM90-050-Z07-A22R-A012-C	50	22	40	42	11		7	
ASM90-063-Z06-A22R-A012-C	63	22	40	48	11		6	
ASM90-063-Z08-A22R-A012-C	63	22	40	48	11		8	
ASM90-080-Z07-A27R-A012-C	80	27	50	62	11		7	
ASM90-080-Z10-A27R-A012-C	80	27	50	62	11		10	

Note: With internal coolant
 Without internal coolant

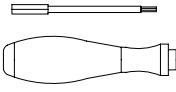
Dimension (mm)	Spare parts		
Cutter diameter	Screw	Wrench	Torque
∅20-32	SP035078		4.0Nm
∅40-80	SP035086	DT-TP10	

Product code	Dimension (mm)		P		M	K		S
	Corner radius	Wiper length	AP251U	AP351M	AP403M	AC301K	AP251K	AP403S
AOGU 120408ER-MM3	0.8	-	●	●	●			●
AOMT 120408ER-MM4	0.8	1.56	●	●	●		●	●
AOMT 120412ER-MM4	1.2	1.18		●	●			●
AOMT 120416ER-MM4	1.6	1.16		●	●			●
AOMT 120420ER-MM4	2.0	0.96	●	●	●			●
AOMT 120424ER-MM4	2.4	0.93	●	●	●			●
AOMT 120431ER-MM4	3.1	0.59		●	●			●
AOMT 120440ER-MM4	4.0	0.75		●	●			●

●: Stock available ▲: Stock available now but will be replaced in the future.

Materials				Cutting depth and feed					
ISO	Material classification	Tensile strength (N/mm ²)	Hardness (HB)	A.O.T 1204..					
				ap		fz			
				(mm)					
				min	max	min	max		
P	Unalloyed steel	<600	<180	0.10	11.00	0.08	0.25		
		<950	<280						
	Alloyed steel	700-950	200-280					0.06	0.22
		950-1200	280-355						
		1200-1400	355-415						
M	Duplex stainless steel	778	230			0.06	0.20		
	Austenitic stainless steel	675	200						
	Precipitation-hardening stainless steel	1013	300						
K	Grey cast iron	700	220			0.08	0.25		
	Nodular cast iron	880	260						
	Malleable cast iron	800	250						
N	Aluminum	260	75	0.06	0.30				
	Aluminum alloy	447	130						
S	Fe-based alloy	943	280	0.06	0.18				
	Co-based alloy	1076	320						
	Ni-based alloy	1177	350						
	Ti-alloy	1262	370						
H	Hardened steel	-	50-60HRC	-	-				
	Chilled cast iron	-	55HRC						

*The recommended cutting conditions always refer to general conditions. These cutting conditions should be adjusted according to the practical machine rigidity, tools, workpiece clamping and coolant. Average chip thickness (hm)=fz x sinkr.

APE90-LN09

Square shoulder porcupine milling cutter

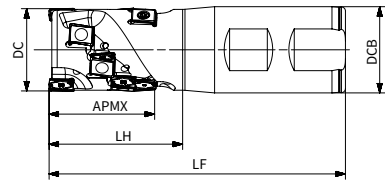
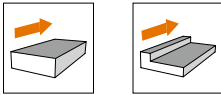

Product code	DC	DCB	LF	LH	APMX	Internal coolant	Z	Row	Insert QTY	Inserts
APE90-025-Z02-W25R-LN09-L32-F-C	25	25	100	43	32		2	4	8	LNHU 0904..
APE90-032-Z02-W32R-LN09-L32-F-C	32	32	105	44	32		2	4	8	
APE90-032-Z02-W32R-LN09-L40-F-C	32	32	110	50	40		2	5	10	
APE90-040-Z03-W40R-LN09-L40-F-C	40	40	125	55	40		3	5	15	
APE90-040-Z03-W40R-LN09-L48-F-C	40	40	130	59	48		3	6	18	

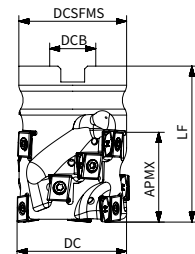
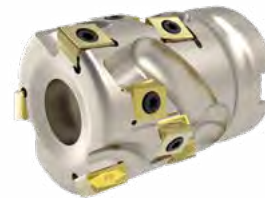

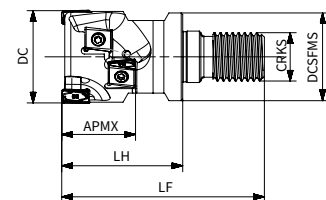

Product code	DC	DCB	LF	DCSFMS	APMX	Internal coolant	Clamping screw	Z	Row	Insert QTY	Inserts
APE90-040-Z03-A16R-LN09-L32-F-C	40	16	55	38	32		SH080400	3	4	12	LNHU 0904..
APE90-040-Z03-A16R-LN09-L40-F-C	40	16	65	38	40		SH080500	3	5	15	
APE90-050-Z04-A22R-LN09-L48-F-C	50	22	75	47.5	48		SH100550	4	6	24	

Clamping screw	Product code	Screw type	Clamping torque
	SH080400	M8*40	41Nm
	SH080500	M8*50	41Nm
	SH100550	M10*55	81Nm

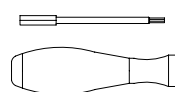

Product code	DC	LF	LH	CRKS	DCSFMS	APMX	Internal coolant	Z	Row	Insert QTY	Inserts
APE90-025-Z02-M12R-LN09-L24-F-C	25	64	40	M12	23	24		2	3	6	LNHU 0904..
APE90-032-Z02-M16R-LN09-L24-F-C	32	67	40	M16	30	24		2	3	6	
APE90-032-Z02-M16R-LN09-L32-F-C	32	77	50	M16	30	32		2	4	8	

Note: With internal coolant
 Without internal coolant

Dimension (mm)	Spare parts			
Cutter diameter	Screw	Wrench	Wrench	Torque
ø25-50				1.8Nm
	SP030083	DT-TP09	AFW-15/24	

Product code	Dimension (mm)		P			M	K	N	
	Corner radius	Wiper length	AP251U	AP351U	AP351M	AP403M	AC301K	AP251K	AW100K
LNHU 090404ER-FM2	0.4	1.85							●
LNHU 090404ER-MM3	0.4	1.85		▲		●			
LNHU 090404ER-MR2	0.4	1.85	●	▲		●	▲	●	
LNHU 090404ER-MM4	0.4	1.85	●		●	●		●	
LNHU 090408ER-MM4	0.8	1.3	●		●	●		●	
LNHU 090408ER-MR2	0.8	1.3	●	▲		●	▲	●	
LNHU 090408ER-MM3	0.8	1.3	●		●	●		●	
LNHU 090412ER-MR2	1.2	1.0	●			●	▲		
LNHU 090416ER-MR2	1.6	0.65	●			●	▲		
LNHU 090420ER-MR2	2.0	0.65	●			●	▲		
LNHU 0904PDER-W	0.4	3.6	●					●	

●: Stock available ▲: Stock available now but will be replaced in the future.

Materials				Cutting depth and feed							
ISO	Material classification	Tensile strength (N/mm ²)	Hardness (HB)	LNHU..0904..							
				ap		MM3		MR2		FM2	
				fz							
				(mm)							
		min	max	min	max	min	max	min	max		
P	Unalloyed steel	<600	<180	0.20	48.00	0.06	0.22	0.08	0.25	-	-
		<950	<280			0.05	0.18	0.06	0.20	-	-
	Alloyed steel	700-950	200-280			0.05	0.18	0.06	0.18	-	-
		950-1200	280-355			0.05	0.18	0.06	0.18	-	-
	1200-1400	355-415	0.05			0.18	0.06	0.18	-	-	
M	Duplex stainless steel	778	230			0.05	0.18	0.06	0.18	-	-
	Austenitic stainless steel	675	200			0.05	0.18	0.06	0.18	-	-
	Precipitation-hardening stainless steel	1013	300			0.05	0.18	0.06	0.18	-	-
K	Grey cast iron	700	220			0.05	0.22	0.08	0.25	-	-
	Nodular cast iron	880	260			0.05	0.22	0.08	0.25	-	-
	Malleable cast iron	800	250			0.05	0.22	0.08	0.25	-	-
N	Aluminum	260	75			-	-	-	-	0.06	0.25
	Aluminum alloy	447	130	-	-	-	-	0.06	0.25		
S	Fe-based alloy	943	280	0.05	0.15	-	-	-	-		
	Co-based alloy	1076	320	0.05	0.15	-	-	-	-		
	Ni-based alloy	1177	350	0.05	0.15	-	-	-	-		
	Ti-alloy	1262	370	0.05	0.15	-	-	-	-		
H	Hardened steel	-	50-60HRC	-	-	0.05	0.12	-	-		
	Chilled cast iron	-	55HRC	-	-	0.05	0.12	-	-		

*The recommended cutting conditions always refer to general conditions. These cutting conditions should be adjusted according to the practical machine rigidity, tools, workpiece clamping and coolant. Average chip thickness (hm)=fz x sinkr.

APE90-LN13

Square shoulder porcupine milling cutter

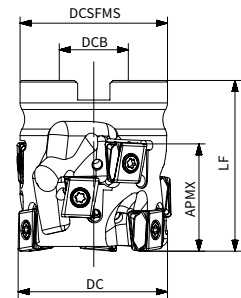
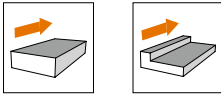

Product code	DC	DCB	LF	DCSFMS	APMX	Internal coolant	Clamping screw	Z	Row	Insert QTY	Inserts
APE90-040-Z02-A16R-LN13-L34-F-C	40	16	55	39	34		SH100400	2	3	6	LNHU 1306..
APE90-040-Z02-A16R-LN13-L45-F-C	40	16	65	39	45		SH100450	2	4	8	
APE90-050-Z03-A22R-LN13-L34-F-C	50	22	55	47.5	34		SH100400	3	3	9	
APE90-050-Z03-A22R-LN13-L45-F-C	50	22	65	47.5	45		SH100450	3	4	12	
APE90-063-Z04-A27R-LN13-L56-F-C	63	27	80	59.5	56		SH120600	4	5	20	
APE90-063-Z04-A27R-LN13-L45-F-C	63	27	70	59.5	45		SH120500	4	4	16	
APE90-080-Z05-A32R-LN13-L56-F-C	80	32	85	75.6	56		SH160650	5	5	25	

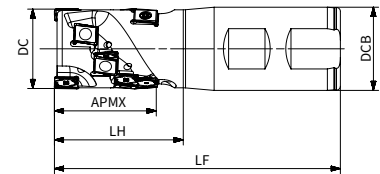

Product code	DC	DCB	LF	LH	APMX	Internal coolant	Z	Row	Insert QTY	Inserts
APE90-040-Z02-W40R-LN13-L34-F-C	40	40	120	54	34		2	3	6	LNHU 1306..
APE90-040-Z02-W40R-LN13-L45-F-C	40	40	135	64	45		2	4	8	

Clamping screw	Product code	Screw type	Clamping torque
	SH080400	M8*40	41N-m
	SH080500	M8*50	41N-m
	SH100550	M10*55	81N-m
	SH100400	M10*40	81N-m
	SH100450	M10*45	81N-m
	SH120500	M12*50	142N-m
	SH120600	M12*60	142N-m
	SH160650	M16*65	350N-m

Dimension (mm)	Spare parts		
Cutter diameter	Screw	Wrench	Torque
ø40-80			3.5Nm
	SP040115	DT-TP15	

Note: With internal coolant
 Without internal coolant

Product code	Dimension (mm)		P			M	K		N
	Corner radius	Wiper length	AP251U	AP351U	AP351M	AP403M	AC301K	AP251K	AW100K
LNHU 130608ER-FM2	0.8	2.7							●
LNHU 130608ER-MM3	0.8	2.7		▲		●			
LNHU 130608ER-MM4	0.8	2.7	●		●	●		●	
LNHU 130608ER-MR2	0.8	2.7	●	▲	●	●	▲	●	
LNHU 130612ER-MM4	1.2	2.3	●		●	●		●	
LNHU 130612ER-MR2	1.2	2.3	●	▲	●	●	▲	●	
LNHU 130616ER-MR2	1.6	1.9	●	▲	●	●		●	
LNHU 130620ER-MR2	2.0	1.5		▲	●	●	▲		
LNHU 130624ER-MR2	2.4	1.0		▲	●	●	▲		
LNHU 130631ER-MR2	3.1	0.4		▲	●	●	▲		
LNHU 1306PDR-W	0.8	5.6	●					●	

●: Stock available ▲: Stock available now but will be replaced in the future.

Materials				Cutting depth and feed							
ISO	Material classification	Tensile strength (N/mm ²)	Hardness (HB)	LNHU..1306..							
				ap		MM3		MR2		FM2	
						fz					
								(mm)			
		min	max	min	max	min	max	min	max		
P	Unalloyed steel	<600	<180	0.30	85	0.10	0.28	0.10	0.30	-	-
		<950	<280								
	Alloyed steel	700-950	200-280			0.08	0.25	0.08	0.28	-	-
		950-1200	280-355								
	1200-1400	355-415									
M	Duplex stainless steel	778	230								
	Austenitic stainless steel	675	200			0.08	0.22	0.08	0.25	-	-
	Precipitation-hardening stainless steel	1013	300								
K	Grey cast iron	700	220								
	Nodular cast iron	880	260			-	-	0.10	0.32	-	-
	Malleable cast iron	800	250								
N	Aluminum	260	75							0.08	0.30
	Aluminum alloy	447	130								
S	Fe-based alloy	943	280								
	Co-based alloy	1076	320								
	Ni-based alloy	1177	350	0.06	0.18	0.08	0.22	-	-		
	Ti-alloy	1262	370								
H	Hardened steel	-	50-60HRC								
	Chilled cast iron	-	55HRC								

*The recommended cutting conditions always refer to general conditions. These cutting conditions should be adjusted according to the practical machine rigidity, tools, workpiece clamping and coolant. Average chip thickness (hm)=fz x sinkr.

AHM15-XD09

15° Approaching angle high feed milling cutter

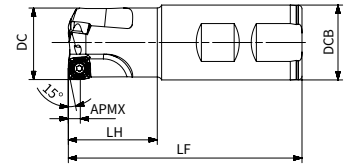
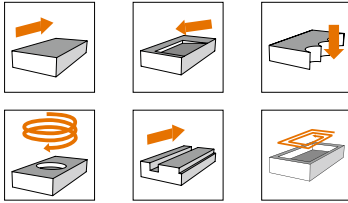

Product code	DC	DCB	LF	LH	APMX	Internal coolant	Z	Inserts
AHM15-025-Z02-W25R-XD09-C	25	25	96	38	1.5		2	XD..0904..
AHM15-032-Z03-W32R-XD09-C	32	32	100	38	1.5		3	

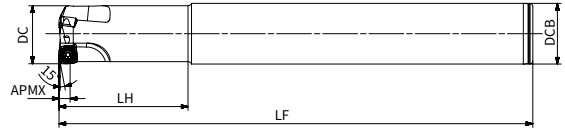

Product code	DC	DCB	LF	LH	APMX	Internal coolant	Z	Inserts
AHM15-025-Z02-C25R-XD09-C	25	25	200	49	1.5		2	XD..0904..
AHM15-026-Z02-C25R-XD09-L180-C	26	25	180	29	1.5		2	
AHM15-032-Z03-C32R-XD09-C	32	32	250	69	1.5		3	

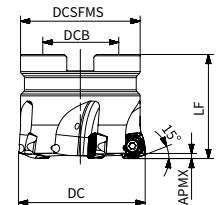

Product code	DC	DCB	DCSFMS	LF	APMX	Internal coolant	Z	Inserts
AHM15-040-Z03-A16R-XD09-C	40	16	35	32	1.5		3	XD..0904..
AHM15-040-Z04-A16R-XD09-C	40	16	35	32	1.5		4	
AHM15-040-Z05-A16R-XD09-C	40	16	35	32	1.5		5	
AHM15-050-Z05-A22R-XD09-C	50	22	46	40	1.5		5	
AHM15-050-Z06-A22R-XD09-C	50	22	46	40	1.5		6	

Dimension (mm)	Spare parts		
Cutter diameter	Screw	Wrench	Torque
Ø25-50			3.0Nm
	SP035086	DT-TP10	

Note: With internal coolant
 Without internal coolant

Product code	Dimension (mm)		P			M	K		S
	Corner radius	Wiper length	AP251U	AP351U	AC301P	AP403M	AC301K	AP251K	AP403S
XDLT 090408ER-MM3	0.8	1.3	●	▲	▲		▲		●
XDMW 090408ER-HR2	0.8	1.3					▲		

●: Stock available ▲: Stock available now but will be replaced in the future.

Materials				Depth(width) of cut and feed rate															
ISO	Material classification	Tensile strength (N/mm ²)	Hardness (HB)	XD..0904..															
				High feed milling				Plunging											
				ap		fz		ae		fz									
				(mm)															
				min	max	min	max	min	max	min	max								
P	Unalloyed steel	<600	<180	0.20	1.50	0.30	1.50	0.00	7.00	0.05	0.15								
		<950	<280																
	Alloyed steel	700-950	200-280									0.30	1.50	0.05	0.12				
		950-1200	280-355																
		1200-1400	355-415																
M	Duplex stainless steel	778	230									0.20	1.50	0.30	1.50	0.00	7.00	0.05	0.10
	Austenitic stainless steel	675	200																
	Precipitation-hardening stainless steel	1013	300																
K	Grey cast iron	700	220									0.20	1.50	0.30	1.50	0.00	7.00	0.05	0.15
	Nodular cast iron	880	260																
	Malleable cast iron	800	250																
N	Aluminum	260	75	0.20	1.50	-	-	0.00	7.00	-	-								
	Aluminum alloy	447	130																
S	Fe-based alloy	943	280	0.20	1.50	0.10	0.50	0.00	7.00	0.05	0.10								
	Co-based alloy	1076	320																
	Ni-based alloy	1177	350																
	Ti-alloy	1262	370																
H	Hardened steel	-	50-60HRC	0.20	1.50	0.30	1.00	0.00	7.00	0.05	0.10								
	Chilled cast iron	-	55HRC																

*The recommended cutting conditions always refer to general conditions. These cutting conditions should be adjusted according to the practical machine rigidity, tools, workpiece clamping and coolant. Average chip thickness (hm)=fz x sinkr.

Milling cutters

AHM15-XD12

15° Approaching angle high feed milling cutter

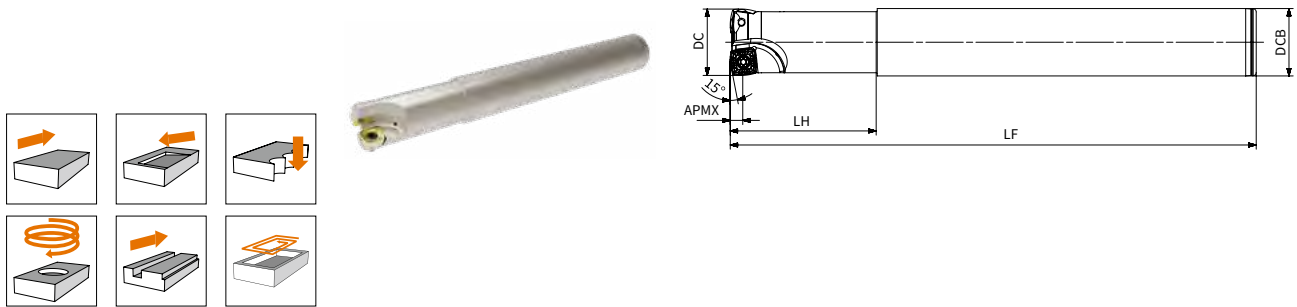

Product code	DC	DCB	LF	LH	APMX	Internal coolant	Z	Inserts
AHM15-032-Z02-C32R-XD12-C	32	32	250	70	2.5		2	XD..1205..

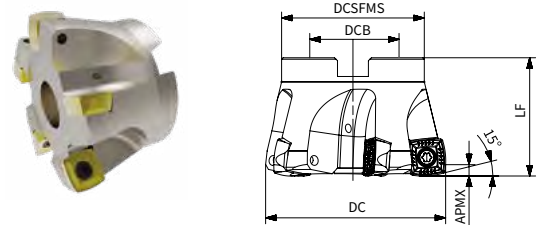

Product code	DC	DCB	DCSFMS	LF	APMX	Internal coolant	Z	Inserts
AHM15-052-Z03-A22R-XD12-C	52	22	45	40	2.5		3	XD..1205..
AHM15-052-Z04-A22R-XD12-C	52	22	45	40	2.5		4	
AHM15-052-Z05-A22R-XD12-C	52	22	45	40	2.5		5	
AHM15-063-Z04-A22R-XD12-C	63	22	48	40	2.5		4	
AHM15-063-Z05-A22R-XD12-C	63	22	48	40	2.5		5	
AHM15-063-Z04-60A22R-XD12-C	63	22	60	40	2.5		4	
AHM15-063-Z05-60A22R-XD12-C	63	22	60	40	2.5		5	
AHM15-066-Z04-A27R-XD12-C	66	27	50	45	2.5		4	
AHM15-066-Z05-A27R-XD12-C	66	27	50	45	2.5		5	
AHM15-066-Z04-63A27R-XD12-C	66	27	63	45	2.5		4	
AHM15-066-Z05-63A27R-XD12-C	66	27	63	45	2.5		5	
AHM15-080-Z05-A27R-XD12-C	80	27	55	50	2.5		5	
AHM15-080-Z08-A27R-XD12-C	80	27	55	50	2.5		8	
AHM15-080-Z05-76A27R-XD12-C	80	27	76	50	2.5		5	
AHM15-080-Z08-76A27R-XD12-C	80	27	76	50	2.5		8	
AHM15-100-Z06-A32R-XD12-C	100	32	80	50	2.5		6	
AHM15-100-Z09-A32R-XD12-C	100	32	80	50	2.5		9	
AHM15-100-Z06-96A32R-XD12-C	100	32	96	50	2.5		6	
AHM15-100-Z09-96A32R-XD12-C	100	32	96	50	2.5		9	
AHM15-125-Z08-A40R-XD12-C	125	40	89	63	2.5		8	
AHM15-125-Z11-A40R-XD12-C	125	40	89	63	2.5		11	
AHM15-125-Z08-100A40R-XD12-C	125	40	100	63	2.5		8	
AHM15-125-Z11-100A40R-XD12-C	125	40	100	63	2.5		11	

Note: With internal coolant
 Without internal coolant

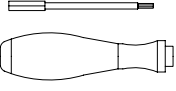
Dimension (mm)	Spare parts		
Cutter diameter	Screw	Wrench	Torque
ø32-125			3.5Nm
	SP040112	DT-TP15	

Product code	Dimension (mm)		P			M	K		N
	Corner radius	Wiper length	AP251U	AP351U	AC301P	AP403M	AC301K	AP251K	AW100K
XDLT 120508ER-MM3	0.8	2.2	●	▲	▲		▲	●	●
XDLT 120512ER-MM3	1.2	2.2	●	▲	▲		▲	●	
XDMW 120508ER-HR2	0.8	2.2	●				▲		

●: Stock available ▲: Stock available now but will be replaced in the future.

Materials				Depth(width) of cut and feed rate											
ISO	Material classification	Tensile strength (N/mm ²)	Hardness (HB)	XD..1205..											
				High feed milling			Plunging								
				ap		fz		ae		fz					
				(mm)											
min		max		min		max		min		max					
P	Unalloyed steel	<600	<180	0.50	2.50	0.30	2.00	0.00	10.00	0.06	0.18				
		<950	<280												
	Alloyed steel	700-950	200-280									0.30	2.00	0.06	0.15
		950-1200	280-355												
M	Duplex stainless steel	778	230			0.20	1.00			0.06	0.12				
	Austenitic stainless steel	675	200												
	Precipitation-hardening stainless steel	1013	300									0.10	0.60	0.05	0.10
K	Grey cast iron	700	220			0.30	2.00			0.06	0.18				
	Nodular cast iron	880	260												
	Malleable cast iron	800	250												
N	Aluminum	260	75			-	-			-	-				
	Aluminum alloy	447	130												
S	Fe-based alloy	943	280	0.30	2.00	0.05	0.12								
	Co-based alloy	1076	320												
	Ni-based alloy	1177	350												
	Ti-alloy	1262	370												
H	Hardened steel	-	50-60HRC	0.30	1.00	0.05	0.12								
	Chilled cast iron	-	55HRC												

*The recommended cutting conditions always refer to general conditions. These cutting conditions should be adjusted according to the practical machine rigidity, tools, workpiece clamping and coolant. Average chip thickness (hm)=fz x sinker.

APM00-RP

Profile milling

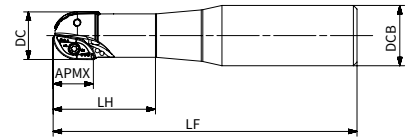
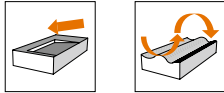

Product code	DC	DCB	LF	LH	APMX	Internal coolant	Z	Inserts
APM00-016-Z02-C20R-RP080-L120-C	16	20	120	35	14		2	RPM 080ER-MM4
APM00-020-Z02-C25R-RP100-L126-C	20	25	126	43	18		2	RPM 100ER-MM4
APM00-020-Z02-C25R-RP100-L176-C	20	25	176	43	18		2	

APM00-RP

Profile milling

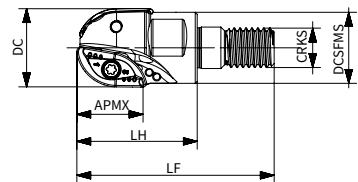

Product code	DC	LF	LH	CRKS	DCSFMS	APMX	Internal coolant	Z	Inserts
APM00-016-Z02-M10R-RP080-C	16	49	28	M10	15	14		2	RPM 080ER-MM4
APM00-020-Z02-M10R-RP100-C	20	50	30	M10	15	18		2	RPM 100ER-MM4

Dimension (mm)	Spare parts			
Cutter diameter	Screw	Wrench	Wrench	Torque
Ø16				1.8Nm
	SP02506450H	DT-TP08		
Ø20	SP030072H	DT-TP09	AFW-15	

Note: With internal coolant
 Without internal coolant

Product code	Dimension (mm)		P		M		K	S
	Corner radius	Wiper length	AP251U	AP351U	AP401U	AP351M	AP351K	AP403S
RPM 080ER-MM4	8	-	●	▲	●	●		●
RPM 100ER-MM4	10	-	●	▲	●	●		●

●: Stock available ▲: Stock available now but will be replaced in the future.

Milling cutters

Materials				Cutting depth and feed					
ISO	Material classification	Tensile strength (N/mm ²)	Hardness (HB)	RPM....					
				ap		MM4			
				(mm)					
				min	max	min	max		
P	Unalloyed steel	<600	<180	0.20	15.00	0.10	0.20		
		<950	<280						
	Alloyed steel	700-950	200-280					0.10	0.18
		950-1200	280-355						
M	Duplex stainless steel	778	230			0.10	0.18		
	Austenitic stainless steel	675	200						
	Precipitation-hardening stainless steel	1013	300						
K	Grey cast iron	700	220			-	-		
	Nodular cast iron	880	260						
	Malleable cast iron	800	250						
N	Aluminum	260	75	-	-				
	Aluminum alloy	447	130						
S	Fe-based alloy	943	280	0.06	0.12				
	Co-based alloy	1076	320						
	Ni-based alloy	1177	350						
	Ti-alloy	1262	370						
H	Hardened steel	-	50-60HRC	-	-				
	Chilled cast iron	-	55HRC						

*The recommended cutting conditions always refer to general conditions. These cutting conditions should be adjusted according to the practical machine rigidity, tools, workpiece clamping and coolant. Average chip thickness (hm)=fz x sinkr.

APM00-RO08
Profile milling

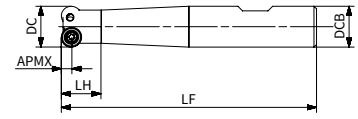
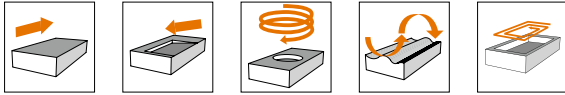

Product code	DC	DCB	LF	LH	APMX	Internal coolant	Z	Inserts
APM00-016-Z02-W16R-RO08-L100	16	16	100	15.6	4		2	RO..0803..

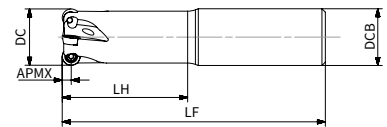

Product code	DC	DCB	LF	LH	APMX	Internal coolant	Z	Inserts
APM00-025-Z04-C25R-RO08-L116-C	25	25	116	55.3	4		4	RO..0803..

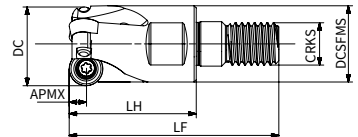

Product code	DC	CRKS	DCSFMS	LF	LH	APMX	Internal coolant	Z	Inserts
APM00-020-Z03-M10R-RO08-C	20	M10	18	49.5	30	4		3	RO..0803..

Dimension (mm)	Spare parts		
Cutter diameter	Screw	Wrench	Torque
Ø16-25			2.0Nm
	SP030072H	DT-TP09	

Note: With internal coolant
 Without internal coolant

Product code	Dimension (mm)		P			M	K		S
	IC	S	AP251U	AP351U	AC301P	AP403M	AC301K	AP251K	AP403S
ROHT 0803MOE-MM3	8	3.18				●			●

●: Stock available ▲: Stock available now but will be replaced in the future.

Materials				Cutting depth and feed						
ISO	Material classification	Tensile strength (N/mm ²)	Hardness (HB)	RO..0803..						
				MM3						
				ap	fz					
					0.1 < ap ≤ 1		1 < ap ≤ 4			
				(mm)						
min	max	min	max	min	max					
P	Unalloyed steel	<600	<180	0.50	4.00	0.15	0.50	0.08	0.30	
		<950	<280							
	Alloyed steel	700-950	200-280			0.12	0.45	0.06	0.28	
		950-1200	280-355							
1200-1400		355-415								
M	Duplex stainless steel	778	230							
	Austenitic stainless steel	675	200			0.10	0.40	0.06	0.25	
	Precipitation-hardening stainless steel	1013	300							
K	Grey cast iron	700	220							
	Nodular cast iron	880	260			-	-	-	-	
	Malleable cast iron	800	250							
N	Aluminum	260	75							
	Aluminum alloy	447	130			0.10	0.35	0.06	0.25	
S	Fe-based alloy	943	280							
	Co-based alloy	1076	320							
	Ni-based alloy	1177	350							
	Ti-alloy	1262	370							
H	Hardened steel	-	50-60HRC							
	Chilled cast iron	-	55HRC							

*The recommended cutting conditions always refer to general conditions. These cutting conditions should be adjusted according to the practical machine rigidity, tools, workpiece clamping and coolant. Average chip thickness (hm)=fz x sinker.

Milling cutters

APM00-RO10
Profile milling

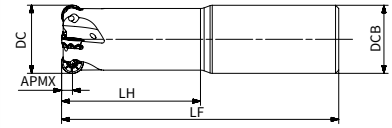
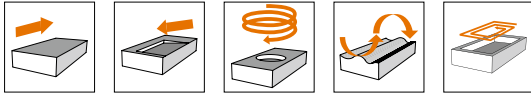

Product code	DC	DCB	LF	LH	APMX	Internal coolant	Z	Inserts
APM00-025-Z03-C25R-RO10-L225-C	25	25	225	56.2	5		3	R0..10T3..
APM00-032-Z04-C32R-RO10-L130-C	32	32	130	65	5		4	R0..10T3..

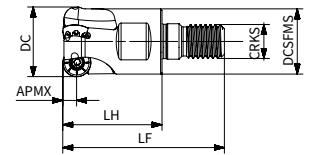

Product code	DC	CRKS	DCSFMS	LF	LH	APMX	Internal coolant	Z	Inserts
APM00-025-Z03-M12R-RO10-C	25	M12	23	59	35	5		3	R0..10T3..
APM00-032-Z04-M16R-RO10-C	32	M16	29	70	43	5		4	R0..10T3..

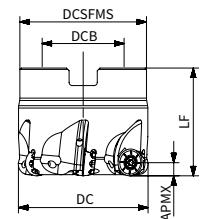

Product code	DC	DCB	DCSFMS	LF	APMX	Internal coolant	Z	Inserts
APM00-040-Z05-A16R-RO10-C	40	16	35	40	5		5	R0..10T3..
APM00-050-Z06-A22R-RO10-C	50	22	47	40	5		6	R0..10T3..

Dimension (mm)	Spare parts		
Cutter diameter	Screw	Wrench	Torque
ø25-50			2.0Nm
	SP030072H	DT-TP09	

Note: With internal coolant
 Without internal coolant

Product code	Dimension (mm)		P			M	K		S
	IC	S	AP251U	AP351U	AC301P	AP403M	AC301K	AP251K	AP403S
ROHT 10T3M8E-MM3	10	3.97				●			●
ROMT 10T3M4E-MR6	10	3.97				●			●

●: Stock available ▲: Stock available now but will be replaced in the future.

Materials				Cutting depth and feed										
ISO	Material classification	Tensile strength (N/mm ²)	Hardness (HB)	RO..10T3..										
				ap	MM3				MR6					
					fz		fz		fz		fz			
					0.1 < ap ≤ 1.2	1.2 < ap ≤ 5	0.1 < ap ≤ 1.2	1.2 < ap ≤ 5	0.1 < ap ≤ 1.2	1.2 < ap ≤ 5	0.1 < ap ≤ 1.2	1.2 < ap ≤ 5		
(mm)														
min		max		min		max		min		max				
P	Unalloyed steel	<600	<180	0.80	5.00	0.15	0.55	0.10	0.30	0.15	0.60	0.10	0.32	
		<950	<280			0.12	0.50	0.08	0.28	0.12	0.55	0.08	0.30	
	Alloyed steel	700-950	200-280			0.10	0.45	0.08	0.25	0.10	0.50	0.08	0.28	
		950-1200	280-355			-	-	-	-	-	-	-	-	-
1200-1400	355-415	-	-			-	-	-	-	-	-	-		
M	Duplex stainless steel	778	230			-	-	-	-	-	-	-	-	-
	Austenitic stainless steel	675	200			-	-	-	-	-	-	-	-	-
	Precipitation-hardening stainless steel	1013	300			-	-	-	-	-	-	-	-	-
K	Grey cast iron	700	220			-	-	-	-	-	-	-	-	-
	Nodular cast iron	880	260			-	-	-	-	-	-	-	-	-
	Malleable cast iron	800	250			-	-	-	-	-	-	-	-	-
N	Aluminum	260	75			-	-	-	-	-	-	-	-	-
	Aluminum alloy	447	130	-	-	-	-	-	-	-	-	-		
S	Fe-based alloy	943	280	0.10	0.40	0.08	0.25	-	-	-	-	-		
	Co-based alloy	1076	320	-	-	-	-	-	-	-	-	-		
	Ni-based alloy	1177	350	-	-	-	-	-	-	-	-	-		
	Ti-alloy	1262	370	-	-	-	-	-	-	-	-	-		
H	Hardened steel	-	50-60HRC	-	-	-	-	-	-	-	-	-		
	Chilled cast iron	-	55HRC	-	-	-	-	-	-	-	-	-		

*The recommended cutting conditions always refer to general conditions. These cutting conditions should be adjusted according to the practical machine rigidity, tools, workpiece clamping and coolant. Average chip thickness (hm)=fz x sinkr.

Milling cutters

APM00-R012
Profile milling

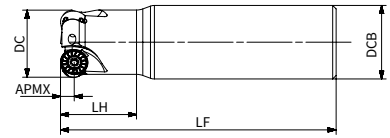
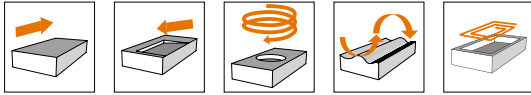

Product code	DC	DCB	LF	LH	APMX	Internal coolant	Z	Inserts
APM00-032-Z03-C32R-R012-L120-C	32	32	120	33	6		3	RO..1204..

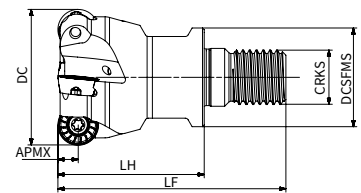

Product code	DC	CRKS	DCSFMS	LF	LH	APMX	Internal coolant	Z	Inserts
APM00-040-Z04-M16R-R012-C	40	M16	29	70	43	6		4	RO..1204..

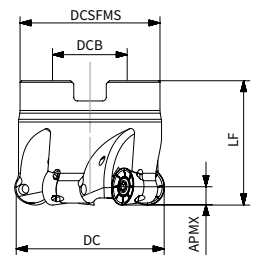

Product code	DC	DCB	DCSFMS	LF	APMX	Internal coolant	Z	Inserts
APM00-040-Z04-A16R-R012-C	40	16	35	40	6		4	RO..1204..
APM00-050-Z05-A22R-R012-C	50	22	45	40	6		5	
APM00-063-Z06-A22R-R012-C	63	22	48	40	6		6	
APM00-080-Z07-A27R-R012-C	80	27	62	50	6		7	

Dimension (mm)	Spare parts		
Cutter diameter	Screw	Wrench	Torque
ø32-80			4.0Nm
	SP040085H	DT-TP10	

Note: With internal coolant
 Without internal coolant

Product code	Dimension (mm)		P			M	K		S
	IC	S	AP251U	AP351U	AC301P	AP403M	AC301K	AP251K	AP403S
ROHT 1204M4E-MM3	12	4.76				●			●
ROHT 1204M6E-MM3	12	4.76				●			●
ROMT 1204M6E-MR6	12	4.76				●			●

●: Stock available ▲: Stock available now but will be replaced in the future.

Materials				Cutting depth and feed										
ISO	Material classification	Tensile strength (N/mm ²)	Hardness (HB)	RO..1204..										
				ap	MM3				MR6					
					fz									
					0.1 < ap ≤ 1.5		1.5 < ap ≤ 6		0.1 < ap ≤ 1.5		1.5 < ap ≤ 6			
(mm)														
min		max		min		max		min		max				
P	Unalloyed steel	<600	<180	0.80	6.00	0.18	0.60	0.12	0.32	0.18	0.65	0.12	0.35	
		<950	<280			0.15	0.55	0.10	0.30	0.15	0.60	0.10	0.32	
	Alloyed steel	700-950	200-280			0.12	0.50	0.10	0.28	0.12	0.55	0.10	0.30	
		950-1200	280-355			-	-	-	-	-	-	-	-	
1200-1400	355-415	-	-			-	-	-	-	-	-			
M	Duplex stainless steel	778	230			-	-	-	-	-	-	-	-	-
	Austenitic stainless steel	675	200			-	-	-	-	-	-	-	-	-
	Precipitation-hardening stainless steel	1013	300			-	-	-	-	-	-	-	-	-
K	Grey cast iron	700	220			-	-	-	-	-	-	-	-	-
	Nodular cast iron	880	260			-	-	-	-	-	-	-	-	-
	Malleable cast iron	800	250			-	-	-	-	-	-	-	-	-
N	Aluminum	260	75			-	-	-	-	-	-	-	-	-
	Aluminum alloy	447	130	-	-	-	-	-	-	-	-	-		
S	Fe-based alloy	943	280	0.12	0.45	0.10	0.28	-	-	-	-	-		
	Co-based alloy	1076	320	-	-	-	-	-	-	-	-	-		
	Ni-based alloy	1177	350	-	-	-	-	-	-	-	-	-		
	Ti-alloy	1262	370	-	-	-	-	-	-	-	-	-		
H	Hardened steel	-	50-60HRC	-	-	-	-	-	-	-	-	-		
	Chilled cast iron	-	55HRC	-	-	-	-	-	-	-	-	-		

*The recommended cutting conditions always refer to general conditions. These cutting conditions should be adjusted according to the practical machine rigidity, tools, workpiece clamping and coolant. Average chip thickness (hm)=fz x sinkr.

Milling cutters

APM00-R016
Profile milling

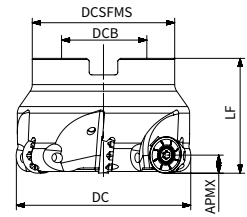
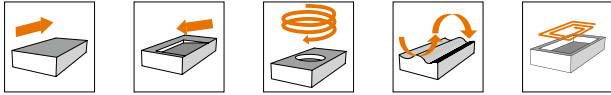

Product code	DC	DCB	DCSFMS	LF	APMX	Internal coolant	Z	Inserts
APM00-063-Z05-A22R-R016-C	63	22	48	40	8		5	RO..1605..
APM00-080-Z06-A27R-R016-C	80	27	62	50	8		6	
APM00-100-Z07-A32R-R016-C	100	32	80	50	8		7	

Dimension (mm)	Spare parts		
Cutter diameter	Screw	Wrench	Torque
ø63-100			5.0Nm
	SP050120	DT-TP20	

Note: With internal coolant
 Without internal coolant

Product code	Dimension (mm)		P			M	K		S
	IC	S	AP251U	AP351U	AC301P	AP403M	AC301K	AP251K	AP403S
ROHT 1605M8E-MM3	16	5.56				●			●
ROMT 1605M6E-MR6	16	5.56				●			●

●: Stock available ▲: Stock available now but will be replaced in the future.

Materials				Cutting depth and feed										
ISO	Material classification	Tensile strength (N/mm ²)	Hardness (HB)	RO..1605..										
				ap	MM3				MR6					
					fz									
					0.1 < ap ≤ 1.5		1.5 < ap ≤ 8		0.1 < ap ≤ 1.5		1.5 < ap ≤ 8			
(mm)														
min		max		min		max		min		max				
P	Unalloyed steel	<600	<180	0.80	8.00	0.20	0.65	0.12	0.35	0.20	0.68	0.12	0.38	
		<950	<280			0.18	0.60	0.10	0.32	0.18	0.65	0.10	0.35	
	Alloyed steel	700-950	200-280			0.15	0.55	0.10	0.30	0.15	0.58	0.10	0.32	
		950-1200	280-355			-	-	-	-	-	-	-	-	-
1200-1400	355-415	-	-			-	-	-	-	-	-	-		
M	Duplex stainless steel	778	230			-	-	-	-	-	-	-	-	-
	Austenitic stainless steel	675	200			-	-	-	-	-	-	-	-	-
	Precipitation-hardening stainless steel	1013	300			-	-	-	-	-	-	-	-	-
K	Grey cast iron	700	220			-	-	-	-	-	-	-	-	-
	Nodular cast iron	880	260			-	-	-	-	-	-	-	-	-
	Malleable cast iron	800	250			-	-	-	-	-	-	-	-	-
N	Aluminum	260	75			-	-	-	-	-	-	-	-	-
	Aluminum alloy	447	130	-	-	-	-	-	-	-	-	-		
S	Fe-based alloy	943	280	0.15	0.50	0.10	0.30	-	-	-	-	-		
	Co-based alloy	1076	320	-	-	-	-	-	-	-	-	-		
	Ni-based alloy	1177	350	-	-	-	-	-	-	-	-	-		
	Ti-alloy	1262	370	-	-	-	-	-	-	-	-	-		
H	Hardened steel	-	50-60HRC	-	-	-	-	-	-	-	-	-		
	Chilled cast iron	-	55HRC	-	-	-	-	-	-	-	-	-		

*The recommended cutting conditions always refer to general conditions. These cutting conditions should be adjusted according to the practical machine rigidity, tools, workpiece clamping and coolant. Average chip thickness (hm)=fz x sinker.

Milling cutters

APM00-RO20
Profile milling

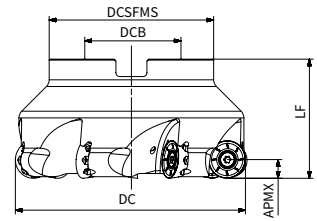
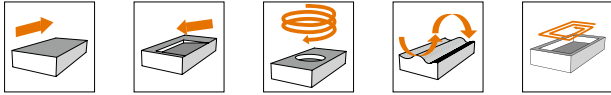

Product code	DC	DCB	DCSFMS	LF	APMX	Internal coolant	Z	Inserts
APM00-100-Z06-A32R-RO20-C	100	32	80	50	10		6	RO..2006..
APM00-125-Z07-A40R-RO20-C	125	40	87	63	10		7	
APM00-160-Z08-A40R-RO20	160	40	107	63	10		8	

Dimension (mm)	Spare parts		
Cutter diameter	Screw	Wrench	Torque
ø100-160			7.0Nm
	ST060180	DT-T25	

Note: With internal coolant
 Without internal coolant

Product code	Dimension (mm)		P			M	K		S
	IC	S	AP251U	AP351U	AC301P	AP403M	AC301K	AP251K	AP403S
ROHT 2006M8E-MM3	20	6.35				●			●
ROMT 2006M8E-MR6	20	6.35				●			●

●: Stock available ▲: Stock available now but will be replaced in the future.

Materials				Cutting depth and feed											
ISO	Material classification	Tensile strength (N/mm ²)	Hardness (HB)	RO..2006..											
				ap	MM3				MR6						
					fz										
					0.1 < ap ≤ 2.5		2.5 < ap ≤ 10		0.1 < ap ≤ 2.5		2.5 < ap ≤ 10				
(mm)															
min		max		min		max		min		max					
P	Unalloyed steel	<600	<180	1.00	10.00	0.20	0.70	0.15	0.38	0.20	0.80	0.15	0.40		
		<950	<280												
	Alloyed steel	700-950	200-280			0.18	0.65	0.12	0.35	0.18	0.70	0.12	0.38		
		950-1200	280-355												
	1200-1400	355-415													
M	Duplex stainless steel	778	230												
	Austenitic stainless steel	675	200			0.15	0.60	0.12	0.32	0.15	0.65	0.12	0.35		
	Precipitation-hardening stainless steel	1013	300												
K	Grey cast iron	700	220					-	-	-	-	-	-	-	
	Nodular cast iron	880	260												
	Malleable cast iron	800	250												
N	Aluminum	260	75					-	-	-	-	-	-	-	
	Aluminum alloy	447	130												
S	Fe-based alloy	943	280			0.15	0.55	0.12	0.32	-	-	-	-		
	Co-based alloy	1076	320												
	Ni-based alloy	1177	350												
	Ti-alloy	1262	370												
H	Hardened steel	-	50-60HRC			-	-	-	-	-	-	-			
	Chilled cast iron	-	55HRC												

*The recommended cutting conditions always refer to general conditions. These cutting conditions should be adjusted according to the practical machine rigidity, tools, workpiece clamping and coolant. Average chip thickness (hm)=fz x sinkr.









Milling cutters

Milling Insert Denomination System

A
1

O
2







1- Shape/Code

A	H	M	O	R
				
S	T	Z	X	Special
				

M
3

T
4

2- Clearance Angle

C	D	E	F
			
G	N	P	O
			Other clearance angle

3- Tolerance

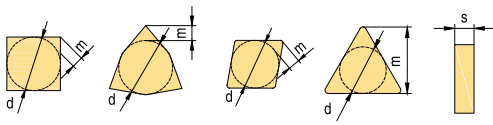















Class	Unit	In.Circle dimension d	Nose height m	Thickness s
A	mm	± 0,025	± 0,005	± 0,025
C	mm	± 0,025	± 0,013	± 0,025
E	mm	± 0,025	± 0,025	± 0,025
F	mm	± 0,013	± 0,005	± 0,025
G	mm	± 0,025	± 0,025	± 0,13
H	mm	± 0,013	± 0,013	± 0,025
J	mm	*	± 0,005	± 0,025
K	mm	*	± 0,013	± 0,025
L	mm	*	± 0,025	± 0,025
M	mm	*	*	± 0,127
U	mm	*	*	± 0,127
N	mm	*	*	± 0,025

* For details refer to right and below tables

IC	Shape: C, E, H, M, O, P, S, T, R, W			
	d		m	
	J,K,L,M,N	U	M, N	U
4.76	± 0,05	± 0,08	± 0,08	± 0,13
5.56	± 0,05	± 0,08	± 0,08	± 0,13
6	± 0,05	± 0,08	± 0,08	± 0,13
6.35	± 0,05	± 0,08	± 0,08	± 0,13
7.94	± 0,05	± 0,08	± 0,08	± 0,13
8	± 0,05	± 0,08	± 0,08	± 0,13
9.525	± 0,05	± 0,08	± 0,08	± 0,13
10	± 0,05	± 0,08	± 0,08	± 0,13
12	± 0,08	± 0,13	± 0,13	± 0,2
12.7	± 0,08	± 0,13	± 0,13	± 0,2
15.875	± 0,1	± 0,18	± 0,15	± 0,27
16	± 0,1	± 0,18	± 0,15	± 0,27
19.05	± 0,1	± 0,18	± 0,15	± 0,27
20	± 0,1	± 0,18	± 0,15	± 0,27
25	± 0,13	± 0,25	± 0,18	± 0,38
25.4	± 0,13	± 0,25	± 0,18	± 0,38
31.75	± 0,15	± 0,25	± 0,2	± 0,38
32	± 0,15	± 0,25	± 0,2	± 0,38

M&N shape	D shape		V shape	
	d	m	d	m
5.56	± 0,05	± 0,11		
6.35	± 0,05	± 0,11	± 0,05	± 0,16
7.94	± 0,05	± 0,11	± 0,05	± 0,16
9.525	± 0,05	± 0,11	± 0,05	± 0,16
12.7	± 0,08	± 0,15	± 0,08	± 0,2
15.875	± 0,10	± 0,18	± 0,10	± 0,27
19.05	± 0,10	± 0,18	± 0,10	± 0,27

4- Clamping Type

A	B	C	F	G
				
H	J	M	N	Q
				
R	T	U	W	Z
				Special

12	04	08					
5	6	7					
5- Cutting Edge Length							
In.Circle dimension (mm)	H	M	O	R	S	T Z	
3.180						05	
3.970						06	
5.000				05			
5.560						09	
6.000				06			
6.350						11	
7.940						13	
8.000				08			
9.525				09	09	16	
10.000				10			
12.000				12			
12.700			04	12	12	22	
15.875				15	15	27	
16.000			06	16			
19.050				19	19	33	
20.000				20			
25.000				25	25		
25.400				25			
31.750				31			
32.000				32			

7-Corner Radius and Wiper Edge	
	00 = sharp
	01 = 0.1
	02 = 0.2
	04 = 0.4
	08 = 0.8
	12 = 1.2
	16 = 1.6
	20 = 2.0
	24 = 2.4
	28 = 2.8
	32 = 3.2
	40 = 4.0
	48 = 4.8
	56 = 5.6
	64 = 6.4
	X = others
Round insert:MO refers to metric dia. size	
1 Approach angle(Entering angle) (kr)	2 Clearance angle of wiper edge (n)
A = 45°	A = 3°
D = 60°	B = 5°
E = 75°	C = 7°
F = 85°	D = 15°
P = 90°	E = 20°
Z = Others	F = 25°
	G = 30°
	N = 0°
	P = 11°
	Z = Others

E	R	-	MM4
8	9	-	10
6- Insert Thickness			
			01=1.59mm
			T1=1.98mm
			02=2.38mm
			T2=2.78mm
			03=3.18mm
			T3=3.97mm
			04=4.76mm
			05=5.56mm
			06=6.35mm
			07=7.94mm
			09=9.52mm

8- Edge Preparation		
Sharp cutting edge	Honed cutting edge	Negative land
Double negative land	Negative land +honed	Double negative land +honed

9-Hand of Tool		
Right hand	Left hand	Neutral

10-Geometry Refers to Geometry Introduction

Marked: if it has corner radius, the information needs to put between thickness and wipers.
Example: APET 160408PDFR-FM2

Milling cutters

ACHTTECK

www.achtecktool.com/en

THE EXPERT OF DIFFICULT MACHINING



Milling Inserts







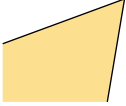

Geometry Application Guide

Materials				Milling geometry application table						
				FM2	MM3	MM4	MR2	MR6	RR2	HR2
ISO	Material classification	Tensile strength (N/mm ²)	Hardness (HB)	Suitable for machining aluminium alloy	Light cutting	General purpose	Medium machining	Roughing	Heavy roughing	Roughing
P	Unalloyed steel	<600	<180	-	●	●	●	●	-	-
		<950	<280	-	●	●	●	●	-	-
	Alloyed steel	700-950	200-280	-	●	●	●	●	-	-
		950-1200	280-355	-	●	●	●	●	-	-
		1200-1400	355-415	-	●	●	●	●	-	-
M	Duplex stainless steel	778	230	-	●	●	●	-	-	-
	Austenitic stainless steel	675	200	-	●	●	●	-	-	-
	Precipitation-hardening stainless steel	1013	300	-	●	●	●	-	-	-
K	Grey cast iron	700	220	-	-	●	●	●	●	●
	Nodular cast iron	880	260	-	-	●	●	●	●	●
	Malleable cast iron	800	250	-	-	●	●	●	●	●
N	Aluminum	260	75	●	-	-	-	-	-	-
	Aluminum alloy	447	130	●	-	-	-	-	-	-
S	Fe-based alloy	943	280	-	●	●	●	-	-	-
	Co-based alloy	1076	320	-	●	●	●	-	-	-
	Ni-based alloy	1177	350	-	●	●	●	-	-	-
	Ti-alloy	1262	370	-	●	●	●	-	-	-
H	Hardened steel	-	50-60HRC	-	-	●	●	-	-	-
	Chilled cast iron	-	55HRC	-	-	●	●	-	-	-

- 1st choice
- ◐ 2nd choice
- Inapplicable

Milling cutters

Milling Geometry Introduction

Insert geometry	Edge shape	Application
FM2		<ul style="list-style-type: none"> ▪ Low cutting force, for weak machining condition ▪ Sharp geometry ▪ For aluminium material machining
MM3		<ul style="list-style-type: none"> ▪ Low cutting force, for weak machining condition ▪ Sharp geometry ▪ For steel, stainless-steel and heat resistant alloy machining.
MM4		<ul style="list-style-type: none"> ▪ For medium machining condition ▪ Universal geometry ▪ For machining most materials
MR2		<ul style="list-style-type: none"> ▪ For medium or better machining condition ▪ Universal geometry ▪ For machining most materials
MR6		<ul style="list-style-type: none"> ▪ For stable machining condition ▪ Roughing geometry ▪ For machining most materials
HR2		<ul style="list-style-type: none"> ▪ For stable machining condition ▪ Roughing geometry ▪ Mainly for cast iron machining
RR2		<ul style="list-style-type: none"> ▪ For stable machining condition ▪ Heavy roughing geometry ▪ Mainly for cast iron and steel machining
IT		<ul style="list-style-type: none"> ▪ Sharp geometry, for specified product
DT		<ul style="list-style-type: none"> ▪ Universal geometry, for specified product

Grade Application Guide

Milling grade ISO group															
Material Group	Materials	ISO	coated											Uncoated	ISO
			PVD	PVD	PVD	PVD	PVD	PVD	PVD	PVD	PVD	CVD	CVD		
P	unalloy steels / Alloyed steels	P01													P01
		P05													P05
		P10													P10
		P15													P15
		P20	AP251U												P20
		P25										AC301P			P25
		P30		AP351U		AP351M									P30
		P35													P35
		P40			AP351U										P40
		P45													P45
M	Stainless steels	M01												M01	
		M05												M05	
		M10												M10	
		M15												M15	
		M20	AP251U											M20	
		M25												M25	
		M30				AP351M								M30	
		M35						AP403S	AP403M					M35	
		M40												M40	
		M45												M45	
K	Cast iron	K01												K01	
		K05												K05	
		K10												K10	
		K15												K15	
		K20	AP251K		AP151H							AC301K		K20	
		K25												K25	
		K30												K30	
		K35												K35	
		K40												K40	
		K45												K45	
N	Aluminum/ Aluminum alloys	N01												N01	
		N05												N05	
		N10											AW100K	N10	
		N15												N15	
		N20												N20	
		N25												N25	
		N30												N30	
S	Heat resistant alloys	S01												S01	
		S05												S05	
		S10												S10	
		S15												S15	
		S20												S20	
		S25												S25	
		S30			AP351M									S30	
		S35					AP403S							S35	
		S40					AP403M							S40	
		S45												S45	
H	Hardened steels/ Chilled cast iron	H01												H01	
		H05												H05	
		H10	AP151H											H10	
		H15												H15	
		H20												H20	
		H25												H25	
		H30												H30	

Milling cutters

Grade Application Guide

Materials				Milling grade application										
				PVD coated						CVD coated		PVD coated		Uncoated
ISO	Material classification	Tensile strength (N/mm ²)	Hardness (HB)	AP251U	AP351U	AP351M	AP401U	AP403S	AP403M	AC301P	AC301K	AP251K	AP151H	AW100K
P	Unalloyed steel	<600	<180	●	●	●	●		●	●	●	-	-	-
		<950	<280	●	●	●	●		●	●	●	-	-	-
	Alloyed steel	700-950	200-280	●	●	●	●		●	●	●	-	-	-
		950-1200	280-355	●	●	●	●		●	●	●	-	-	-
		1200-1400	355-415	●	●	●	●		●	●	●	-	-	-
M	Duplex stainless steel	778	230	○	●	●	●	●	●	○	-	-	-	-
	Austenitic stainless steel	675	200	○	●	●	●	●	●	○	-	-	-	-
	Precipitation-hardening stainless steel	1013	300	○	●	●	●	●	●	○	-	-	-	-
K	Grey cast iron	700	220	-	-	-	-	-	-	-	●	●	●	-
	Nodular cast iron	880	260	-	-	-	-	-	-	-	●	●	●	-
	Malleable cast iron	800	250	-	-	-	-	-	-	-	●	●	●	-
N	Aluminum	260	75	-	-	-	-	-	-	-	-	-	-	●
	Aluminum alloy	447	130	-	-	-	-	-	-	-	-	-	-	●
S	Fe-based alloy	943	280	-	○	●	○	●	●	-	-	-	-	-
	Co-based alloy	1076	320	-	○	●	○	●	●	-	-	-	-	-
	Ni-based alloy	1177	350	-	○	●	○	●	●	-	-	-	-	-
	Ti-alloy	1262	370	-	○	●	○	●	●	-	-	-	-	○
H	Hardened steel	-	50-60HRC	-	-	-	-	-	-	-	-	-	●	-
	Chilled cast iron	-	55HRC	-	-	-	-	-	-	-	-	-	●	-

- 1st choice
- 2nd choice
- Inapplicable

Milling Grade Description

Grade for Normal Milling

P

Steel, alloyed steel, unalloyed steel

Basic grade

AP251U P25(P15-P35)

PVD-coated grade, suitable for most applications. First choice for steel machining. It is recommended to be used in rough to finish machining of steel under stable working conditions, good for dry and wet machining with small cutting width, complex tool path and sticky materials.

AC301P P35(P25-P40)

CVD coated grade is suitable for big cutting depth, medium to high speed milling of steel under bad machining conditions.

Supplemental grade

AP351M P35(P25-P45)

PVD coated grade, medium hardness substrate, which is a supplement for AP251U in steel milling when high-toughness is requested.

AP351U P35(P30-P45)

PVD coated grade, medium hardness substrate, which is a supplement for AP251U in steel milling when high-toughness is requested.

M

Stainless steel, austenite stainless steel, martensite stainless steel

Basic grade

AP351M M35(M25-M45)

PVD coated grade is used for milling stainless steel and steel at medium and low speed under bad machining conditions.

AP403M M35(M35-M50)

Ultra-thick PVD coated grade is the first choice for stainless steel milling. It is suitable for rough milling of stainless steel under bad machining conditions.

Supplemental grade

AP251U M25(M15-M35)

PVD coated grade is used in rough and finish milling of stainless steel under very stable machining conditions.

AP403S M15(M35-M50)

PVD coated grade, the substrate has both toughness and red hardness characteristics, and is suitable for rough milling of stainless steel under bad machining conditions. Milling at low cutting speed can get longer tool life.

AP351U M35(M30-M45)

PVD coated grade, medium hardness substrate, which is a supplement for AP251U in steel milling when high-toughness is requested. On the way to phase out.

K

Cast iron, grey cast iron, nodular cast iron

Basic grade

AC301K K25(K10-K35)

CVD coated grade, suitable for semi-finish milling and rough milling of grey cast iron at medium and high cutting speed, Recommended for dry cutting conditions, can achieve longer tool life.

AP251K K25(K15-K40)

PVD coated grade is suitable for semi-finish and rough milling of grey cast iron and nodular cast iron at medium and low cutting speed, and has good tool life under dry and wet conditions.

Supplemental grade

AP151H K15(K10-K20)

PVD coated grade is suitable for finish milling of grey cast iron and nodular cast iron, which can get constant surface quality and longer tool life.

N Non-ferrous metals

Basic grade

AW100K N15 (N10-N20)

Uncoated grade, combined with sharp cutting edge, used in aluminum alloy milling.

S Heat resistant alloy

Basic grade

AP403S S15(S35-S50)

PVD coated grade, the substrate has both toughness and red hardness characteristics, and is the first choice for titanium alloy machining, as well as the machining of heat resistant alloy under weak rigidity. It is applicable to the milling at low cutting speed and can get longer tool life.

Supplemental grade

AP351M S35(S25-S45)

PVD coated grade is suitable for semi-finishing to light rough machining of heat resistant alloy and titanium alloys.

AP403M S35(S35-S50)

The super-thick PVD coated grade is suitable for low-speed milling of heat resistant alloy and titanium alloys when high toughness is requested, especially in case of large cutting width.

H Hard material, hardened steel

Basic grade

AP151H H15(H10-H20)

PVD coated grade, suitable for milling hardened steel, can be used in rough and finish milling, meeting the needs of most occasions.

OD..06

Positive octagonal milling inserts

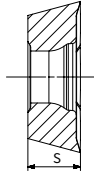
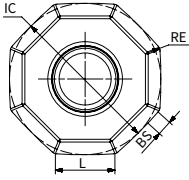

Inserts	Product code	Dimension (mm)					Machining conditions						
		L	IC	S	RE	BS	● Good condition ● General condition ✖ Bad condition						
							P			M	K		N
						AP251U	AP351U	AC301P	AP403M	AC301K	AP251K	AW100K	
	ODET 0605APFN-FM2	6	16	5.56	0.8	1.6							●
	ODMT 060508EN-MM3	6	16	5.56	0.8	-	●	▲	▲		▲	●	
	ODMT 060512EN-MM3	6	16	5.56	1.2	-	●						
	ODHT 0605APEN-MM3	6	16	5.56	0.8	1.6	●	▲			▲	●	
	ODEW 0605APSR-HR2	6	16	5.56	-	1.6					▲	●	
	ODMW 060512EN-HR2	6	16	5.56	1.2	-					▲	●	

●: Stock available ▲: Stock available now but will be replaced in the future.

Milling cutters

ON..05

Negative octagonal milling inserts

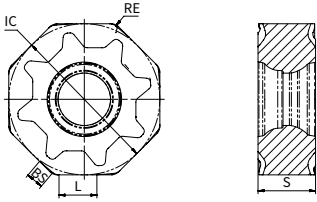

Inserts	Product code	Machining conditions					● Good condition ● General condition ✖ Bad condition						
		Dimension (mm)					P			M	K		N
		L	IC	S	RE	BS	AP25TU	AP35TU	AC301P	AP403M	AC301K	AP251K	AW100K
	ONHU 050408-MM3	4	12.7	4.76	0.8	-	●						
	ONMU 050408-MM4	4	12.7	4.76	0.8	-	●	▲			▲	●	
	ONHU 0504ZNR-MM3	4	12.7	4.76	0.8	1.4	●						

●: Stock available ▲: Stock available now but will be replaced in the future.

SD..09/12

Positive square milling inserts

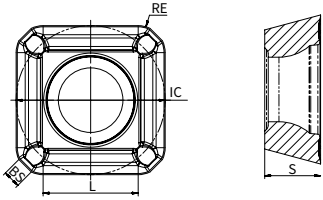

Inserts	Product code	Dimension (mm)					Machining conditions						
		L	IC	S	RE	BS	● Good condition				● General condition		
							● Bad condition	●	●	●	●	●	●
							P			M	K		N
							AP25TU	AP35TU	AC301P	AP403M	AC301K	AP251K	AW100K
	SDMT 09T304EN-MM3	8.7	9.525	3.97	0.4	-	●	▲	▲		▲		
	SDMT 09T308EN-MM3	7.9	9.525	3.97	0.8	-	●	▲			▲		
	SDMT 120408EN-MM4	11.1	12.7	4.76	0.8	-	●	▲		●	▲		
	SDMT 120412EN-MM3	10.3	12.7	4.76	1.2	-	●	●	▲		▲		
	SDKT 1204AEEN-MR2	8.1	12.7	4.76	-	2		▲				●	
	SDGT 09T3PDER-MR6	6.7	9.525	3.97	0.8	1.2	●	▲			●	●	

●: Stock available ▲: Stock available now but will be replaced in the future.

Milling cutters

SE..12

Positive square milling inserts

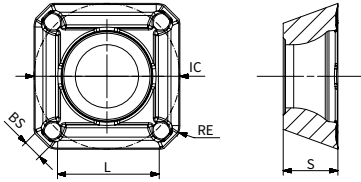

Inserts	Product code	Machining conditions					● Good condition ● General condition ✖ Bad condition						
		Dimension (mm)					P		M	K		N	
		L	IC	S	RE	BS	AP25TU	AP35TU	AC301P	AP403M	AC301K	AP251K	AW100K
	SEKT 1204AFER-MR2	8.9	12.7	4.91	1.2	1.8	●	▲					

●: Stock available ▲: Stock available now but will be replaced in the future.

SN..12/19

Negative short wiper milling inserts(applicable to AFM45-SN12/SN19 milling cutter)

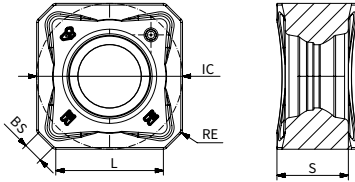

Inserts	Product code	Dimension (mm)					Machining conditions						
		L	IC	S	RE	BS	● Good condition ● General condition ✖ Bad condition						
							P			M	K		N
							AP251U	AP351U	AC301P	AP403M	AC301K	AP251K	AW100K
	SNHX 1206ANN-FM2	9.3	12.7	6.25	0.5	1.8							●
	SNGX 1206ANN-MM3	9.4	12.7	6.25	0.4	1.8	●	▲	▲		▲	●	
	SNGX 1206ANN-MM4	9.4	12.7	6.25	0.4	1.8	●	▲	▲	●	▲	●	
	SNGX 1206ANN-MR6	9.4	12.7	6.25	0.4	1.8	●	▲	▲		▲	●	
	SNGX 1206ANN-RR2	9.3	12.7	6.25	0.5	1.8	●	▲	▲		▲	●	
	SNMX 1206ANN-MM3	9.4	12.7	6.25	0.4	1.8	●	▲	▲		▲	●	
	SNMX 1206ANN-MM4	9.4	12.7	6.25	0.4	1.8	●	▲	▲	●	▲	●	
	SNMX 1206ANN-MR6	9.4	12.7	6.25	0.4	1.8	●	▲	▲		▲	●	
	SNGX 1909ANN-MM3	14.2	19.05	8.55	0.4	2.9		▲					
	SNGX 1909ANN-MR6	14.2	19.05	8.55	0.8	2.9		▲					

●: Stock available ▲: Stock available now but will be replaced in the future.

SNHX12

Negative long wiper milling inserts(applicable to AFM45-SN12 milling cutter)

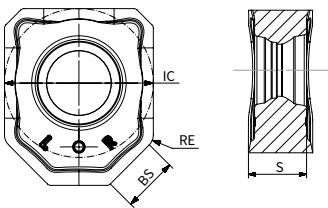

Inserts	Product code	Dimension (mm)					Machining conditions						
		L	IC	S	RE	BS	● Good condition ● General condition ✖ Bad condition						
							P			M	K		N
							AP251U	AP351U	AC301P	AP403M	AC301K	AP251K	AW100K
	SNHX 1206ANN-W	-	12.7	6.25	1.2	6.7	●				▲		

●: Stock available ▲: Stock available now but will be replaced in the future.

Milling cutters

SN..12

Negative short wiper milling inserts (applicable to AFM75-SN12 milling cutter)

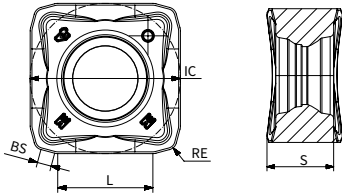

Inserts	Product code	Dimension (mm)					Machining conditions						
		L	IC	S	RE	BS	● Good condition ● General condition ✖ Bad condition						
							P	M	K		N		
AP251U	AP351U	AC301P	AP403M	AC301K	AP251K	AW100K							
	SNGX 1206ENN-MM3	8.1	12.7	6.35	0.8	1.2	●	▲	▲		▲	●	
	SNGX 1206ENN-MM4	8.1	12.7	6.35	0.8	1.2	●	▲	▲		▲	●	
	SNGX 1206ENN-MR6	8.1	12.7	6.35	0.8	1.2	●	▲	▲		▲	●	
	SNMX 1206ENN-MM4	8.1	12.7	6.35	0.8	1.2			▲			●	

●: Stock available ▲: Stock available now but will be replaced in the future.

SNHX12

Negative long wiper milling inserts (applicable to AFM75-SN12 milling cutter)

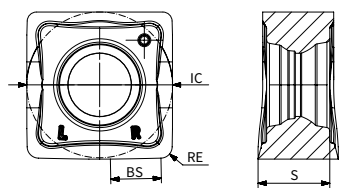

Inserts	Product code	Dimension (mm)					Machining conditions						
		L	IC	S	RE	BS	● Good condition ● General condition ✖ Bad condition						
							P	M	K		N		
AP251U	AP351U	AC301P	AP403M	AC301K	AP251K	AW100K							
	SNHX 1206ENN-W	-	12.7	6.25	0.6	1.2	●				▲		

●: Stock available ▲: Stock available now but will be replaced in the future.

SN..12

Negative short wiper milling inserts (applicable to AFM88-SN12 milling cutter)

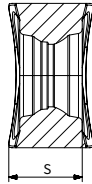
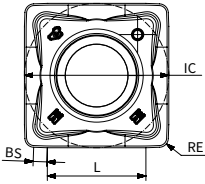

Inserts	Product code	Dimension (mm)					Machining conditions						
		L	IC	S	RE	BS	● Good condition ● General condition ✖ Bad condition						
							P			M	K		N
						AP251U	AP351U	AC301P	AP403M	AC301K	AP251K	AW100K	
	SNHX 1206ZNN-FM2	8.7	12.7	6.45	0.8	1.2							●
	SNGX 1206ZNN-MM4	8.7	12.7	6.45	0.8	1.2	●	▲	▲	●	▲	●	
	SNGX 1206ZNN-MR6	8.7	12.7	6.45	0.8	1.2	●	▲	▲		▲	●	
	SNGX 1206ZNN-MM3	8.7	12.7	6.45	0.8	1.2	●	▲	▲		▲	●	
	SNMX 1206ZNN-MM4	8.7	12.7	6.45	0.8	1.2	●			●		●	

●: Stock available ▲: Stock available now but will be replaced in the future.

SNHX12

Negative long wiper milling inserts (applicable to AFM88-SN12 milling cutter)

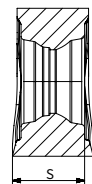
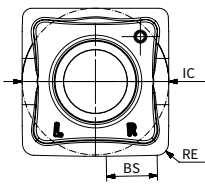

Inserts	Product code	Dimension (mm)					Machining conditions						
		L	IC	S	RE	BS	● Good condition ● General condition ✖ Bad condition						
							P			M	K		N
						AP251U	AP351U	AC301P	AP403M	AC301K	AP251K	AW100K	
	SNHX 1206ZNN-W	-	12.7	6.25	1.0	4.4	●				▲		

●: Stock available ▲: Stock available now but will be replaced in the future.

Milling cutters

SN..12

Negative square milling inserts with corner radius

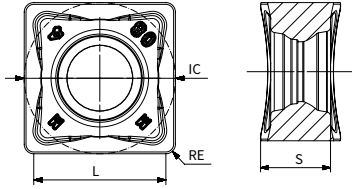

Inserts	Product code	Dimension (mm)					Machining conditions						
		L	IC	S	RE	BS	● Good condition ✖ Bad condition			⦿ General condition			
							P	M	K		N		
AP25TU	AP35TU	AC301P	AP403M	AC301K	AP251K	AW100K							
	SNGX 120608-MM4	11.1	12.7	6.4	0.8	-	●	▲	▲		▲	●	
	SNGX 120612-MM4	10.3	12.7	6.4	1.2	-	●						
	SNMX 120608-MM4	11.1	12.7	6.4	0.8	-	●	▲	▲		▲	●	
	SNMX 120612-MM3	10.3	12.7	6.4	1.2	-	●	▲	▲		▲	●	
	SNMX 120612-MM4	10.3	12.7	6.4	1.2	-	●	▲	▲		▲	●	
	SNMX 120612-MR6	10.3	12.7	6.4	1.2	-	●	▲	▲		▲	●	
	SNMX 120612-RR2	10.3	12.7	6.4	1.2	-	●	▲	▲		▲	●	
	SNMX 120620-MM4	8.7	12.7	6.4	2.0	-	●	▲	▲		▲	●	
	SNMX 120620-RR2	8.7	12.7	6.4	2.0	-	●	▲	▲		▲	●	
	SNMX 120612R-MM4	8.7	12.7	6.4	1.2	-	●	▲	▲	●	▲	●	

●: Stock available ▲: Stock available now but will be replaced in the future.

XN..07/09ANN

Negative heptagonal milling inserts with short wiper

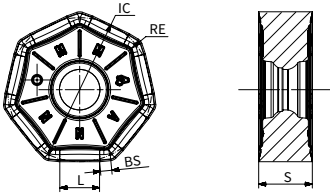

Inserts	Product code	Dimension (mm)					Machining conditions						
		L	IC	S	RE	BS	● Good condition			● General condition			
							● Good condition	● General condition	● Bad condition	● Good condition	● General condition	● Bad condition	● Good condition
						P			M	K		N	
						AP25TU	AP35TU	AC301P	AP403M	AC301K	AP251K	AW100K	
	XNGU 0705ANN-MM3	7	14.5	5	0.8	1.1	●	▲			▲		
	XNGU 0705ANN-MM4	7	14.5	5	0.8	1.1	●				▲		
	XNMU 0705ANN-MM4	7	14.5	5	0.8	1.1	●	▲	▲		▲	●	
	XNMU 0705ANN-MR6	7	14.5	5	0.8	1.1	●	▲			▲	●	
	XNGU 0906ANN-MM3	9.2	19	5.875	0.8	1.4	●	▲	▲		▲		
	XNGU 0906ANN-MM4	9.2	19	5.875	0.8	1.4	●	▲	▲		▲		
	XNMU 0906ANN-MR6	9.2	19	5.875	0.8	1.4	●				▲	●	

●: Stock available ▲: Stock available now but will be replaced in the future.

Milling cutters

XN..07/09

Negative heptagonal milling inserts with corner radius

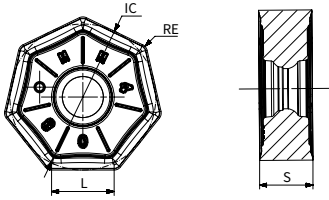

Inserts	Product code	Dimension (mm)					Machining conditions							
		L	IC	S	RE	BS	● Good condition ✖ Bad condition			⚙ General condition				
							●	⚙	⚙	✖	●	●	●	
							P				M	K		N
							AP251U	AP351U	AC301P	AP403M	AC301K	AP251K	AW100K	
	XNMU 070508-MM4	7	14.5	5	0.8	-	●	▲		●	▲	●		
	XNMU 090612-MM4	9.2	19	5.875	1.2	-	●	▲		●	▲	●		

●: Stock available ▲: Stock available now but will be replaced in the future.

XNGX 07/09ANN-W

Negative milling inserts with long wiper

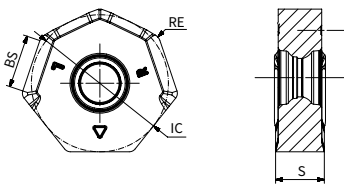

Inserts	Product code	Dimension (mm)					Machining conditions						
		L	IC	S	RE	BS	● Good condition ✖ Bad condition			⚙ General condition			
							●	⚙	⚙	✖	●	●	●
							P				M	K	N
							AP251U	AP351U	AC301P	AP403M	AC301K	AP251K	AW100K
	XNGX 0705ANN-W	6	15	5	1.0	1.1	●				▲		
	XNGX 0906ANN-W	7.5	19.05	5.88	1.0	1.4	●				▲		

●: Stock available ▲: Stock available now but will be replaced in the future.

LNET 12

Square shoulder milling inserts

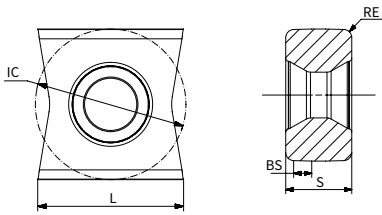

Inserts	Product code	Machining conditions					● Good condition ● General condition ✖ Bad condition						
		Dimension (mm)					P		M	K		N	
		L	IC	S	RE	BS	AP251U	AP351U	AC301P	AP403M	AC151K	AP251K	AW100K
	LNET 1206-MM4	12.3	12.7	6.35	0.8	2.5	●			●	●	●	

●: Stock available ▲: Stock available now but will be replaced in the future.

ON05/LN12/LN15

Cast iron finishing machining inserts

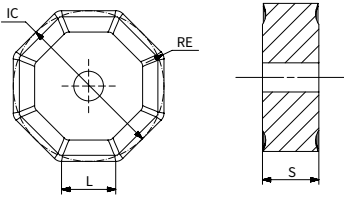

Inserts	Product code	Dimension (mm)				Machining conditions					
		L	IC	S	RE	● Good condition		⬢ General condition		✖ Bad condition	
						●	⬢	✖	●	●	●
						P	M	K	H		
						AP251U	AP351U	AP403M	AC301K	AP251K	AP151H
	ONHF 050408-MM3	5.3	12.7	4.76	0.8						●

●: Stock available ▲: Stock available now but will be replaced in the future.

LN12

Cast iron finishing wiper insert

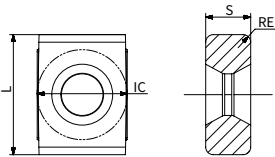

Inserts	Product code	Dimension (mm)				Machining conditions					
		L	IC	S	RE	● Good condition		⬢ General condition		✖ Bad condition	
						●	⬢	✖	●	●	●
						P	M	K	H		
						AP251U	AP351U	AP403M	AC301K	AP251K	AP151H
	LNHQ 120408FN-W	12.7	9.525	4.76	0.8						●

●: Stock available ▲: Stock available now but will be replaced in the future.

LN15

Cast iron finishing wiper insert

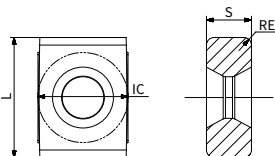

Inserts	Product code	Dimension (mm)				Machining conditions					
		L	IC	S	RE	● Good condition		⬢ General condition		✖ Bad condition	
						●	⬢	✖	●	●	●
						P	M	K	H		
						AP251U	AP351U	AP403M	AC301K	AP251K	AP151H
	LNHQ 150416FN-W	15.875	9.525	4.76	1.6						●

●: Stock available ▲: Stock available now but will be replaced in the future.

LNHU 0904..

Negative square shoulder milling inserts

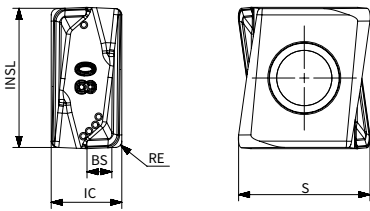

Inserts	Product code	Dimension (mm)					Machining conditions						
		INSL	IC	S	RE	BS	● Good condition ✖ Bad condition				⊕ General condition		
							●	⊕	⊕	✖	●	●	●
						P			M	K		N	
						AP251U	AP351U	AP351M	AP403M	AC301K	AP251K	AW100K	
	LNHU 090404ER-FM2	9	4.5	8.49	0.4	1.85							●
	LNHU 090404ER-MM3	9	4.5	8.49	0.4	1.85		▲		●			
	LNHU 090404ER-MR2	9	4.5	8.49	0.4	1.85	●	▲		●	▲	●	
	LNHU 090404ER-MM4	9	4.5	8.5	0.4	1.85	●		●	●		●	
	LNHU 090408ER-MM4	9	4.5	8.5	0.8	1.45	●		●	●		●	
	LNHU 090408ER-MR2	9	4.5	8.4	0.8	0.98	●	▲		●	▲	●	
	LNHU 090408ER-MM3	9	4.5	8.5	0.8	1.45	●		●	●		●	
	LNHU 090412ER-MR2	9	4.5	8.31	1.2	1.0	●			●	▲		
	LNHU 090416ER-MR2	9	4.5	8.22	1.6	0.65	●			●	▲		
	LNHU 090420ER-MR2	9	4.5	8.12	2.00	0.65	●			●	▲		

●: Stock available ▲: Stock available now but will be replaced in the future.

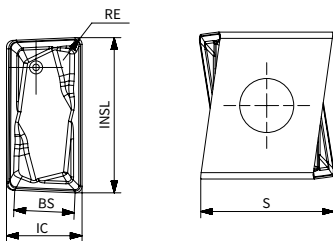

Inserts	Product code	Dimension (mm)					Machining conditions						
		INSL	IC	S	RE	BS	● Good condition ✖ Bad condition				⊕ General condition		
							●	⊕	⊕	✖	●	⊕	●
						P			M	K		N	
						AP251U	AP351U	AP351M	AP403M	AC301K	AP251K	AP351K	AW100K
	LNHU 0904PDER-W	9.2	4.5	8.38	0.4	3.6	●				▲		

●: Stock available ▲: Stock available now but will be replaced in the future.

Milling cutters

LNHU 1306..

Negative square shoulder milling inserts

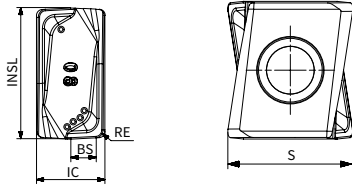

Inserts	Product code	Dimension (mm)					Machining conditions							
							● Good condition ● General condition ✖ Bad condition							
		INSL	IC	S	RE	BS	P			M	K		N	
						AP251U	AP351U	AP351M	AP403M	AC301K	AP251K	AP351K	AW100K	
	LNHU 130608ER-FM2	13.02	6.8	8.49	0.8	2.7								●
	LNHU 130608ER-MM3	13.02	6.8	11.85	0.8	2.7		▲		●				
	LNHU 130608ER-MM4	13.02	6.8	11.85	0.8	2.7	●		●	●		●		
	LNHU 130608ER-MR2	13.02	6.8	11.85	0.8	2.7	●	▲	●	●	▲	●		
	LNHU 130612ER-MM4	13.02	6.8	11.74	1.2	2.3	●		●	●		●		
	LNHU 130612ER-MR2	13.02	6.8	11.73	1.2	1.3	●	▲	●	●	▲	●		
	LNHU 130616ER-MR2	13.02	6.8	11.6	1.6	1.9	●	▲	●	●		●		
	LNHU 130620ER-MR2	13.02	6.8	11.52	2	1.5		▲	●	●	▲			
	LNHU 130624ER-MR2	13.02	6.8	11.4	2.4	1.0		▲	●	●	▲			
	LNHU 130631ER-MR2	13.02	6.8	11.23	3.1	0.4		▲	●	●	▲			

●: Stock available ▲: Stock available now but will be replaced in the future.

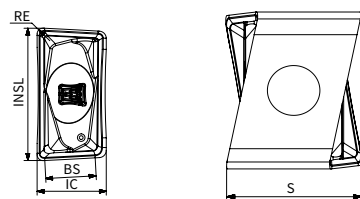



Inserts	Product code	Dimension (mm)					Machining conditions							
							● Good condition ● General condition ✖ Bad condition							
		INSL	IC	S	RE	BS	P			M	K		N	
						AP251U	AP351U	AP351M	AP403M	AC301K	AP251K	AP351K	AW100K	
	LNHU 1306PDR-W	13.39	6.8	11.63	0.8	5.2	●						●	

●: Stock available ▲: Stock available now but will be replaced in the future.

LNHU 1607..

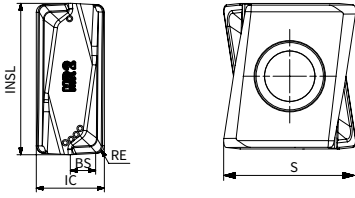
Negative square shoulder milling inserts



Inserts	Product code	Dimension (mm)					Machining conditions							
		INSL	IC	S	RE	BS	● Good condition ● General condition ✖ Bad condition							
							P			M	K		N	
							AP251U	AP351U	AP351M	AP403M	AC301K	AP251K	AW100K	
	LNHU 160708ER-MR2	16	7.2	15.1	0.8	1.97	●	▲				▲	●	
	LNHU 160716ER-MR2	16	7.2	14.94	1.6	1.5	●					▲		

●: Stock available ▲: Stock available now but will be replaced in the future.

Milling cutters

TDMT 1505..

Positive square shoulder triangle milling inserts

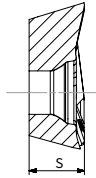
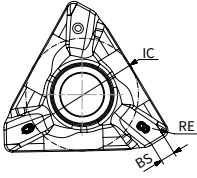

Inserts	Product code	Machining conditions										
		Dimension (mm)				● Good condition ● General condition ✖ Bad condition						
		IC	S	RE	BS	P			M	K		N
				AP25TU	AP35TU	AP35TM	AP403M	AC301K	AP251K	AW100K		
	TDMT 150508R-MM4	11.4	5.6	0.8	1.49	●		●	●	▲	●	
	TDMT 150512R-MM4	11.4	5.6	1.2	1.0	●		●	●	▲	●	
	TDMT 150516R-MM4	11.4	5.6	1.6	0.93	●		●	●	▲	●	
	TDMT 150520R-MM4	11.4	5.6	2.0	0.71	●			●		●	
	TDMT 150524R-MM4	11.4	5.6	2.4	0.59	●			●		●	
	TDMT 150531R-MM4	11.4	5.56	3.1	0.4	●			●		●	
	TDMT 150540R-MM4	11.4	5.56	4.0	0.4	●			●		●	
	TDMT 150508R-MM3	11.4	5.56	0.8	1.49	●			●		●	
	TDHT 150508R-MM4	11.4	5.6	0.8	1.5	●					●	

●: Stock available ▲: Stock available now but will be replaced in the future.

WNGU 0806..

Negative square shoulder milling inserts

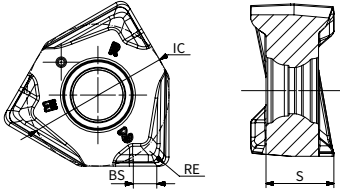

Inserts	Product code	Dimension (mm)				Machining conditions								
		IC	S	RE	BS	● Good condition ⚙ General condition ✖ Bad condition								
						P	M	K	N	H				
						AP251U	AP351U	AP351M	AP401U	AP403M	AC301K	AP251K	AW100K	AP151H
	WNHU 080608R-FM2	12.5	6.45	0.8	2.0								●	
	WNGU 080604R-MM3	12.5	6.44	0.4	2.2		▲	●	▲					
	WNGU 080608R-MM3	12.5	6.45	0.8	2.0	●	▲	●	▲	●		●		
	WNGU 080604R-MM4	12.5	6.44	0.4	2.2	●	▲	●	▲			●		
	WNGU 080608R-MM4	12.5	6.44	0.8	2.0	●	▲	●	▲		▲	●		●
	WNGU 080612R-MM4	12.5	6.44	1.2	1.6	●	▲	●	▲					
	WNGU 080616R-MM4	12.5	6.44	1.6	1.2	●	▲	●	▲					
	WNGU 080608R-MR2	12.5	6.45	0.8	2.0	●	▲	●		●	▲	●		
	WNGU 080612R-MR2	12.5	6.44	1.2	1.6	●		●				●		
	WNGU 080616R-MR2	12.5	6.45	1.6	1.2	●		●				●		

●: Stock available ▲: Stock available now but will be replaced in the future.

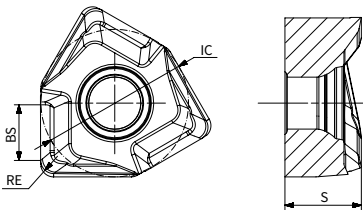

Inserts	Product code	Dimension (mm)				Machining conditions						
		IC	S	RE	BS	● Good condition ⚙ General condition ✖ Bad condition						
						P	M	K	N			
						AP301U	AP251U	AP351U	AP351M	AP403M	AC301K	AW100K
	WNHX 0806ZZR-W	12.5	6.47	1.1	4.71	●					▲	

●: Stock available ▲: Stock available now but will be replaced in the future.

Milling cutters

WNMU 0806..

Negative square shoulder milling inserts

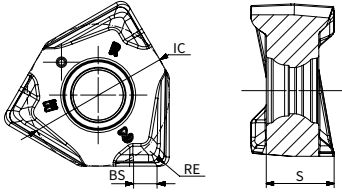

Inserts	Product code	Dimension (mm)				Machining conditions				
		IC	S	RE	BS	● Good condition		⚡ General condition		
						⚡ Bad condition				
					P		M	K		
					AP25TU	AP351M	AP403M	AC301K	AP251K	
	WNMU 080608R-MR2	12.5	6.6	0.8	2.3	●	●	●	▲	●
	WNMU 080608R-MM4	12.5	6.58	0.8	2.3	●	●	●	▲	●
	WNMU 080608R-MM3	12.5	6.58	0.8	2.3	●	●	●	▲	●
	WNMU 080612R-MR2	12.5	6.47	1.2	1.19	●	●		▲	●
	WNMU 080612R-MM4	12.5	6.47	1.2	1.18	●	●	●		●
	WNMU 080616R-MR2	12.5	6.5	1.6	0.81	●		●		
	WNMU 080616R-MM4	12.5	6.5	1.6	0.8	●		●		

●: Stock available ▲: Stock available now but will be replaced in the future.

APKT 1705..-DT..

Positive square shoulder milling inserts

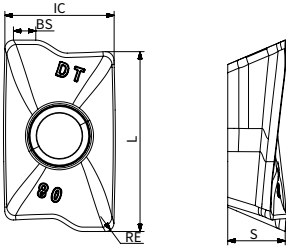

Inserts	Product code	Dimension (mm)					Machining conditions							
		L	IC	S	RE	BS	● Good condition ⬤ General condition ✖ Bad condition							
							P		M	K		N	S	
		AP251U	AP351U	AP351M	AP403M	AC301K	AP251K	AW100K	AP403S					
	APKT 1705PER-DT	17.4	10.76	5.63	0.8	2.16	●	▲		●		●	●	
	APKT 170516R-DT	17.4	10.74	5.63	1.6	1.72	●					●		
	APKT 170524R-DT	17.4	10.76	5.63	2.4	0.95	●		●	●		●		
	APKT 170530R-DT	17.4	10.76	5.63	3.0	1.48	●		●	●		●		
	APKT 170540R-DT	17.4	10.76	5.63	4.0	-	●		●	●				

●: Stock available ▲: Stock available now but will be replaced in the future.

Milling cutters

APKT 1003.IT

Positive square shoulder milling inserts

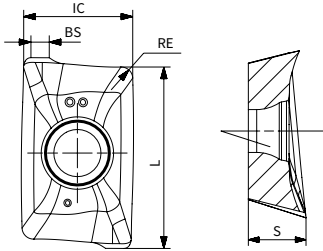

Inserts	Product code	Dimension (mm)					Machining conditions												
		L	IC	S	RE	BS	● Good condition				⚙ General condition								
							●	⚙	⚙	⚙	●	●	●	⚙					
							P				M				K			N	S
							AP251U	AP351U	AP351M	AP403M	AC301K	AP251K	AW100K	AP403S					
	APKT 1003PDER-IT	10.79	6.66	3.77	0.8	1.06	●	▲		●			●						

●: Stock available ▲: Stock available now but will be replaced in the future.

AOMT 1204..-MM4..

Positive square shoulder milling inserts

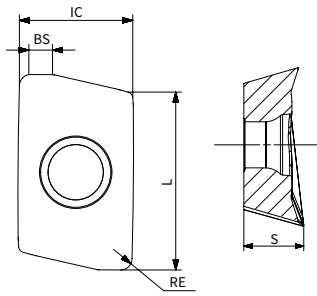

Inserts	Product code	Dimension (mm)					Machining conditions					
		L	IC	S	RE	BS	● Good condition		⬤ General condition		⬤ Bad condition	
							●	⬤	⬤	⬤	●	⬤
						P		M	K	S		
						AP251U	AP351U	AP351M	AP403M	AP251K	AP403S	
	AOMT 120408ER-MM4	12.8	8.15	5.07	0.8	1.56	●		●	●	●	●
	AOMT 120412ER-MM4	12.8	8.15	5.07	1.2	1.18			●	●		●
	AOMT 120416ER-MM4	12.8	8.15	5.07	1.6	1.2			●	●		●
	AOMT 120420ER-MM4	12.8	8.15	5.07	2.0	1.0	●		●	●		●
	AOMT 120424ER-MM4	12.8	8.15	5.07	2.4	0.9	●		●	●		●
	AOMT 120431ER-MM4	12.8	8.15	5.07	3.1	0.6			●	●		●
	AOMT 120440ER-MM4	12.8	8.15	5.07	4.0	0.8			●	●		●

●: Stock available ▲: Stock available now but will be replaced in the future.

Milling cutters

ADMT 11T3..-MM4..

Positive square shoulder milling inserts

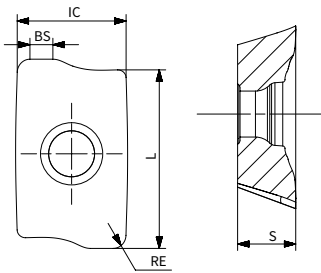



Inserts	Product code	Dimension (mm)					Machining conditions					
		L	IC	S	RE	BS	● Good condition ⚙ General condition ✖ Bad condition					
							P		M	K	S	
							AP251U	AP351U	AP351M	AP403M	AP251K	AP403S
	ADMT 11T304R-MM4	11	6.92	3.59	0.4	1.1	●		●	●	●	●
	ADMT 11T308R-MM4	11	6.92	3.59	0.8	1.41	●	▲	●	●	●	●
	ADMT 11T308R-MM3	11	6.92	3.59	0.8	1.3	●		●	●	●	
	ADMT 11T312R-MM4	11	6.92	3.59	1.2	0.8	●		●	●	●	●
	ADMT 11T316R-MM4	11	6.92	3.59	1.6	0.4	●		●	●	●	
	ADMT 11T320R-MM4	11	6.92	3.59	2.0	0.23	●	▲	●	●	●	●
	ADMT 11T324R-MM4	11	6.92	3.59	2.4	0.21	●		●	●	●	●
	ADMT 11T331R-MM4	11	6.92	3.59	3.1	0.63	●		●	●	●	

●: Stock available ▲: Stock available now but will be replaced in the future.

APMT..

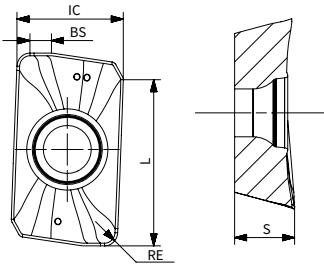
Positive square shoulder milling inserts



Inserts	Product code	Dimension (mm)					Machining conditions						
		L	IC	S	RE	BS	● Good condition			⚙ General condition			
							●	⚙	⚙	⚙	⚙	⚙	⚙
							P			M	K		H
							AP251U	AP351U	AP351M	AP403M	AC301K	AP251K	AP151H
	APMT 1135PDER	9.7	6.27	3.5	0.8	1.25	●	▲	●			●	●
	APMT 113508PDER	9.7	6.17	3.5	0.8	0.85	●	▲				●	
	APMT 1604PDER	12.7	9.37	5.17	0.8	1.54	●		●			●	●

●: Stock available ▲: Stock available now but will be replaced in the future.

Milling cutters

XD.09/12

High feed milling inserts

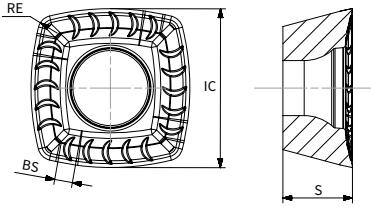

Inserts	Product code	Dimension (mm)				Machining conditions					
		IC	S	RE	BS	● Good condition			⚙ General condition		
						● Good condition	⚙ General condition	⚠ Bad condition	● Good condition	⚙ General condition	⚠ Bad condition
						P			K		S
						AP25TU	AP35TU	AC301P	AC301K	AP251K	AP403S
	XDLT 090408ER-MM3	9.525	4.76	0.8	1.3	●	▲	▲	▲		●
	XDLT 120508ER-MM3	12.7	5.56	0.8	2.2	●	▲	▲	▲	●	●
	XDLT 120512ER-MM3	12.7	5.56	1.2	2.2	●	▲	▲	▲	●	
	XDMW 090408ER-HR2	9.525	4.76	0.8	1.3				▲		
	XDMW 120508ER-HR2	12.7	5.56	0.8	2.2	●			▲		

●: Stock available ▲: Stock available now but will be replaced in the future.

RPM ...MM4
Profile milling inserts

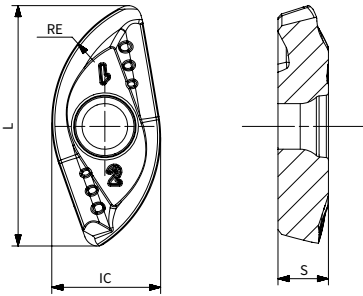

Inserts	Product code	Dimension (mm)				Machining conditions					
						● Good condition		● General condition		✘ Bad condition	
		L	IC	S	RE	●	●	✘	●	●	✘
				P	M	K					
				AP25TU	AP35TM	AP403M	AC301K	AP251K	AP403S		
	RPM 080ER-MM4	14.76	6.89	3.21	8.0	●	●	●			●
	RPM 100ER-MM4	18.85	8.62	3.89	10	●	●				●

●: Stock available ▲: Stock available now but will be replaced in the future.

RD/RP
Round inserts

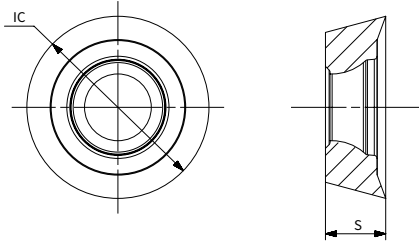

Inserts	Product code	Dimension (mm)		Machining conditions						
		IC	S	● Good condition ● General condition ✖ Bad condition						
				P			M	K		H
				AP25TU	AP35TU	AC301P	AP403M	AC301K	AP251K	AP151H
	RDHT 0702MOE-MM3	7	2.38	●						
	RDHT 1003MOE-MM3	10	3.18	●						
	RDHT 12T3MOE-MM3	12	3.97	●	▲	▲		▲	●	
	RDHT 1606MOE-MM3	16	6.35	●	▲	▲		▲	●	
	RDHT 1604MOE-MM3	16	4.76	●	▲				●	
	RDHW 0702MOS-HR2	7	2.38	●	▲	▲		▲	●	
	RDHW 1003MOS-HR2	10	3.18	●	▲	▲		▲	●	
	RDHW 12T3MOS-HR2	12	3.97	●	▲	▲		▲	●	
	RDHW 1606MOS-HR2	16	6.35	●					●	
	RDMT 0702MOE-MM3	7	2.38					▲		
	RDMT 1003MOE-MM3	10	3.18	●	▲	▲		▲		
	RDMT 12T3MOE-MM3	12	3.97	●		▲		▲		
	RDMT 1606MOE-MM3	16	6.35	●		▲		▲		
	RDMT 1604MOE-MM3	16	4.76			▲		▲		
	RDMW 1204MOE-HR2	12	4.76	●	▲					
	RDMW 1606MOE-HR2	16	6.35					▲		
	RPMW 1003MOE-HR2	10	3.18	●	▲					●
	RPMW 10T3MOE-HR2	10	3.97	●	▲					●
	RPMT 1204MOE	12	4.76	●	▲					●

●: Stock available ▲: Stock available now but will be replaced in the future.

RO.T
Profile milling inserts

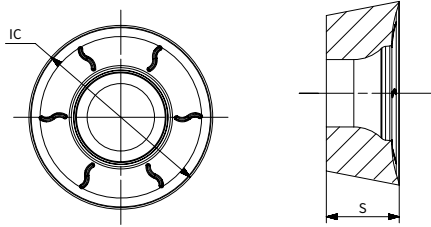

Inserts	Product code	Dimension (mm)		Machining conditions						
				● Good condition ⚠ Bad condition			⚠ General condition			
		IC	S	P			M	K		S
				AP251U	AP351U	AC301P	AP403M	AC301K	AP251K	AP403S
	ROHT 0803MOE-MM3	8	3.18				●			●
	ROHT 10T3M8E-MM3	10	3.97				●			●
	ROHT 1204M4E-MM3	12	4.76				●			●
	ROHT 1204M6E-MM3	12	4.76				●			●
	ROHT 1605M8E-MM3	16	5.56				●			●
	ROHT 2006M8E-MM3	20	6.35				●			●
	ROMT 10T3M4E-MR6	10	3.97				●			●
	ROMT 1204M6E-MR6	12	4.76				●			●
	ROMT 1605M6E-MR6	16	5.56				●			●
	ROMT 2006M8E-MR6	20	6.35				●			●

●: Stock available ▲: Stock available now but will be replaced in the future.

Milling cutters

Cutting Parameter Recommendation Table

Materials																	
ISO	Material classification	Brinell hardness (HB)	Tensile strength Rm(N/mm ²)	AP251U			AC301P			AP351U			AP351M				
				PVD	CVD	PVD	PVD	P15-P35	P25-40	P30-P45	P20-P40	M15-M35	—	M25-M35	M20-M40		
				—	—	S25-S35	—	—	—	—	—	—	—	—			
				—	—	—	—	—	—	—	—	—	—	—			
				—	—	—	—	—	—	—	—	—	—	—			
				1/10	1/5	1/1	1/10	1/5	1/1	1/10	1/5	1/1	1/10	1/5	1/1		
P	Unalloyed steel	C ≤ 0.25%	Annealed	125	428	320	280	240	380	300	260	280	240	200			
		0.25 < C ≤ 0.55%	Annealed	190	639	290	240	200	350	250	220	250	210	170			
		0.25 < C ≤ 0.55%	Heat-treated	210	708	260	210	170	310	220	190	230	180	140			
		C > 0.55%	Annealed	190	639	290	240	200	350	250	220	250	210	170			
		C > 0.55%	Heat-treated	300	1013	210	170	130	250	170	150	160	130	100			
	Low-alloyed steel	Free cutting steel (short-chip)	Annealed	220	745	250	200	160	300	210	180	220	170	130			
		Annealed	175	591	290	250	200	340	300	250	270	230	180				
		Heat-treated	285	960	250	210	160	290	250	200	230	190	140				
		Heat-treated	380	1282	230	190	140	250	210	160	210	170	120				
	High-alloyed steel and high-alloyed tool steel	Heat-treated	430	1477	190	150	110	210	170	130	170	130	90				
Annealed		200	675	220	190	160	240	210	180	200	170	140					
Hardened and tempered		300	1013	170	140	110	190	160	130	150	130	90					
Stainless steel	Hardened and tempered	400	1361	150	120	90	160	130	100	130	100	70					
	Ferritic/martensitic, annealed	200	675	190	160	130	200	170	140	160	140	110	180	150	120		
	Martensitic, heat-treated	330	1114	160	120	90	170	140	110	140	110	80	150	120	90		
M	Stainless steel	Austenitic, quench hardened	200	675	180	150	120				170	140	110	170	150	120	
		Austenitic, precipitation hardened (PH)	300	1013	160	130	100				150	120	90	150	130	100	
		Austenitic/ferritic, duplex	230	778	170	140	110				160	130	100	160	140	110	
K	Malleable cast iron	Ferritic	200	400													
		Pearlitic	260	700													
	Grey cast iron	Low tensile strength	180	200													
		High tensile strength/austenitic	245	350													
	Nodular cast iron	Ferritic	155	400													
Pearlitic		265	700														
GGV(CGI)		230	400														
N	Wrought aluminium alloys	Non-aging	30	-													
		Aged	100	340													
	Cast aluminium alloys	≤ 12% Si, non-aging	75	260													
		≤ 12% Si, aged	90	310													
		> 12% Si, non-aging	130	450													
	Magnesium alloys	Unalloyed, electrolytic copper	100	340													
		Brass, bronze, red brass	90	310													
Cu alloys, short-chipping		110	380														
High-tensile, Ampco alloy		300	1010														
S	Heat-resistant alloys	Fe-based	Annealed	200	680						90	80	70	100	90	80	
			Hardened	280	940							75	60	50	80	70	60
		Ni or Co based	Annealed	250	840							80	55	45	70	60	50
			Hardened	350	1180							60	50	35	60	50	40
	Titanium alloys	Cast	320	1080							60	55	40	65	55	45	
		Pure titanium	200	680							110	90	80	120	100	90	
α and β alloys, hardened		375	1260							50	40	30	55	45	35		
Tungsten alloys	β alloys	410	1400							50	40	30	55	45	35		
Molybdenum alloys		300	1010							65	60	50	70	65	55		
H	Hardened steel	Hardened and tempered	50HRC														
		Hardened and tempered	55HRC														
		Hardened and tempered	60HRC														
	Chilled cast iron	Hardened and tempered	50HRC														

*The recommended cutting conditions always refer to general conditions. These cutting conditions should be adjusted according to the practical machine rigidity, tools, workpiece clamping and coolant. Average chip thickness (hm)=fz x sinkr.

ACHTTECK





























www.achtecktool.com/en

THE EXPERT OF DIFFICULT MACHINING



Solid End Mills

Solid carbide end mills

Series	Pictures	Catagory	Teeth	Helix angles	Application	Cutting edge tolerance (mm)	Diameter (mm)	Material	Information
M100-2ES		ECO line	Z=2	35°		+0.00 -0.03	1-20	Universal type	Used in carbon steel, tool steel, alloyed steel machining. The workpiece hardness is up to HRC45°
M100-4ES		ECO line	Z=4	35°		+0.00 -0.03	1-20	Universal type	Used in carbon steel, tool steel, alloyed steel machining. With 4 cutting edges, it can achieve better surface finish. The workpiece hardness is up to HRC45°
M100-4EL		ECO line	Z=4	35°		+0.00 -0.03	3-20	Universal type	Used in carbon steel, tool steel, alloyed steel machining. With 4 long edge design. The workpiece hardness is up to HRC45°
M100-4RL		ECO line	Z=4	30°		R±0.02	4-12	Universal type	Used in carbon steel, tool steel, alloyed steel machining. The round corner can prevent edge breakage during high-speed cutting. With 4 long edge design. The workpiece hardness is up to HRC45°
M100-2BS		ECO line	Z=2	30°		≤6±0.01 >6±0.02	2-20	Universal type	Used in carbon steel, tool steel, alloyed steel machining. For profile milling, good toughness. The workpiece hardness is up to HRC45°
M105-6ES		ECO line	Z=6	45°		+0.00 -0.03	4-20	Universal type	High speed cutting and high feed finish cutting. Ideal choice for side finish milling. The workpiece hardness is up to HRC45°
M105-6EL		ECO line	Z=6	45°		+0.00 -0.03	6-20	Universal type	High speed cutting and high feed finish cutting. With 6 long edge design. Ideal choice for side finish milling. The workpiece hardness is up to HRC45°
M145-2ES		ECO line	Z=2	45°		+0.00 -0.02	3-20	Aluminium alloy	Design for vibration resistance. With special edge treatment. It can achieve better surface finish.
M145-3ES		ECO line	Z=3	45°		+0.00 -0.02	3-20	Aluminium alloy	Design for vibration resistance. With special edge treatment. It can achieve better surface finish.
M145-3EL		ECO line	Z=3	45°		+0.00 -0.02	4-20	Aluminium alloy	Design for vibration resistance. With special edge treatment. It can achieve better surface finish.
M110-2ES		Pro line	Z=2	35°		+0.00 -0.02	3-20	Universal type	Use in carbon steel, tool steel, alloyed steel machining. The workpiece hardness is up to HRC55°
M110-4ES		Pro line	Z=4	35°		+0.00 -0.02	3-20	Universal type	4 cutting edges can achieve better surface finishing. The workpiece hardness is up to HRC55°
M110-2BS		Pro line	Z=2	30°		≤6 ±0.01 >6 ±0.02	3-20	Universal type	Use in profile machining. The workpiece hardness is up to HRC55° and high feed.
M115-6ES		Pro line	Z=6	45°		+0.00 -0.02	6-18	Universal type	For high speed finish and high feed milling. Excellent surface finishing. 1st choice for side finish milling. The workpiece hardness is up to HRC55°
M116-4PS		Pro line	Z=4-6	45°		h10	6-20	P, M, K, S	For rough milling steel, stainless steel, Ni-based alloyed, titanium alloyed, inconel, etc. Thanks to the fine waved cutting edge, the tool has low cutting force and high chip removal rate.
M121-4CSP		XP Line	Z=4	35°/38°		≤12+0.00/-0.02 >12+0.00/-0.03	4-20	P, M, K, S	Used in stainless steel, soft steel and cast iron milling. Special flute geometry and differential helix eliminate vibration. With extended edge design. The workpiece hardness is up to HRC40°
M121-4CS		XP Line	Z=4	35°/38°		≤12+0.00/-0.02 >12+0.00/-0.03	4-20	P, M, K, S	Used in stainless steel, soft steel and cast iron milling. Special flute geometry and differential helix eliminate vibration. The workpiece hardness is up to HRC40°
M121-4ESP		XP Line	Z=4	35°/38°		≤12+0.00/-0.02 >12+0.00/-0.03	4-20	P, M, K, S	Used in stainless steel, soft steel and cast iron milling. Special flute geometry and differential helix eliminate vibration. With extended edge design. The workpiece hardness is up to HRC40°
M125-6ES		XP Line	Z=6	45°		≤12+0.00/-0.02 >12+0.00/-0.03	6-20	P, M, K, S	Used in stainless steel, soft steel and cast iron milling. It has close pitch to provide a better surface finish and tool life under the condition of high speed milling and cycloid milling.

Icons Description

Icons	Description
	Slot milling and square shoulder milling
	Square shoulder rough milling
	Square shoulder finish milling
	High feed milling
	Dynamic milling cycloid milling
	Profile milling
	Chamfering and deburring

Icons	Description
	AlTiN Coating
	AlCrN Coating
	Uncoated
	30° Helix angle
	35° Helix angle
	35°/38° Helix angle
	45° Helix angle

Icons	Description
	Cylindrical shank
	Square
	Round corner
	Ball-nose
	Corner chamfer
	Chamfer
	Waved edge

Solid Carbide end Mill Denomination

M 1	1 2	00 3	- -	2 4	E 5	S 6	- -	060 7	002 8	N 9
---------------	---------------	----------------	---------------	---------------	---------------	---------------	---------------	-----------------	-----------------	---------------

1-Tool category M End mill	2-Generations 1	3-Series 00-09 Universal end mills HRC45 10-19 Universal end mills HRC55 20-29 High performance end mills HRC40 30-39 Dedicated for steel 40-49 Dedicated for aluminium alloy 50-59 Dedicated for stainless steel 60-69 Dedicated for difficult machining material 70-79 Dedicated for hardened material 80-99 others	4-Number of teeth 2,3,4,5,6.....	5-Tool type E Square B Ball nose R Round corner C Chamfer P With waved edges W Forming end mills T Taper end mill H High feed milling
-------------------------------	--------------------	--	-------------------------------------	---

6-Length	
S	Standard total length
L	Long version
XL	Super long version
XXL	Extra long version
SN	Short cutting edge
SP	Long cutting edge

7-Tool diameter
060=6.0mm
200=20.0mm

8-Chamfer / nose radius size
002=0.2mm

9-Structure type
N Straight necking
C Conical necking
P Special shank
Default: No necking

Solid Carbide end Mill M100

Eco line

Square shoulder mill with 2 cutting edges

Solid carbide end mill

Workpiece materials < HRC45

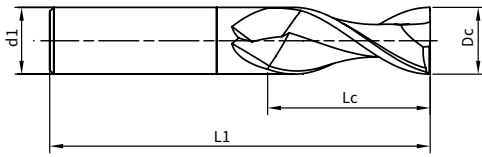

P	M	K	N	S	H	O
●●	●	●	●			

●● 1st choice ● 2nd choice

Product order	Dcmm +0.00/-0.03	d1 mm	Lc mm	L1 mm	Z	Stock
M100-2ES-010	1	4	3	50	2	●
M100-2ES-015	1.5	4	4	50	2	●
M100-2ES-020	2	4	6	50	2	●
M100-2ES-025	2.5	4	8	50	2	●
M100-2ES-030	3	4	8	50	2	●
M100-2ES-040	4	4	11	50	2	●
M100-2ES-050	5	6	13	50	2	●
M100-2ES-060	6	6	16	50	2	●
M100-2ES-070	7	8	20	60	2	●
M100-2ES-080	8	8	20	60	2	●
M100-2ES-100	10	10	25	75	2	●
M100-2ES-120	12	12	32	75	2	●
M100-2ES-140P	14	14	40	100	2	●
M100-2ES-140	14	16	40	100	2	●
M100-2ES-160	16	16	40	100	2	●
M100-2ES-180P	18	18	40	100	2	●
M100-2ES-180	18	20	40	100	2	●
M100-2ES-200	20	20	45	100	2	●

Solid Endmill

Marked: ● Stocked ○ Limited-stock

Solid Carbide end Mill M100

Eco line

Square shoulder mill with 4 cutting edges

Solid carbide end mill

Workpiece materials < HRC45

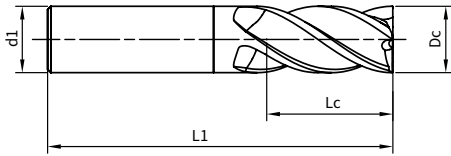

P	M	K	N	S	H	O
●●	●	●	●			

●● 1st choice ● 2nd choice

Product order	Dcmm +0.00/-0.03	d1 mm	Lc mm	L1 mm	Z	Stock
M100-4ES-010	1	4	3	50	4	●
M100-4ES-015	1.5	4	4	50	4	●
M100-4ES-020	2	4	6	50	4	●
M100-4ES-025	2.5	4	8	50	4	●
M100-4ES-030	3	4	8	50	4	●
M100-4ES-040	4	4	11	50	4	●
M100-4ES-040P	4	6	11	50	4	●
M100-4ES-050	5	6	13	50	4	●
M100-4ES-060	6	6	16	50	4	●
M100-4ES-070	7	8	20	60	4	●
M100-4ES-080	8	8	20	60	4	●
M100-4ES-090	9	10	20	75	4	●
M100-4ES-100	10	10	25	75	4	●
M100-4ES-110	11	12	30	75	4	●
M100-4ES-120	12	12	32	75	4	●
M100-4ES-140P	14	14	40	100	4	●
M100-4ES-140	14	16	40	100	4	●
M100-4ES-160	16	16	40	100	4	●
M100-4ES-180P	18	18	40	100	4	●
M100-4ES-180	18	20	40	100	4	●
M100-4ES-200	20	20	45	100	4	●

Long version

Product order	Dcmm +0.00/-0.03	d1 mm	Lc mm	L1 mm	Z	Stock
M100-4EL-030	3	4	15	60	4	●
M100-4EL-040	4	4	20	60	4	●
M100-4EL-050	5	6	25	75	4	●
M100-4EL-060	6	6	30	75	4	●
M100-4EL-080	8	8	35	100	4	●
M100-4EL-100	10	10	45	100	4	●
M100-4EL-120	12	12	45	100	4	●
M100-4EL-140	14	14	70	150	4	●
M100-4EL-160	16	16	70	150	4	●
M100-4EL-180	18	20	75	150	4	●
M100-4EL-200	20	20	75	150	4	●

Marked: ● Stocked ○ Limited-stock

Solid Carbide end Mill M100

Eco line

Ball-nose mill with 2 cutting edges

Solid carbide end mill

Workpiece materials < HRC45

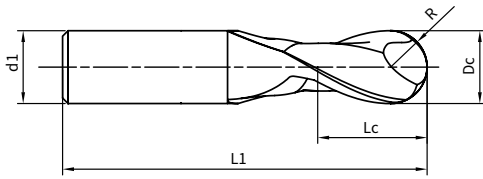

P	M	K	N	S	H	O
●●	●	●	●			

●● 1st choice ● 2nd choice

Product order	Dcmm +0.00/-0.03	R mm ≤6+0.01/>6+0.02	d1 mm	Lc mm	L1 mm	Z	Stock
M100-2BS-020	2	1	4	5	50	2	●
M100-2BS-030	3	1.5	4	6	50	2	●
M100-2BS-040	4	2	4	8	50	2	●
M100-2BS-050	5	2.5	6	10	50	2	●
M100-2BS-060	6	3	6	12	50	2	●
M100-2BS-080	8	4	8	14	60	2	●
M100-2BS-100	10	5	10	20	75	2	●
M100-2BS-120	12	6	12	24	75	2	●
M100-2BS-160	16	8	16	32	100	2	●
M100-2BS-200	20	10	20	40	100	2	●

Solid Endmill

Marked: ● Stocked ○ Limited-stock

Solid Carbide end Mill M100

Eco line

Round corner mill with 4 cutting edges

Solid carbide end mill

Workpiece materials < HRC45

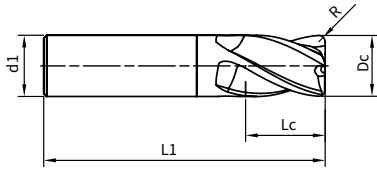

P	M	K	N	S	H	O
●●	●	●	●			

●● 1st choice ● 2nd choice

Product order	Dcmm +0.00/-0.03	R mm ±0.02	d1 mm	Lc mm	L1 mm	Z	Stock
M100-4RL-040002P	4	0.2	6	12	70	4	●
M100-4RL-040005P	4	0.5	6	12	70	4	●
M100-4RL-040010P	4	1.0	6	12	70	4	●
M100-4RL-060002	6	0.2	6	15	90	4	●
M100-4RL-060005	6	0.5	6	15	90	4	●
M100-4RL-060010	6	1.0	6	15	90	4	●
M100-4RL-080005	8	0.5	8	20	100	4	●
M100-4RL-080010	8	1.0	8	20	100	4	●
M100-4RL-080015	8	1.5	8	20	100	4	●
M100-4RL-080020	8	2.0	8	20	100	4	●
M100-4RL-100005	10	0.5	10	25	100	4	●
M100-4RL-100010	10	1.0	10	25	100	4	●
M100-4RL-100015	10	1.5	10	25	100	4	●
M100-4RL-100020	10	2.0	10	25	100	4	●
M100-4RL-100025	10	2.5	10	25	100	4	●
M100-4RL-120005	12	0.5	12	30	110	4	●
M100-4RL-120010	12	1.0	12	30	110	4	●
M100-4RL-120015	12	1.5	12	30	110	4	●
M100-4RL-120020	12	2.0	12	30	110	4	●
M100-4RL-120025	12	2.5	12	30	110	4	●
M100-4RL-120030	12	3.0	12	30	110	4	●

Marked: ● Stocked ○ Limited-stock

Solid Carbide end Mill M105

Eco line

Square shoulder mill with 4 & 6 cutting edges

Solid carbide end mill

Workpiece materials < HRC45

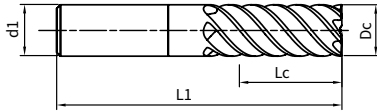

P	M	K	N	S	H	O
●●	●	●	●			

●● 1st choice ● 2nd choice

Product order	Dcmm +0.00/-0.03	d1 mm	Lc mm	L1 mm	Z	Stock
M105-4ES-040	4	4	11	50	4	●
M105-6ES-050	5	6	13	50	6	●
M105-6ES-060	6	6	16	50	6	●
M105-6ES-080	8	8	19	60	6	●
M105-6ES-100	10	10	22	75	6	●
M105-6ES-120	12	12	26	75	6	●
M105-6ES-140	14	14	30	90	6	●
M105-6ES-160	16	16	32	100	6	●
M105-6ES-180	18	18	38	100	6	●
M105-6ES-200	20	20	38	100	6	●

Long version

Product order	Dcmm +0.00/-0.03	d1 mm	Lc mm	L1 mm	Z	Stock
M105-6EL-060	6	6	25	80	6	●
M105-6EL-080	8	8	35	90	6	●
M105-6EL-100	10	10	45	100	6	●
M105-6EL-120	12	12	50	100	6	●
M105-6EL-160	16	16	65	150	6	●
M105-6EL-200	20	20	70	150	6	●

Solid Endmill

Marked: ● Stocked ○ Limited-stock

Solid Carbide end Mill M145

Eco line

Solid carbide mill

Square shoulder mill with 2 cutting edges dedicated for aluminum alloy

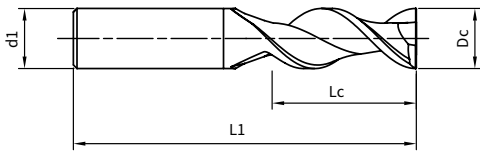

P	M	K	N	S	H	O
			●●			

●● 1st choice ● 2nd choice

Product order	Dcmm +0.00/-0.02	d1 mm	Lc mm	L1 mm	Z	Stock
M145-2ES-030	3	4	11	50	2	●
M145-2ES-040	4	4	13	50	2	●
M145-2ES-050	5	6	17	55	2	●
M145-2ES-060	6	6	17	55	2	●
M145-2ES-080	8	8	22	65	2	●
M145-2ES-100	10	10	27	70	2	●
M145-2ES-120	12	12	32	80	2	●
M145-2ES-140	14	14	37	85	2	●
M145-2ES-160	16	16	42	100	2	●
M145-2ES-180P	18	16	48	110	2	●
M145-2ES-200	20	20	48	110	2	●

Marked: ● Stocked ○ Limited-stock

Solid Carbide end Mill M145

Eco line

Solid carbide mill

Square shoulder mill with 3 cutting edges dedicated for aluminum alloy

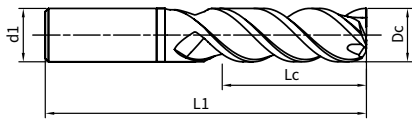

P	M	K	N	S	H	O
			●●			

●● 1st choice ● 2nd choice

Product order	Dcmm +0.00/-0.02	d1 mm	Lc mm	L1 mm	Z	Stock
M145-3ES-030	3	4	11	50	3	●
M145-3ES-040	4	4	13	50	3	●
M145-3ES-050	5	6	17	55	3	●
M145-3ES-060	6	6	17	55	3	●
M145-3ES-080	8	8	22	65	3	●
M145-3ES-100	10	10	27	70	3	●
M145-3ES-120	12	12	32	80	3	●
M145-3ES-140	14	14	37	85	3	●
M145-3ES-160	16	16	42	100	3	●
M145-3ES-180P	18	16	48	110	3	●
M145-3ES-200	20	20	48	110	3	●

Long version

Product order	Dcmm +0.00/-0.02	d1 mm	Lc mm	L1 mm	Z	Stock
M145-3EL-040	4	4	16	70	3	●
M145-3EL-060	6	6	22	70	3	●
M145-3EL-080	8	8	28	80	3	●
M145-3EL-100	10	10	32	90	3	●
M145-3EL-120	12	12	38	95	3	●
M145-3EL-160	16	16	52	110	3	●
M145-3EL-200	20	20	55	110	3	●

Marked: ● Stocked ○ Limited-stock

Solid Carbide end Mill M110

Pro line

Square shoulder mill with 2 cutting edges

Solid carbide end mill

Workpiece materials < HRC55

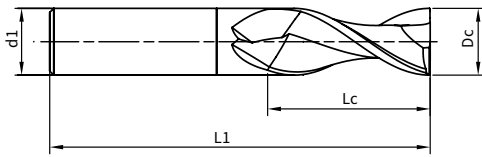

P	M	K	N	S	H	O
●●	●	●●			●	

●● 1st choice ● 2nd choice

Product order	Dcmm +0.00/-0.02	d1 mm	Lc mm	L1 mm	Z	Stock
M110-2ES-030	3	4	8	50	2	●
M110-2ES-040	4	4	11	50	2	●
M110-2ES-050	5	6	13	50	2	●
M110-2ES-060	6	6	16	50	2	●
M110-2ES-080	8	8	20	60	2	●
M110-2ES-100	10	10	25	75	2	●
M110-2ES-120	12	12	32	75	2	●
M110-2ES-140	14	16	40	100	2	●
M110-2ES-160	16	16	40	100	2	●
M110-2ES-180	18	20	40	100	2	●
M110-2ES-200	20	20	45	100	2	●

Marked: ● Stocked ○ Limited-stock

Solid Carbide end Mill M110

Pro line

Square shoulder mill with 4 cutting edges

Solid carbide end mill

Workpiece materials < HRC55

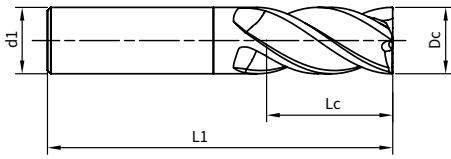

P	M	K	N	S	H	O
●●	●	●●			●	

●● 1st choice ● 2nd choice

Product order	Dcmm +0.00/-0.02	d1 mm	Lc mm	L1 mm	Z	Stock
M110-4ES-030	3	4	8	50	4	●
M110-4ES-040	4	4	11	50	4	●
M110-4ES-050	5	6	13	50	4	●
M110-4ES-060	6	6	16	50	4	●
M110-4ES-080	8	8	20	60	4	●
M110-4ES-100	10	10	25	75	4	●
M110-4ES-120	12	12	32	75	4	●
M110-4ES-140	14	16	40	100	4	●
M110-4ES-160	16	16	40	100	4	●
M110-4ES-180	18	20	40	100	4	●
M110-4ES-200	20	20	45	100	4	●

Solid Endmill

Marked: ● Stocked ○ Limited-stock

Solid Carbide end Mill M110

Pro line
Ball-nose mill with 2 cutting edges

Solid carbide end mill
Workpiece materials < HRC55

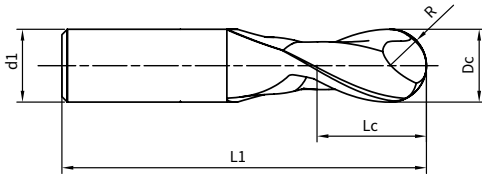

P	M	K	N	S	H	O
●●	●	●●			●	

●● 1st choice ● 2nd choice

Product order	Dcmm +0.00/-0.02	R mm ≤6+0.01/>6+0.02	d1 mm	Lc mm	L1 mm	Z	Stock
M110-2BS-030	3	1.5	4	6	50	2	●
M110-2BS-040	4	2	4	8	50	2	●
M110-2BS-050	5	2.5	6	10	50	2	●
M110-2BS-060	6	3	6	12	50	2	●
M110-2BS-070	7	3.5	8	14	60	2	●
M110-2BS-080	8	4	8	14	60	2	●
M110-2BS-090	9	4.5	10	18	75	2	●
M110-2BS-100	10	5	10	20	75	2	●
M110-2BS-120	12	6	12	24	75	2	●
M110-2BS-160	16	8	16	32	100	2	●
M110-2BS-200	20	10	20	40	100	2	●

Marked: ● Stocked ○ Limited-stock

Solid Carbide end Mill M115

Pro line

Square shoulder mill with 6 cutting edges

Solid carbide end mill

Workpiece materials < HRC55

Without central cutting edge

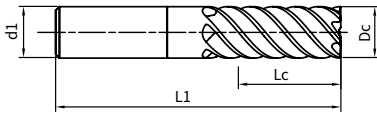

P	M	K	N	S	H	O
●●	●	●●			●	

●● 1st choice ● 2nd choice

Product order	Dcmm +0.00/-0.02	d1 mm	Lc mm	L1 mm	Z	Stock
M115-6ES-060	6	6	16	50	6	●
M115-6ES-080	8	8	19	60	6	●
M115-6ES-100	10	10	22	75	6	●
M115-6ES-120	12	12	26	75	6	●
M115-6ES-140	14	14	30	90	6	●
M115-6ES-160	16	16	32	100	6	●
M115-6ES-180	18	18	38	100	6	●

Solid Endmill

Marked: ● Stocked ○ Limited-stock

Solid Carbide end Mill M116

Pro line
 Square shoulder rough milling end mills with 4-6 cutting edges

Solid carbide end mill
 Workpiece materials < HRC40
 6 cutting edges without central cutting edge
 With waved edges design

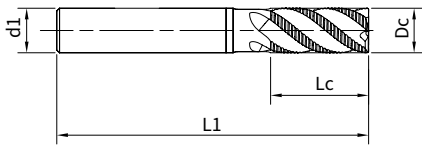

P	M	K	N	S	H	O
●●	●●	●		●		

●● 1st choice ● 2nd choice

Product order	Dcmm h10	d1 mm	Lc mm	L1 mm	Z	Stock
M116-4PS-060	6	6	13	60	4	●
M116-4PS-080	8	8	19	65	4	●
M116-4PS-100	10	10	22	70	4	●
M116-4PS-120	12	12	26	80	4	●
M116-5PS-160	16	16	42	110	5	●
M116-6PS-200	20	20	48	110	6	●

Marked: ● Stocked ○ Limited-stock

Solid Carbide end Mill M121

XP line

Square shoulder end mill with 4 cutting edges (with protective chamfers)

Solid carbide end mill

Workpiece materials < HRC40

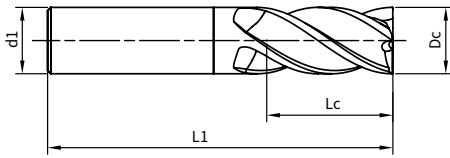

P	M	K	N	S	H	O
●●	●	●●		●		

●● 1st choice ● 2nd choice

Product order	Dcmm +0.00/-0.03	d1 mm	Chamfer mm	Lc mm	L1 mm	Z	Stock
M121 - 4CS - 040002	4	4	0.2	8	50	4	●
M121 - 4CS - 040002P	4	6	0.2	8	50	4	●
M121 - 4CS - 060002	6	6	0.2	12	50	4	●
M121 - 4CS - 080002	8	8	0.2	16	60	4	●
M121 - 4CS - 100003	10	10	0.3	20	75	4	●
M121 - 4CS - 120004	12	12	0.4	24	75	4	●
M121 - 4CS - 160004	16	16	0.4	32	100	4	●
M121 - 4CS - 200005	20	20	0.5	40	100	4	●

Long version

Product order	Dcmm +0.00/-0.03	d1 mm	Chamfer mm	Lc mm	L1 mm	Z	Stock
M121 - 4CSP - 040002P	4	6	0.2	10	50	4	●
M121 - 4CSP - 060002	6	6	0.2	15	60	4	●
M121 - 4CSP - 080002	8	8	0.2	20	70	4	●
M121 - 4CSP - 100003	10	10	0.3	25	75	4	●
M121 - 4CSP - 120004	12	12	0.4	30	80	4	●
M121 - 4CSP - 140004	14	16	0.4	35	100	4	●
M121 - 4CSP - 160004	16	16	0.4	40	100	4	●
M121 - 4CSP - 180005P	18	16	0.5	45	100	4	●
M121 - 4CSP - 200005	20	20	0.5	45	100	4	●

Marked: ● Stocked ○ Limited-stock

Solid Carbide end Mill M121

XP line
 Square shoulder mill with 4 cutting edges Long version

Solid carbide end mill
 Workpiece materials < HRC40

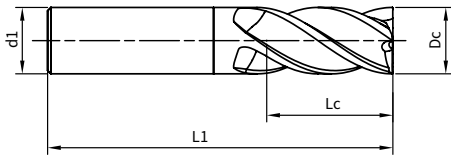

P	M	K	N	S	H	O
●●	●	●●		●		

●● 1st choice ● 2nd choice

Product order	Dcmm +0.00/-0.03	d1 mm	Lc mm	L1 mm	Z	Stock
M121 - 4ESP - 040P	4	6	10	50	4	●
M121 - 4ESP - 060	6	6	15	60	4	●
M121 - 4ESP - 080	8	8	20	70	4	●
M121 - 4ESP - 100	10	10	25	75	4	●
M121 - 4ESP - 120	12	12	30	80	4	●
M121 - 4ESP - 160	16	16	40	100	4	●
M121 - 4ESP - 200	20	20	45	100	4	●

Marked: ● Stocked ○ Limited-stock

Solid Carbide end Mill M125

XP line

Square shoulder mill with 6 cutting edges

Solid carbide end mill

Workpiece materials < HRC40

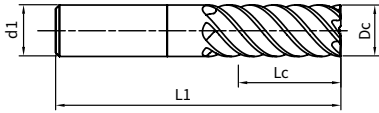

P	M	K	N	S	H	O
●●	●	●●		●		

●● 1st choice ● 2nd choice

Product order	Dcmm +0.00/-0.03	d1 mm	Lc mm	L1 mm	Z	Stock
M125 - 6ES - 060	6	6	15	60	6	●
M125 - 6ES - 080	8	8	20	70	6	●
M125 - 6ES - 100	10	10	25	75	6	●
M125 - 6ES - 120	12	12	30	80	6	●
M125 - 6ES - 160	16	16	40	100	6	●
M125 - 6ES - 200	20	20	45	100	6	●

Solid Endmill

Marked: ● Stocked ○ Limited-stock

Solid Carbide End Mill Eco Line Cutting Parameters

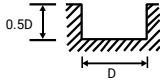
Materials					M100-2ES	Slot milling										
ISO	Material classification		Brinell hardness (HB)	Tensile strength Rm(N/mm ²)	Cutting speed Vc(m/min)	fz [mm/Tooth]										
						Mill diameter [mm]										
						2	4	6	8	10	12	14	16	20		
P	Unalloyed steel	C≤0.25%	Annealed	125	428	45~80	0.012	0.024	0.038	0.058	0.060	0.062	0.065	0.066	0.070	
		0.25<C≤0.55%	Annealed	190	639	45~75	0.012	0.024	0.038	0.058	0.060	0.062	0.065	0.066	0.070	
		0.25<C≤0.55%	Heat-treated	210	708	45~75	0.012	0.024	0.038	0.058	0.060	0.062	0.065	0.066	0.070	
		C>0.55%	Annealed	190	639	45~75	0.012	0.024	0.038	0.058	0.060	0.062	0.065	0.066	0.070	
		C>0.55%	Heat-treated	300	1013	40~60	0.010	0.020	0.034	0.045	0.052	0.055	0.055	0.057	0.060	
		Free cutting steel (short-chip)	Annealed	220	745	45~65	0.010	0.020	0.038	0.058	0.060	0.062	0.065	0.066	0.070	
		Low-alloyed steel	Annealed		175	591	45~75	0.012	0.024	0.038	0.058	0.060	0.062	0.065	0.066	0.070
	Heat-treated		300	1013	40~60	0.010	0.020	0.034	0.045	0.052	0.055	0.055	0.057	0.060		
	Heat-treated		380	1282	40~60	0.010	0.020	0.034	0.045	0.052	0.055	0.055	0.057	0.060		
	Heat-treated		430	1477	30~40	0.008	0.020	0.030	0.040	0.045	0.050	0.050	0.050	0.055		
		High-alloyed steel and high-alloyed tool steel	Annealed		200	675	45~75	0.012	0.020	0.038	0.058	0.060	0.062	0.055	0.057	0.060
	Hardened and tempered		300	1013	40~60	0.010	0.020	0.035	0.045	0.052	0.055	0.055	0.057	0.060		
	Hardened and tempered		400	1361	40~60	0.008	0.015	0.025	0.035	0.042	0.045	0.045	0.045	0.050		
		Stainless steel	Ferritic/martensitic, annealed		200	675	35~40	0.010	0.020	0.038	0.058	0.060	0.055	0.055	0.057	0.060
Martensitic, heat-treated			330	1114	30~35	0.010	0.020	0.035	0.045	0.052	0.055	0.055	0.057	0.060		
M	Stainless steel	Austenitic, quench hardened		200	675	30~35	0.007	0.020	0.035	0.043	0.050	0.053	0.055	0.057	0.058	
		Austenitic, precipitation hardened (PH)		300	1013	30	0.004	0.015	0.030	0.032	0.035	0.040	0.043	0.045	0.050	
		Austenitic/ferritic, duplex		230	778	30~35	0.007	0.020	0.035	0.043	0.050	0.053	0.055	0.057	0.058	
K	Malleable cast iron	Ferritic		200	400	55~60	0.012	0.024	0.042	0.060	0.071	0.075	0.080	0.083	0.085	
		Pearlitic		260	700	55~60	0.012	0.024	0.042	0.060	0.071	0.075	0.080	0.083	0.085	
	Grey cast iron	Low tensile strength		180	200	55~60	0.012	0.024	0.042	0.060	0.071	0.075	0.080	0.083	0.085	
		High tensile strength/austenitic		245	350	55~60	0.012	0.024	0.042	0.060	0.071	0.075	0.080	0.083	0.085	
	Nodular cast iron	Ferritic		155	400	55~60	0.010	0.020	0.038	0.050	0.060	0.065	0.072	0.075	0.075	
		Pearlitic		265	700	45~55	0.008	0.012	0.035	0.045	0.055	0.060	0.065	0.068	0.068	
		GGV(CGI)		230	400	55~60	0.010	0.020	0.038	0.050	0.060	0.065	0.072	0.075	0.075	
N	Wrought aluminium alloys	Non-aging		30	-											
		Aged		100	340											
	Cast aluminium alloys	≤ 12% Si, non-aging		75	260											
		≤ 12% Si, aged		90	310											
		> 12% Si, non-aging		130	450											
	Magnesium alloys			70	250											
	Copper and copper alloys	Unalloyed, electrolytic copper		100	340											
Brass, bronze, red brass		90	310													
Cu alloys, short-chipping		110	380													
High-tensile, Ampco alloy		300	1010													
S	Heat-resistant alloys	Fe-based	Annealed	200	680											
			Hardened	280	940											
		Ni or Co based	Annealed	250	840											
			Hardened	350	1180											
			Cast	320	1080											
	Titanium alloys	Pure titanium		200	680											
		α and β alloys, hardened		375	1260											
β alloys		410	1400													
Tungsten alloys			300	1010												
Molybdenum alloys			300	1010												
H	Hardened steel	Hardened and tempered		50HRC	-											
		Hardened and tempered		55HRC	-											
		Hardened and tempered		60HRC	-											
	Chilled cast iron	Hardened and tempered		50HRC	-											

The cutting data are average recommended values. For special applications, adjustment is needed.

Solid Carbide End Mill Eco Line Cutting Parameters

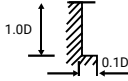
Materials					M100-4ES M100-4EL M100-4RL	Square Shoulder milling (Rough Machining) 										
ISO	Material classification		Brinell hardness (HB)	Tensile strength Rm(N/mm²)	Cutting speed Vc(m/min)	fz [mm/Tooth]										
						Mill diameter [mm]										
						2	4	6	8	10	12	14	16	20		
P	Unalloyed steel	C≤0.25%	Annealed	125	428	60~90	0.006	0.020	0.038	0.042	0.050	0.052	0.060	0.066	0.070	
		0.25 < C ≤ 0.55%	Annealed	190	639	60~85	0.006	0.020	0.038	0.042	0.050	0.052	0.060	0.066	0.070	
		0.25 < C ≤ 0.55%	Heat-treated	210	708	60~85	0.006	0.020	0.038	0.042	0.050	0.052	0.060	0.066	0.070	
		C > 0.55%	Annealed	190	639	60~85	0.006	0.020	0.038	0.042	0.050	0.052	0.060	0.066	0.070	
		C > 0.55%	Heat-treated	300	1013	55~65	0.005	0.015	0.034	0.035	0.045	0.052	0.060	0.066	0.070	
		Free cutting steel (short-chip)	Annealed	220	745	60~85	0.005	0.015	0.038	0.042	0.050	0.052	0.060	0.066	0.070	
	Low-alloyed steel	Annealed		175	591	60~85	0.006	0.020	0.038	0.042	0.050	0.052	0.060	0.066	0.070	
		Heat-treated		300	1013	45~60	0.005	0.015	0.034	0.035	0.045	0.048	0.055	0.057	0.060	
		Heat-treated		380	1282	45~60	0.005	0.015	0.034	0.035	0.045	0.048	0.055	0.057	0.060	
		Heat-treated		430	1477	40~45	0.004	0.015	0.030	0.030	0.040	0.045	0.050	0.050	0.055	
	High-alloyed steel and high-alloyed tool steel	Annealed		200	675	60~80	0.006	0.015	0.038	0.042	0.050	0.052	0.055	0.057	0.060	
		Hardened and tempered		300	1013	50~60	0.006	0.015	0.035	0.042	0.045	0.048	0.055	0.057	0.060	
		Hardened and tempered		400	1361	40~45	0.005	0.012	0.025	0.030	0.040	0.042	0.045	0.045	0.050	
	Stainless steel	Ferritic/martensitic, annealed		200	675	50~70	0.006	0.015	0.038	0.042	0.050	0.052	0.055	0.057	0.060	
		Martensitic, heat-treated		330	1114	35~45	0.005	0.015	0.035	0.035	0.045	0.048	0.055	0.057	0.060	
M	Stainless steel	Austenitic, quench hardened		200	675	35~45	0.005	0.018	0.035	0.041	0.043	0.053	0.055	0.057	0.058	
		Austenitic, precipitation hardened (PH)		300	1013	35	0.005	0.012	0.030	0.032	0.035	0.040	0.043	0.045	0.050	
		Austenitic/ferritic, duplex		230	778	35~45	0.005	0.018	0.035	0.041	0.043	0.053	0.055	0.057	0.058	
K	Malleable cast iron	Ferritic		200	400	55~60	0.012	0.024	0.042	0.065	0.071	0.075	0.080	0.083	0.080	
		Pearlitic		260	700	55~60	0.012	0.024	0.042	0.065	0.071	0.075	0.080	0.083	0.080	
	Grey cast iron	Low tensile strength		180	200	55~60	0.012	0.024	0.042	0.065	0.071	0.075	0.080	0.083	0.080	
		High tensile strength/austenitic		245	350	55~60	0.012	0.024	0.042	0.065	0.071	0.075	0.080	0.083	0.080	
	Nodular cast iron	Ferritic		155	400	55~60	0.010	0.020	0.038	0.055	0.060	0.065	0.072	0.075	0.072	
		Pearlitic		265	700	45~55	0.008	0.012	0.035	0.045	0.055	0.060	0.065	0.068	0.065	
		GGV(CGI)		230	400	55~65	0.010	0.020	0.038	0.055	0.060	0.065	0.072	0.075	0.072	
N	Wrought aluminium alloys	Non-aging		30	-											
		Aged		100	340											
	Cast aluminium alloys	≤ 12% Si, non-aging		75	260											
		≤ 12% Si, aged		90	310											
		> 12% Si, non-aging		130	450											
	Magnesium alloys				70	250										
	Copper and copper alloys	Unalloyed, electrolytic copper				100	340									
Brass, bronze, red brass				90	310											
Cu alloys, short-chipping				110	380											
High-tensile, Ampco alloy				300	1010											
S	Heat-resistant alloys	Fe-based	Annealed	200	680											
			Hardened	280	940											
		Ni or Co based	Annealed	250	840											
			Hardened	350	1180											
			Cast	320	1080											
	Titanium alloys	Pure titanium				200	680									
α and β alloys, hardened				375	1260											
β alloys				410	1400											
Tungsten alloys				300	1010											
Molybdenum alloys				300	1010											
H	Hardened steel	Hardened and tempered		50HRC	-											
		Hardened and tempered		55HRC	-											
		Hardened and tempered		60HRC	-											
	Chilled cast iron	Hardened and tempered		50HRC	-											

The cutting data are average recommended values. For special applications, adjustment is needed.

Solid Carbide End Mill Eco Line Cutting Parameters

Materials					M100-4ES,M100-4EL M100-4RL,M105-6ES M105-6EL	Square shoulder milling ^{1.5D} (Finish Machining) 									
ISO	Material classification		Brinell hardness (HB)	Tensile strength Rm(N/mm ²)	Cutting speed Vc(m/min)	fz [mm/Tooth]									
						Mill diameter [mm]									
						2	4	6	8	10	12	14	16	20	
P	Unalloyed steel	C≤0.25%	Annealed	125	428	80~100	0.006	0.020	0.030	0.038	0.045	0.052	0.058	0.062	0.070
		0.25 < C ≤ 0.55%	Annealed	190	639	75~90	0.006	0.020	0.030	0.038	0.045	0.052	0.058	0.062	0.070
		0.25 < C ≤ 0.55%	Heat-treated	210	708	75~90	0.006	0.020	0.030	0.038	0.045	0.052	0.058	0.062	0.070
		C > 0.55%	Annealed	190	639	75~90	0.006	0.020	0.030	0.038	0.045	0.052	0.058	0.062	0.070
		C > 0.55%	Heat-treated	300	1013	60~70	0.006	0.020	0.030	0.038	0.045	0.052	0.058	0.062	0.070
		Free cutting steel (short-chip)	Annealed	220	745	75~90	0.006	0.020	0.030	0.038	0.045	0.052	0.058	0.062	0.070
	Low-alloyed steel	Annealed		175	591	75~90	0.006	0.020	0.030	0.038	0.045	0.052	0.058	0.062	0.070
		Heat-treated		300	1013	60~70	0.005	0.015	0.026	0.035	0.042	0.048	0.055	0.057	0.060
		Heat-treated		380	1282	60~70	0.005	0.015	0.026	0.035	0.042	0.048	0.055	0.057	0.060
		Heat-treated		430	1477	55~60	0.005	0.015	0.025	0.030	0.040	0.045	0.050	0.050	0.055
	High-alloyed steel and high-alloyed tool steel	Annealed		200	675	75~85	0.005	0.015	0.026	0.035	0.042	0.048	0.055	0.057	0.060
		Hardened and tempered		300	1013	60~70	0.005	0.015	0.026	0.035	0.042	0.048	0.055	0.057	0.060
		Hardened and tempered		400	1361	55~60	0.004	0.012	0.025	0.030	0.040	0.045	0.050	0.050	0.055
	Stainless steel	Ferritic/martensitic, annealed		200	675	50~70	0.005	0.015	0.026	0.035	0.042	0.048	0.055	0.057	0.060
		Martensitic, heat-treated		330	1114	40~50	0.004	0.015	0.025	0.030	0.040	0.045	0.050	0.050	0.055
M	Stainless steel	Austenitic, quench hardened		200	675	40~50	0.010	0.018	0.038	0.041	0.043	0.053	0.055	0.057	0.058
		Austenitic, precipitation hardened (PH)		300	1013	40	0.005	0.012	0.030	0.032	0.035	0.040	0.043	0.045	0.050
		Austenitic/ferritic, duplex		230	778	40~50	0.005	0.018	0.038	0.041	0.043	0.053	0.055	0.057	0.058
K	Malleable cast iron	Ferritic		200	400	70~80	0.010	0.021	0.030	0.038	0.045	0.052	0.058	0.062	0.070
		Pearlitic		260	700	70~80	0.010	0.021	0.030	0.038	0.045	0.052	0.058	0.062	0.070
	Grey cast iron	Low tensile strength		180	200	70~80	0.010	0.021	0.030	0.038	0.045	0.052	0.058	0.062	0.070
		High tensile strength/austenitic		245	350	70~80	0.010	0.021	0.030	0.038	0.045	0.052	0.058	0.062	0.070
	Nodular cast iron	Ferritic		155	400	70~80	0.009	0.018	0.028	0.035	0.040	0.050	0.052	0.060	0.065
		Pearlitic		265	700	65~75	0.009	0.018	0.028	0.035	0.040	0.050	0.052	0.060	0.065
		GGV(CGI)		230	400	70~80	0.009	0.018	0.028	0.035	0.040	0.050	0.052	0.060	0.065
N	Wrought aluminium alloys	Non-aging		30	-										
		Aged		100	340										
	Cast aluminium alloys	≤ 12% Si, non-aging		75	260										
		≤ 12% Si, aged		90	310										
		> 12% Si, non-aging		130	450										
	Magnesium alloys			70	250										
	Copper and copper alloys	Unalloyed, electrolytic copper		100	340										
Brass, bronze, red brass		90	310												
Cu alloys, short-chipping		110	380												
High-tensile, Ampco alloy		300	1010												
S	Heat-resistant alloys	Fe-based	Annealed	200	680										
			Hardened	280	940										
		Ni or Co based	Annealed	250	840										
			Hardened	350	1180										
			Cast	320	1080										
	Titanium alloys	Pure titanium		200	680										
α and β alloys, hardened		375	1260												
β alloys		410	1400												
Tungsten alloys			300	1010											
Molybdenum alloys			300	1010											
H	Hardened steel	Hardened and tempered		50HRC	-										
		Hardened and tempered		55HRC	-										
		Hardened and tempered		60HRC	-										
	Chilled cast iron		Hardened and tempered		50HRC	-									

The cutting data are average recommended values. For special applications, adjustment is needed.

Solid Carbide End Mill Eco Line Cutting Parameters

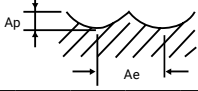
Materials					M100-2BS	Profile (Finishing) 										
ISO	Material classification		Brinell hardness (HB)	Tensile strength Rm(N/mm²)	Cutting speed Vc(m/min)	fz [mm/Tooth]										
						Mill diameter [mm]										
						2	4	6	8	10	12	14	16	20		
P	Unalloyed steel	C≤0.25%	Annealed	125	428	90~100	0.015	0.027	0.039	0.050	0.060	0.070	0.075	0.080	0.100	
		0.25 < C ≤ 0.55%	Annealed	190	639	90~100	0.015	0.027	0.039	0.050	0.060	0.070	0.075	0.080	0.100	
		0.25 < C ≤ 0.55%	Heat-treated	210	708	90~100	0.015	0.027	0.039	0.050	0.060	0.070	0.075	0.080	0.100	
		C > 0.55%	Annealed	190	639	90~100	0.015	0.027	0.039	0.050	0.060	0.070	0.075	0.080	0.100	
		C > 0.55%	Heat-treated	300	1013	80~90	0.015	0.027	0.039	0.050	0.060	0.070	0.075	0.080	0.100	
		Free cutting steel (short-chip)	Annealed	220	745	90~100	0.015	0.027	0.039	0.050	0.060	0.070	0.075	0.080	0.100	
	Low-alloyed steel	Annealed		175	591	90~100	0.015	0.027	0.039	0.050	0.060	0.070	0.075	0.080	0.100	
		Heat-treated		300	1013	80~90	0.012	0.023	0.035	0.045	0.052	0.060	0.065	0.070	0.085	
		Heat-treated		380	1282	80~90	0.010	0.020	0.030	0.041	0.045	0.050	0.055	0.060	0.070	
		Heat-treated		430	1477	80~90	0.012	0.023	0.035	0.045	0.052	0.060	0.065	0.070	0.085	
	High-alloyed steel and high-alloyed tool steel	Annealed		200	675	90~100	0.012	0.023	0.035	0.045	0.052	0.060	0.065	0.070	0.085	
		Hardened and tempered		300	1013	80~90	0.012	0.023	0.035	0.045	0.052	0.060	0.065	0.070	0.085	
		Hardened and tempered		400	1361	80~90	0.010	0.020	0.030	0.041	0.045	0.050	0.055	0.060	0.070	
	Stainless steel	Ferritic/martensitic, annealed		200	675	90~100	0.012	0.023	0.035	0.045	0.052	0.060	0.065	0.070	0.085	
		Martensitic, heat-treated		330	1114	80~90	0.012	0.023	0.035	0.045	0.052	0.060	0.065	0.070	0.085	
M	Stainless steel	Austenitic, quench hardened		200	675	90~100	0.009	0.016	0.023	0.029	0.035	0.041	0.045	0.051	0.060	
		Austenitic, precipitation hardened (PH)		300	1013	80~90	0.007	0.013	0.020	0.025	0.030	0.035	0.040	0.045	0.050	
		Austenitic/ferritic, duplex		230	778	80~90	0.009	0.016	0.023	0.029	0.035	0.041	0.045	0.051	0.060	
K	Malleable cast iron	Ferritic		200	400	90~100	0.026	0.045	0.064	0.083	0.100	0.115	0.125	0.140	0.160	
		Pearlitic		260	700	90~100	0.026	0.045	0.064	0.083	0.100	0.115	0.125	0.140	0.160	
	Grey cast iron	Low tensile strength		180	200	90~100	0.026	0.045	0.064	0.083	0.100	0.115	0.125	0.140	0.160	
		High tensile strength/austenitic		245	350	90~100	0.026	0.045	0.064	0.083	0.100	0.115	0.125	0.140	0.160	
	Nodular cast iron	Ferritic		155	400	90~100	0.020	0.035	0.050	0.060	0.080	0.090	0.105	0.120	0.140	
		Pearlitic		265	700	90~100	0.015	0.030	0.040	0.050	0.065	0.070	0.085	0.100	0.120	
		GGV(CGI)		230	400	90~100	0.020	0.035	0.050	0.060	0.080	0.090	0.105	0.120	0.140	
N	Wrought aluminium alloys	Non-aging		30	-											
		Aged		100	340											
	Cast aluminium alloys	≤ 12% Si, non-aging		75	260											
		≤ 12% Si, aged		90	310											
		> 12% Si, non-aging		130	450											
	Magnesium alloys			70	250											
	Copper and copper alloys	Unalloyed, electrolytic copper		100	340											
Brass, bronze, red brass		90	310													
Cu alloys, short-chipping		110	380													
High-tensile, Ampco alloy		300	1010													
S	Heat-resistant alloys	Fe-based	Annealed	200	680											
			Hardened	280	940											
		Ni or Co based	Annealed	250	840											
			Hardened	350	1180											
			Cast	320	1080											
	Titanium alloys	Pure titanium		200	680											
		α and β alloys, hardened		375	1260											
β alloys		410	1400													
Tungsten alloys			300	1010												
Molybdenum alloys			300	1010												
H	Hardened steel	Hardened and tempered		50HRC	-											
		Hardened and tempered		55HRC	-											
		Hardened and tempered		60HRC	-											
	Chilled cast iron	Hardened and tempered		50HRC	-											

The cutting data are average recommended values. For special applications, adjustment is needed.

Solid Carbide End Mill Eco Line Cutting Parameters

Materials					M145-2ES M145-3ES M145-3EL	Slot milling 										
ISO	Material classification		Brinell hardness (HB)	Tensile strength Rm(N/mm²)	Cutting speed Vc(m/min)	fz [mm/Tooth]										
						Mill diameter [mm]										
						2	4	6	8	10	12	14	16	20		
P	Unalloyed steel	C≤0.25%	Annealed	125	428											
		0.25 < C ≤ 0.55%	Annealed	190	639											
		0.25 < C ≤ 0.55%	Heat-treated	210	708											
		C > 0.55%	Annealed	190	639											
		C > 0.55%	Heat-treated	300	1013											
		Free cutting steel (short-chip)	Annealed	220	745											
	Low-alloyed steel	Annealed		175	591											
		Heat-treated		300	1013											
		Heat-treated		380	1282											
		Heat-treated		430	1477											
	High-alloyed steel and high-alloyed tool steel	Annealed		200	675											
		Hardened and tempered		300	1013											
		Hardened and tempered		400	1361											
	Stainless steel	Ferritic/martensitic, annealed		200	675											
Martensitic, heat-treated		330	1114													
M	Stainless steel	Austenitic, quench hardened		200	675											
		Austenitic, precipitation hardened (PH)		300	1013											
		Austenitic/ferritic, duplex		230	778											
K	Malleable cast iron	Ferritic		200	400											
		Pearlitic		260	700											
	Grey cast iron	Low tensile strength		180	200											
		High tensile strength/austenitic		245	350											
	Nodular cast iron	Ferritic		155	400											
		Pearlitic		265	700											
		GGV(CGI)		230	400											
N	Wrought aluminium alloys	Non-aging		30	-	150~200	0.030	0.050	0.065	0.085	0.100	0.120	0.140	0.160	0.180	
		Aged		100	340	120~150	0.030	0.050	0.065	0.085	0.100	0.120	0.140	0.160	0.180	
	Cast aluminium alloys	≤ 12% Si, non-aging		75	260	150~200	0.030	0.050	0.065	0.085	0.100	0.120	0.140	0.160	0.180	
		≤ 12% Si, aged		90	310	130~150	0.030	0.050	0.065	0.085	0.100	0.120	0.140	0.160	0.180	
		> 12% Si, non-aging		130	450	120~130	0.030	0.050	0.065	0.085	0.100	0.120	0.140	0.160	0.180	
	Magnesium alloys			70	250	150~200	0.030	0.050	0.065	0.085	0.100	0.120	0.140	0.160	0.180	
	Copper and copper alloys	Unalloyed, electrolytic copper		100	340	120~150	0.030	0.050	0.065	0.085	0.100	0.120	0.140	0.160	0.180	
		Brass, bronze, red brass		90	310	120~150	0.030	0.050	0.065	0.085	0.100	0.120	0.140	0.160	0.180	
Cu alloys, short-chipping		110	380	120~150	0.030	0.050	0.065	0.085	0.100	0.120	0.140	0.160	0.180			
High-tensile, Ampco alloy		300	1010													
S	Heat-resistant alloys	Fe-based	Annealed	200	680											
			Hardened	280	940											
		Ni or Co based	Annealed	250	840											
			Hardened	350	1180											
			Cast	320	1080											
	Titanium alloys	Pure titanium		200	680											
		α and β alloys, hardened		375	1260											
β alloys		410	1400													
Tungsten alloys			300	1010												
Molybdenum alloys			300	1010												
H	Hardened steel	Hardened and tempered		50HRC	-											
		Hardened and tempered		55HRC	-											
		Hardened and tempered		60HRC	-											
	Chilled cast iron	Hardened and tempered		50HRC	-											

The cutting data are average recommended values. For special applications, adjustment is needed.

Solid Carbide End Mill Eco Line Cutting Parameters

Materials					M145-2ES M145-3ES M145-3EL	Square shoulder milling 													
ISO	Material classification		Brinell hardness (HB)	Tensile strength Rm(N/mm ²)	Cutting speed Vc(m/min)	fz [mm/Tooth]													
						Mill diameter [mm]													
						2	4	6	8	10	12	14	16	20					
P	Unalloyed steel	C≤0.25%	Annealed	125	428														
		0.25 < C ≤ 0.55%	Annealed	190	639														
		0.25 < C ≤ 0.55%	Heat-treated	210	708														
		C > 0.55%	Annealed	190	639														
		C > 0.55%	Heat-treated	300	1013														
		Free cutting steel (short-chip)	Annealed	220	745														
	Low-alloyed steel	Annealed		175	591														
		Heat-treated		300	1013														
		Heat-treated		380	1282														
		Heat-treated		430	1477														
	High-alloyed steel and high-alloyed tool steel	Annealed		200	675														
		Hardened and tempered		300	1013														
		Hardened and tempered		400	1361														
	Stainless steel	Ferritic/martensitic, annealed		200	675														
Martensitic, heat-treated		330	1114																
M	Stainless steel	Austenitic, quench hardened		200	675														
		Austenitic, precipitation hardened (PH)		300	1013														
		Austenitic/ferritic, duplex		230	778														
K	Malleable cast iron	Ferritic		200	400														
		Pearlitic		260	700														
	Grey cast iron	Low tensile strength		180	200														
		High tensile strength/austenitic		245	350														
	Nodular cast iron	Ferritic		155	400														
		Pearlitic		265	700														
		GGV(CGI)		230	400														
N	Wrought aluminium alloys	Non-aging		30	-	150~200	0.025	0.040	0.055	0.065	0.090	0.110	0.120	0.140	0.160				
		Aged		100	340	120~150	0.025	0.040	0.055	0.065	0.090	0.110	0.120	0.140	0.160				
	Cast aluminium alloys	≤ 12% Si, non-aging		75	260	150~200	0.025	0.040	0.055	0.065	0.090	0.110	0.120	0.140	0.160				
		≤ 12% Si, aged		90	310	120~150	0.025	0.040	0.055	0.065	0.090	0.110	0.120	0.140	0.160				
		> 12% Si, non-aging		130	450	120~150	0.025	0.040	0.055	0.065	0.090	0.110	0.120	0.140	0.160				
	Magnesium alloys			70	250	150~170	0.025	0.040	0.055	0.065	0.090	0.110	0.120	0.140	0.160				
	Copper and copper alloys	Unalloyed, electrolytic copper		100	340	120~150	0.025	0.040	0.055	0.065	0.090	0.110	0.120	0.140	0.160				
		Brass, bronze, red brass		90	310	120~150	0.025	0.040	0.055	0.065	0.090	0.110	0.120	0.140	0.160				
Cu alloys, short-chipping		110	380	120~150	0.025	0.040	0.055	0.065	0.090	0.110	0.120	0.140	0.160						
High-tensile, Ampco alloy		300	1010																
S	Heat-resistant alloys	Fe-based	Annealed	200	680														
			Hardened	280	940														
		Ni or Co based	Annealed	250	840														
			Hardened	350	1180														
			Cast	320	1080														
	Titanium alloys	Pure titanium		200	680														
α and β alloys, hardened		375	1260																
β alloys		410	1400																
Tungsten alloys			300	1010															
Molybdenum alloys			300	1010															
H	Hardened steel	Hardened and tempered		50HRC	-														
		Hardened and tempered		55HRC	-														
		Hardened and tempered		60HRC	-														
	Chilled cast iron	Hardened and tempered		50HRC	-														

The cutting data are average recommended values. For special applications, adjustment is needed.

Solid Carbide End Mill Pro Line Cutting Parameters

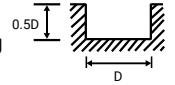
Materials					M110-2ES	Slot milling 								
ISO	Material classification		Brinell hardness (HB)	Tensile strength Rm(N/mm²)	Cutting speed Vc(m/min)	fz [mm/Tooth]								
						Mill diameter [mm]								
						4	6	8	10	12	14	16	20	
P	Unalloyed steel	C≤0.25%	Annealed	125	428	45~80	0.024	0.038	0.058	0.060	0.062	0.065	0.066	0.070
		0.25 < C ≤ 0.55%	Annealed	190	639	45~75	0.024	0.038	0.058	0.060	0.062	0.065	0.066	0.070
		0.25 < C ≤ 0.55%	Heat-treated	210	708	45~75	0.024	0.038	0.058	0.060	0.062	0.065	0.066	0.070
		C > 0.55%	Annealed	190	639	55~75	0.024	0.038	0.058	0.060	0.062	0.065	0.066	0.070
		C > 0.55%	Heat-treated	300	1013	45~60	0.020	0.034	0.045	0.052	0.055	0.055	0.057	0.060
		Free cutting steel (short-chip)	Annealed	220	745	50~65	0.020	0.038	0.058	0.060	0.062	0.065	0.066	0.070
	Low-alloyed steel	Annealed		175	591	55~75	0.024	0.038	0.058	0.060	0.062	0.065	0.066	0.070
		Heat-treated		300	1013	50~60	0.020	0.034	0.045	0.052	0.055	0.055	0.057	0.060
		Heat-treated		380	1282	50~60	0.020	0.034	0.045	0.052	0.055	0.055	0.057	0.060
		Heat-treated		430	1477	35~40	0.020	0.030	0.040	0.045	0.050	0.050	0.050	0.055
	High-alloyed steel and high-alloyed tool steel	Annealed		200	675	50~75	0.020	0.038	0.058	0.060	0.062	0.055	0.057	0.060
		Hardened and tempered		300	1013	45~60	0.020	0.035	0.045	0.052	0.055	0.055	0.057	0.060
		Hardened and tempered		400	1361	45~60	0.015	0.025	0.035	0.042	0.045	0.045	0.045	0.050
	Stainless steel	Ferritic/martensitic, annealed		200	675	40~50	0.020	0.038	0.058	0.060	0.055	0.055	0.057	0.060
		Martensitic, heat-treated		330	1114	35~45	0.020	0.035	0.045	0.052	0.055	0.055	0.057	0.060
M	Stainless steel	Austenitic, quench hardened		200	675	35~40	0.020	0.035	0.043	0.050	0.053	0.055	0.057	0.058
		Austenitic, precipitation hardened (PH)		300	1013	35	0.015	0.030	0.032	0.035	0.040	0.043	0.045	0.050
		Austenitic/ferritic, duplex		230	778	35~40	0.020	0.035	0.043	0.050	0.053	0.055	0.057	0.058
K	Malleable cast iron	Ferritic		200	400	65~80	0.024	0.042	0.060	0.071	0.075	0.080	0.083	0.085
		Pearlitic		260	700	65~80	0.024	0.042	0.060	0.071	0.075	0.080	0.083	0.085
	Grey cast iron	Low tensile strength		180	200	65~80	0.024	0.042	0.060	0.071	0.075	0.080	0.083	0.085
		High tensile strength/austenitic		245	350	65~80	0.024	0.042	0.060	0.071	0.075	0.080	0.083	0.085
	Nodular cast iron	Ferritic		155	400	65~80	0.020	0.038	0.050	0.060	0.065	0.072	0.075	0.075
		Pearlitic		265	700	55~65	0.012	0.035	0.045	0.055	0.060	0.065	0.068	0.068
		GGV(CGI)		230	400	65~75	0.020	0.038	0.050	0.060	0.065	0.072	0.075	0.075
N	Wrought aluminium alloys	Non-aging		30	-									
		Aged		100	340									
	Cast aluminium alloys	≤ 12% Si, non-aging		75	260									
		≤ 12% Si, aged		90	310									
		> 12% Si, non-aging		130	450									
	Magnesium alloys			70	250									
	Copper and copper alloys	Unalloyed, electrolytic copper		100	340									
Brass, bronze, red brass		90	310											
Cu alloys, short-chipping		110	380											
High-tensile, Ampco alloy		300	1010											
S	Heat-resistant alloys	Fe-based	Annealed	200	680									
			Hardened	280	940									
		Ni or Co based	Annealed	250	840									
			Hardened	350	1180									
			Cast	320	1080									
	Titanium alloys	Pure titanium		200	680									
α and β alloys, hardened		375	1260											
β alloys		410	1400											
Tungsten alloys			300	1010										
Molybdenum alloys			300	1010										
H	Hardened steel	Hardened and tempered		50HRC	-	40~45	0.020	0.030	0.040	0.050	0.050	0.060	0.070	0.090
		Hardened and tempered		55HRC	-	35~40	0.020	0.030	0.040	0.050	0.050	0.060	0.070	0.090
		Hardened and tempered		60HRC	-									
	Chilled cast iron		Hardened and tempered		50HRC	-	40~45	0.020	0.030	0.040	0.050	0.050	0.060	0.070

The cutting data are average recommended values. For special applications, adjustment is needed.

Solid Carbide End Mill Pro Line Cutting Parameters

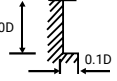
Materials						M110-2ES	Square shoulder milling (Rough Machining) 								
ISO	Material classification		Brinell hardness (HB)	Tensile strength Rm(N/mm²)	Cutting speed Vc(m/min)	fz [mm/Tooth]									
						Mill diameter [mm]									
						4	6	8	10	12	14	16	20		
P	Unalloyed steel	C≤0.25%	Annealed	125	428	70~90	0.020	0.038	0.042	0.050	0.052	0.060	0.066	0.070	
		0.25 < C ≤ 0.55%	Annealed	190	639	70~85	0.020	0.038	0.042	0.050	0.052	0.060	0.066	0.070	
		0.25 < C ≤ 0.55%	Heat-treated	210	708	70~85	0.020	0.038	0.042	0.050	0.052	0.060	0.066	0.070	
		C > 0.55%	Annealed	190	639	70~85	0.020	0.038	0.042	0.050	0.052	0.060	0.066	0.070	
		C > 0.55%	Heat-treated	300	1013	60~65	0.015	0.034	0.035	0.045	0.052	0.060	0.066	0.070	
		Free cutting steel (short-chip)	Annealed	220	745	70~85	0.015	0.038	0.042	0.050	0.052	0.060	0.066	0.070	
	Low-alloyed steel	Annealed		175	591	70~85	0.020	0.038	0.042	0.050	0.052	0.060	0.066	0.070	
		Heat-treated		300	1013	50~60	0.015	0.034	0.035	0.045	0.048	0.055	0.057	0.060	
		Heat-treated		380	1282	50~60	0.015	0.034	0.035	0.045	0.048	0.055	0.057	0.060	
		Heat-treated		430	1477	45~50	0.015	0.030	0.030	0.040	0.045	0.050	0.050	0.055	
	High-alloyed steel and high-alloyed tool steel	Annealed		200	675	70~80	0.015	0.038	0.042	0.050	0.052	0.055	0.057	0.060	
		Hardened and tempered		300	1013	55~65	0.015	0.035	0.042	0.045	0.048	0.055	0.057	0.060	
		Hardened and tempered		400	1361	45~50	0.012	0.025	0.030	0.040	0.042	0.045	0.045	0.050	
	Stainless steel	Ferritic/martensitic, annealed		200	675	55~70	0.015	0.038	0.042	0.050	0.052	0.055	0.057	0.060	
		Martensitic, heat-treated		330	1114	40~55	0.015	0.035	0.035	0.045	0.048	0.055	0.057	0.060	
M	Stainless steel	Austenitic, quench hardened		200	675	35~45	0.018	0.038	0.041	0.043	0.053	0.055	0.057	0.058	
		Austenitic, precipitation hardened (PH)		300	1013	35	0.012	0.030	0.032	0.035	0.040	0.043	0.045	0.050	
		Austenitic/ferritic, duplex		230	778	35~45	0.018	0.038	0.041	0.043	0.053	0.055	0.057	0.058	
K	Malleable cast iron	Ferritic		200	400	65~75	0.024	0.042	0.065	0.071	0.075	0.080	0.083	0.080	
		Pearlitic		260	700	65~75	0.024	0.042	0.065	0.071	0.075	0.080	0.083	0.080	
	Grey cast iron	Low tensile strength		180	200	65~75	0.024	0.042	0.065	0.071	0.075	0.080	0.083	0.080	
		High tensile strength/austenitic		245	350	65~75	0.024	0.042	0.065	0.071	0.075	0.080	0.083	0.080	
	Nodular cast iron	Ferritic		155	400	65~75	0.020	0.038	0.055	0.060	0.065	0.072	0.075	0.072	
		Pearlitic		265	700	45~55	0.012	0.035	0.045	0.055	0.060	0.065	0.068	0.065	
		GGV(CGI)		230	400	65~75	0.020	0.038	0.055	0.060	0.065	0.072	0.075	0.072	
N	Wrought aluminium alloys	Non-aging		30	-										
		Aged		100	340										
	Cast aluminium alloys	≤ 12% Si, non-aging		75	260										
		≤ 12% Si, aged		90	310										
		> 12% Si, non-aging		130	450										
	Magnesium alloys				70	250									
	Copper and copper alloys	Unalloyed, electrolytic copper				100	340								
Brass, bronze, red brass				90	310										
Cu alloys, short-chipping				110	380										
High-tensile, Ampco alloy				300	1010										
S	Heat-resistant alloys	Fe-based	Annealed	200	680										
			Hardened	280	940										
		Ni or Co based	Annealed	250	840										
			Hardened	350	1180										
			Cast	320	1080										
	Titanium alloys	Pure titanium				200	680								
		α and β alloys, hardened				375	1260								
β alloys				410	1400										
Tungsten alloys				300	1010										
Molybdenum alloys				300	1010										
H	Hardened steel	Hardened and tempered		50HRC	-	40~45	0.020	0.030	0.040	0.050	0.050	0.060	0.070	0.090	
		Hardened and tempered		55HRC	-	35~40	0.020	0.030	0.040	0.050	0.050	0.060	0.070	0.090	
		Hardened and tempered		60HRC	-										
	Chilled cast iron		Hardened and tempered		50HRC	-	40~45	0.020	0.030	0.040	0.050	0.050	0.060	0.070	0.090

The cutting data are average recommended values. For special applications, adjustment is needed.

Solid Carbide End Mill Pro Line Cutting Parameters

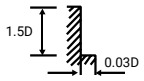
Materials					M110-4ES M115-6ES	Square shoulder milling (Finish Machining) 								
ISO	Material classification		Brinell hardness (HB)	Tensile strength Rm(N/mm²)	Cutting speed Vc(m/min)	fz [mm/Tooth]								
						Mill diameter [mm]								
						4	6	8	10	12	14	16	20	
P	Unalloyed steel	C≤0.25%	Annealed	125	428	85~100	0.020	0.030	0.038	0.045	0.052	0.058	0.062	0.070
		0.25 < C ≤ 0.55%	Annealed	190	639	75~90	0.020	0.030	0.038	0.045	0.052	0.058	0.062	0.070
		0.25 < C ≤ 0.55%	Heat-treated	210	708	75~90	0.020	0.030	0.038	0.045	0.052	0.058	0.062	0.070
		C > 0.55%	Annealed	190	639	75~90	0.020	0.030	0.038	0.045	0.052	0.058	0.062	0.070
		C > 0.55%	Heat-treated	300	1013	65~70	0.020	0.030	0.038	0.045	0.052	0.058	0.062	0.070
		Free cutting steel (short-chip)	Annealed	220	745	75~90	0.020	0.030	0.038	0.045	0.052	0.058	0.062	0.070
	Low-alloyed steel	Annealed		175	591	75~90	0.020	0.030	0.038	0.045	0.052	0.058	0.062	0.070
		Heat-treated		300	1013	60~70	0.015	0.026	0.035	0.042	0.048	0.055	0.057	0.060
		Heat-treated		380	1282	60~70	0.015	0.026	0.035	0.042	0.048	0.055	0.057	0.060
		Heat-treated		430	1477	55~60	0.015	0.025	0.030	0.040	0.045	0.050	0.050	0.055
	High-alloyed steel and high-alloyed tool steel	Annealed		200	675	75~85	0.015	0.026	0.035	0.042	0.048	0.055	0.057	0.060
		Hardened and tempered		300	1013	60~70	0.015	0.026	0.035	0.042	0.048	0.055	0.057	0.060
		Hardened and tempered		400	1361	55~60	0.012	0.025	0.030	0.040	0.045	0.050	0.050	0.055
	Stainless steel	Ferritic/martensitic, annealed		200	675	50~70	0.015	0.026	0.035	0.042	0.048	0.055	0.057	0.060
Martensitic, heat-treated		330	1114	40~50	0.015	0.025	0.030	0.040	0.045	0.050	0.050	0.055		
M	Stainless steel	Austenitic, quench hardened		200	675	40~50	0.018	0.038	0.041	0.043	0.053	0.055	0.057	0.058
		Austenitic, precipitation hardened (PH)		300	1013	40	0.012	0.030	0.032	0.035	0.040	0.043	0.045	0.050
		Austenitic/ferritic, duplex		230	778	40~50	0.018	0.038	0.041	0.043	0.053	0.055	0.057	0.058
K	Malleable cast iron	Ferritic		200	400	75~85	0.021	0.030	0.038	0.045	0.052	0.058	0.062	0.070
		Pearlitic		260	700	75~85	0.021	0.030	0.038	0.045	0.052	0.058	0.062	0.070
	Grey cast iron	Low tensile strength		180	200	75~85	0.021	0.030	0.038	0.045	0.052	0.058	0.062	0.070
		High tensile strength/austenitic		245	350	75~85	0.021	0.030	0.038	0.045	0.052	0.058	0.062	0.070
	Nodular cast iron	Ferritic		155	400	75~85	0.018	0.028	0.035	0.040	0.050	0.052	0.060	0.065
		Pearlitic		265	700	65~75	0.018	0.028	0.035	0.040	0.050	0.052	0.060	0.065
		GGV(CGI)		230	400	75~85	0.018	0.028	0.035	0.040	0.050	0.052	0.060	0.065
N	Wrought aluminium alloys	Non-aging		30	-									
		Aged		100	340									
	Cast aluminium alloys	≤ 12% Si, non-aging		75	260									
		≤ 12% Si, aged		90	310									
		> 12% Si, non-aging		130	450									
	Magnesium alloys			70	250									
	Copper and copper alloys	Unalloyed, electrolytic copper		100	340									
Brass, bronze, red brass		90	310											
Cu alloys, short-chipping		110	380											
High-tensile, Ampco alloy		300	1010											
S	Heat-resistant alloys	Fe-based	Annealed	200	680									
			Hardened	280	940									
		Ni or Co based	Annealed	250	840									
			Hardened	350	1180									
			Cast	320	1080									
	Titanium alloys	Pure titanium		200	680									
		α and β alloys, hardened		375	1260									
β alloys		410	1400											
Tungsten alloys			300	1010										
Molybdenum alloys			300	1010										
H	Hardened steel	Hardened and tempered		50HRC	-	40~45	0.020	0.030	0.040	0.050	0.050	0.060	0.070	0.090
		Hardened and tempered		55HRC	-	35~40	0.020	0.030	0.041	0.045	0.050	0.055	0.070	0.090
		Hardened and tempered		60HRC	-									
	Chilled cast iron	Hardened and tempered		50HRC	-	40~45	0.020	0.030	0.040	0.050	0.050	0.060	0.070	0.090

The cutting data are average recommended values. For special applications, adjustment is needed.

Solid Carbide End Mill Pro Line Cutting Parameters

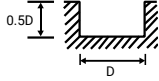
Materials				M116-4PS		Slot milling							
ISO	Material classification		Brinell hardness (HB)	Tensile strength Rm(N/mm ²)	Cutting speed Vc(m/min)	fz [mm/Tooth]							
						Mill diameter [mm]							
						6	8	10	12	16	20		
P	Unalloyed steel	C≤0.25%	Annealed	125	428	80~100	0.035	0.055	0.069	0.082	0.088	0.089	
		0.25 < C ≤ 0.55%	Annealed	190	639	75~90	0.035	0.055	0.069	0.082	0.088	0.089	
		0.25 < C ≤ 0.55%	Heat-treated	210	708	75~90	0.035	0.055	0.069	0.082	0.088	0.089	
		C > 0.55%	Annealed	190	639	75~90	0.035	0.055	0.069	0.082	0.088	0.089	
		C > 0.55%	Heat-treated	300	1013	60~70	0.030	0.050	0.060	0.072	0.075	0.078	
		Free cutting steel (short-chip)	Annealed	220	745	75~90	0.035	0.055	0.069	0.082	0.088	0.089	
	Low-alloyed steel	Annealed		175	591	75~90	0.035	0.055	0.069	0.082	0.088	0.089	
		Heat-treated		300	1013	60~70	0.030	0.050	0.060	0.072	0.075	0.078	
		Heat-treated		380	1282	60~70	0.030	0.050	0.060	0.072	0.075	0.078	
		Heat-treated		430	1477	55~60	0.030	0.050	0.060	0.072	0.075	0.078	
	High-alloyed steel and high-alloyed tool steel	Annealed		200	675	75~85	0.035	0.055	0.069	0.082	0.088	0.089	
		Hardened and tempered		300	1013	60~70	0.030	0.050	0.060	0.072	0.075	0.078	
		Hardened and tempered		400	1361	55~60	0.030	0.050	0.060	0.072	0.075	0.078	
	Stainless steel	Ferritic/martensitic, annealed		200	675	45~50	0.035	0.055	0.069	0.082	0.088	0.089	
Martensitic, heat-treated		330	1114	40~50	0.030	0.050	0.060	0.072	0.075	0.078			
M	Stainless steel	Austenitic, quench hardened		200	675	40~50	0.020	0.045	0.051	0.055	0.062	0.075	
		Austenitic, precipitation hardened (PH)		300	1013	35	0.020	0.045	0.051	0.055	0.062	0.075	
		Austenitic/ferritic, duplex		230	778	40~50	0.020	0.045	0.051	0.055	0.062	0.075	
K	Malleable cast iron	Ferritic		200	400	70~80	0.035	0.055	0.069	0.082	0.088	0.089	
		Pearlitic		260	700	70~80	0.035	0.055	0.069	0.082	0.088	0.089	
	Grey cast iron	Low tensile strength		180	200	70~80	0.035	0.055	0.069	0.082	0.088	0.089	
		High tensile strength/austenitic		245	350	70~80	0.035	0.055	0.069	0.082	0.088	0.089	
	Nodular cast iron	Ferritic		155	400	70~80	0.035	0.055	0.069	0.082	0.088	0.089	
		Pearlitic		265	700	65~75	0.035	0.055	0.069	0.082	0.088	0.089	
		GGV(CGI)		230	400	70~80	0.035	0.055	0.069	0.082	0.088	0.089	
N	Wrought aluminium alloys	Non-aging		30	-								
		Aged		100	340								
	Cast aluminium alloys	≤ 12% Si, non-aging		75	260								
		≤ 12% Si, aged		90	310								
		> 12% Si, non-aging		130	450								
	Magnesium alloys				70	250							
	Copper and copper alloys	Unalloyed, electrolytic copper		100	340								
Brass, bronze, red brass		90	310										
Cu alloys, short-chipping		110	380										
High-tensile, Ampco alloy		300	1010										
S	Heat-resistant alloys	Fe-based	Annealed	200	680	45~55	0.025	0.050	0.055	0.060	0.070	0.075	
			Hardened	280	940	35~45	0.020	0.045	0.051	0.055	0.062	0.075	
		Ni or Co based	Annealed	250	840	45~55	0.020	0.045	0.051	0.055	0.062	0.075	
			Hardened	350	1180	35~45	0.020	0.045	0.051	0.055	0.062	0.075	
			Cast	320	1080	35~45	0.020	0.045	0.051	0.055	0.062	0.075	
	Titanium alloys	Pure titanium		200	680	45~55	0.020	0.045	0.051	0.055	0.062	0.075	
		α and β alloys, hardened		375	1260	30~40	0.015	0.035	0.041	0.045	0.052	0.065	
		β alloys		410	1400	20~25	0.015	0.035	0.041	0.045	0.052	0.065	
	Tungsten alloys				300	1010	35~45	0.020	0.045	0.051	0.055	0.062	0.075
	Molybdenum alloys				300	1010	35~45	0.020	0.045	0.051	0.055	0.062	0.075
H	Hardened steel	Hardened and tempered		50HRC	-								
		Hardened and tempered		55HRC	-								
		Hardened and tempered		60HRC	-								
	Chilled cast iron		Hardened and tempered		50HRC	-							

The cutting data are average recommended values. For special applications, adjustment is needed.

Solid Carbide End Mill Pro Line Cutting Parameters

Materials					M116-4PS	Square shoulder milling 						
ISO	Material classification		Brinell hardness (HB)	Tensile strength Rm(N/mm²)	Cutting speed Vc(m/min)	fz [mm/Tooth]						
						Mill diameter [mm]						
						6	8	10	12	16	20	
P	Unalloyed steel	C≤0.25%	Annealed	125	428	95~120	0.035	0.055	0.069	0.082	0.088	0.089
		0.25 < C ≤ 0.55%	Annealed	190	639	85~100	0.035	0.055	0.069	0.082	0.088	0.089
		0.25 < C ≤ 0.55%	Heat-treated	210	708	85~100	0.035	0.055	0.069	0.082	0.088	0.089
		C > 0.55%	Annealed	190	639	85~100	0.035	0.055	0.069	0.082	0.088	0.089
		C > 0.55%	Heat-treated	300	1013	70~85	0.030	0.050	0.060	0.072	0.075	0.078
		Free cutting steel (short-chip)	Annealed	220	745	85~100	0.035	0.055	0.069	0.082	0.088	0.089
	Low-alloyed steel	Annealed		175	591	85~100	0.035	0.055	0.069	0.082	0.088	0.089
		Heat-treated		300	1013	70~85	0.030	0.050	0.060	0.072	0.075	0.078
		Heat-treated		380	1282	70~85	0.030	0.050	0.060	0.072	0.075	0.078
		Heat-treated		430	1477	60~70	0.030	0.050	0.060	0.072	0.075	0.078
	High-alloyed steel and high-alloyed tool steel	Annealed		200	675	85~100	0.035	0.055	0.069	0.082	0.088	0.089
		Hardened and tempered		300	1013	70~80	0.030	0.050	0.060	0.072	0.075	0.078
		Hardened and tempered		400	1361	65~75	0.030	0.050	0.060	0.072	0.075	0.078
	Stainless steel	Ferritic/martensitic, annealed		200	675	50~60	0.035	0.055	0.069	0.082	0.088	0.089
Martensitic, heat-treated		330	1114	45~55	0.030	0.050	0.060	0.072	0.075	0.078		
M	Stainless steel	Austenitic, quench hardened		200	675	45~55	0.020	0.045	0.051	0.055	0.062	0.075
		Austenitic, precipitation hardened (PH)		300	1013	40	0.020	0.045	0.051	0.055	0.062	0.075
		Austenitic/ferritic, duplex		230	778	45~55	0.020	0.045	0.051	0.055	0.062	0.075
K	Malleable cast iron	Ferritic		200	400	80~90	0.035	0.055	0.069	0.082	0.088	0.089
		Pearlitic		260	700	80~90	0.035	0.055	0.069	0.082	0.088	0.089
	Grey cast iron	Low tensile strength		180	200	80~90	0.035	0.055	0.069	0.082	0.088	0.089
		High tensile strength/austenitic		245	350	80~90	0.035	0.055	0.069	0.082	0.088	0.089
	Nodular cast iron	Ferritic		155	400	80~90	0.035	0.055	0.069	0.082	0.088	0.089
		Pearlitic		265	700	70~85	0.035	0.055	0.069	0.082	0.088	0.089
GGV(CGI)			230	400	80~90	0.035	0.055	0.069	0.082	0.088	0.089	
N	Wrought aluminium alloys	Non-aging		30	-							
		Aged		100	340							
	Cast aluminium alloys	≤ 12% Si, non-aging		75	260							
		≤ 12% Si, aged		90	310							
		> 12% Si, non-aging		130	450							
	Magnesium alloys		70	250								
	Copper and copper alloys	Unalloyed, electrolytic copper		100	340							
Brass, bronze, red brass		90	310									
Cu alloys, short-chipping		110	380									
High-tensile, Ampco alloy		300	1010									
S	Heat-resistant alloys	Fe-based	Annealed	200	680	50~65	0.025	0.050	0.055	0.060	0.070	0.075
			Hardened	280	940	40~50	0.020	0.045	0.051	0.055	0.062	0.075
		Ni or Co based	Annealed	250	840	50~60	0.020	0.045	0.051	0.055	0.062	0.075
			Hardened	350	1180	40~45	0.020	0.045	0.051	0.055	0.062	0.075
			Cast	320	1080	40~45	0.020	0.045	0.051	0.055	0.062	0.075
	Titanium alloys	Pure titanium		200	680	50~60	0.020	0.045	0.051	0.055	0.062	0.075
		α and β alloys, hardened		375	1260	35~45	0.015	0.035	0.041	0.045	0.052	0.065
		β alloys		410	1400	25~30	0.015	0.035	0.041	0.045	0.052	0.065
	Tungsten alloys		300	1010	40~45	0.020	0.045	0.051	0.055	0.062	0.075	
	Molybdenum alloys		300	1010	40~45	0.020	0.045	0.051	0.055	0.062	0.075	
H	Hardened steel	Hardened and tempered		50HRC	-							
		Hardened and tempered		55HRC	-							
		Hardened and tempered		60HRC	-							
	Chilled cast iron		Hardened and tempered		50HRC	-						

The cutting data are average recommended values. For special applications, adjustment is needed.

Solid Carbide End Mill Pro Line Cutting Parameters

Materials						M110-2BS	Profile (Finishing)								
ISO	Material classification		Brinell hardness (HB)	Tensile strength Rm(N/mm²)	Cutting speed Vc(m/min)	fz [mm/Tooth]									
						Mill diameter [mm]									
						4	6	8	10	12	14	16	20		
P	Unalloyed steel	C ≤ 0.25%	Annealed	125	428	90~100	0.027	0.039	0.050	0.060	0.070	0.075	0.080	0.100	
		0.25 < C ≤ 0.55%	Annealed	190	639	90~100	0.027	0.039	0.050	0.060	0.070	0.075	0.080	0.100	
		0.25 < C ≤ 0.55%	Heat-treated	210	708	90~100	0.027	0.039	0.050	0.060	0.070	0.075	0.080	0.100	
		C > 0.55%	Annealed	190	639	90~100	0.027	0.039	0.050	0.060	0.070	0.075	0.080	0.100	
		C > 0.55%	Heat-treated	300	1013	80~90	0.027	0.039	0.050	0.060	0.070	0.075	0.080	0.100	
		Free cutting steel (short-chip)	Annealed	220	745	90~100	0.027	0.039	0.050	0.060	0.070	0.075	0.080	0.100	
	Low-alloyed steel	Annealed		175	591	90~100	0.027	0.039	0.050	0.060	0.070	0.075	0.080	0.100	
		Heat-treated		300	1013	80~90	0.023	0.035	0.045	0.052	0.060	0.065	0.070	0.085	
		Heat-treated		380	1282	80~90	0.020	0.030	0.041	0.045	0.050	0.055	0.060	0.070	
		Heat-treated		430	1477	80~90	0.023	0.035	0.045	0.052	0.060	0.065	0.070	0.085	
	High-alloyed steel and high-alloyed tool steel	Annealed		200	675	90~100	0.023	0.035	0.045	0.052	0.060	0.065	0.070	0.085	
		Hardened and tempered		300	1013	80~90	0.023	0.035	0.045	0.052	0.060	0.065	0.070	0.085	
		Hardened and tempered		400	1361	80~90	0.020	0.030	0.041	0.045	0.050	0.055	0.060	0.070	
	Stainless steel	Ferritic/martensitic, annealed		200	675	90~100	0.023	0.035	0.045	0.052	0.060	0.065	0.070	0.085	
Martensitic, heat-treated		330	1114	80~90	0.023	0.035	0.045	0.052	0.060	0.065	0.070	0.085			
M	Stainless steel	Austenitic, quench hardened		200	675	90~100	0.016	0.023	0.029	0.035	0.041	0.045	0.051	0.060	
		Austenitic, precipitation hardened (PH)		300	1013	80~90	0.013	0.020	0.025	0.030	0.035	0.040	0.045	0.050	
		Austenitic/ferritic, duplex		230	778	80~90	0.016	0.023	0.029	0.035	0.041	0.045	0.051	0.060	
K	Malleable cast iron	Ferritic		200	400	90~100	0.045	0.064	0.083	0.100	0.115	0.125	0.140	0.160	
		Pearlitic		260	700	90~100	0.045	0.064	0.083	0.100	0.115	0.125	0.140	0.160	
	Grey cast iron	Low tensile strength		180	200	90~100	0.045	0.064	0.083	0.100	0.115	0.125	0.140	0.160	
		High tensile strength/austenitic		245	350	90~100	0.045	0.064	0.083	0.100	0.115	0.125	0.140	0.160	
	Nodular cast iron	Ferritic		155	400	90~100	0.035	0.050	0.060	0.080	0.090	0.105	0.120	0.140	
		Pearlitic		265	700	90~100	0.030	0.040	0.050	0.065	0.070	0.085	0.100	0.120	
		GGV(CGI)		230	400	90~100	0.035	0.050	0.060	0.080	0.090	0.105	0.120	0.140	
N	Wrought aluminium alloys	Non-aging		30	-										
		Aged		100	340										
	Cast aluminium alloys	≤ 12% Si, non-aging		75	260										
		≤ 12% Si, aged		90	310										
		> 12% Si, non-aging		130	450										
	Magnesium alloys				70	250									
	Copper and copper alloys	Unalloyed, electrolytic copper				100	340								
Brass, bronze, red brass				90	310										
Cu alloys, short-chipping				110	380										
High-tensile, Ampco alloy				300	1010										
S	Heat-resistant alloys	Fe-based	Annealed	200	680										
			Hardened	280	940										
		Ni or Co based	Annealed	250	840										
			Hardened	350	1180										
			Cast	320	1080										
	Titanium alloys	Pure titanium				200	680								
		α and β alloys, hardened				375	1260								
β alloys				410	1400										
Tungsten alloys				300	1010										
Molybdenum alloys				300	1010										
H	Hardened steel	Hardened and tempered		50HRC	-	40~45	0.020	0.030	0.040	0.050	0.050	0.060	0.070	0.090	
		Hardened and tempered		55HRC	-	35~40	0.020	0.030	0.041	0.045	0.050	0.055	0.070	0.090	
		Hardened and tempered		60HRC	-										
	Chilled cast iron		Hardened and tempered		50HRC	-	40~45	0.020	0.030	0.040	0.050	0.050	0.060	0.070	0.090

The cutting data are average recommended values. For special applications, adjustment is needed.

Solid Endmill

Solid Carbide End Mill XP Line Cutting Parameters

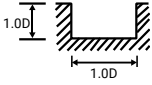
Materials					M121-4CSP M121-4CS M121-4ESP	Slot milling 								
ISO	Material classification		Brinell hardness (HB)	Tensile strength Rm(N/mm ²)	Cutting speed Vc(m/min)	fz [mm/Tooth]								
						Mill diameter [mm]								
						4	6	8	10	12	14	16	20	
P	Unalloyed steel	C≤0.25%	Annealed	125	428	152~168	0.008	0.016	0.027	0.038	0.047	0.049	0.053	0.065
		0.25 < C ≤ 0.55%	Annealed	190	639	152~166	0.008	0.016	0.027	0.038	0.047	0.049	0.053	0.065
		0.25 < C ≤ 0.55%	Heat-treated	210	708	152~166	0.008	0.016	0.027	0.038	0.047	0.049	0.053	0.065
		C > 0.55%	Annealed	190	639	157~166	0.008	0.016	0.027	0.038	0.047	0.049	0.053	0.065
		C > 0.55%	Heat-treated	300	1013	152~160	0.006	0.014	0.023	0.030	0.037	0.040	0.043	0.055
		Free cutting steel (short-chip)	Annealed	220	745	155~162	0.006	0.014	0.023	0.038	0.047	0.049	0.053	0.065
	Low-alloyed steel	Annealed		175	591	152~168	0.008	0.016	0.027	0.038	0.047	0.049	0.053	0.065
		Heat-treated		300	1013	107~117	0.007	0.015	0.023	0.032	0.040	0.041	0.043	0.056
		Heat-treated		380	1282	107~117	0.007	0.015	0.023	0.032	0.040	0.041	0.043	0.056
		Heat-treated		430	1477	87~107	0.005	0.013	0.019	0.027	0.035	0.036	0.038	0.050
	High-alloyed steel and high-alloyed tool steel	Annealed		200	675	64~70	0.006	0.011	0.019	0.027	0.032	0.034	0.037	0.045
		Hardened and tempered		300	1013	60~64	0.005	0.011	0.016	0.022	0.024	0.025	0.027	0.036
		Hardened and tempered		400	1361	60~64	0.004	0.007	0.013	0.017	0.019	0.020	0.022	0.030
	Stainless steel	Ferritic/martensitic, annealed		200	675	50~55	0.005	0.011	0.019	0.027	0.032	0.034	0.037	0.045
Martensitic, heat-treated		330	1114	45~50	0.005	0.011	0.016	0.022	0.024	0.025	0.027	0.036		
M	Stainless steel	Austenitic, quench hardened		200	675	106	0.008	0.018	0.028	0.048	0.055	0.059	0.062	0.077
		Austenitic, precipitation hardened (PH)		300	1013	95	0.008	0.018	0.028	0.048	0.055	0.059	0.062	0.077
		Austenitic/ferritic, duplex		230	778	106	0.008	0.018	0.028	0.048	0.055	0.059	0.062	0.077
K	Malleable cast iron	Ferritic		200	400	112~123	0.010	0.020	0.034	0.048	0.058	0.064	0.065	0.081
		Pearlitic		260	700	112~123	0.010	0.020	0.034	0.048	0.058	0.064	0.065	0.081
	Grey cast iron	Low tensile strength		180	200	112~123	0.010	0.020	0.034	0.048	0.058	0.064	0.065	0.081
		High tensile strength/austenitic		245	350	112~123	0.010	0.020	0.034	0.048	0.058	0.064	0.065	0.081
	Nodular cast iron	Ferritic		155	400	112~123	0.008	0.016	0.029	0.040	0.050	0.052	0.057	0.071
		Pearlitic		265	700	96~112	0.006	0.014	0.026	0.036	0.046	0.048	0.052	0.066
		GGV(CGI)		230	400	112~120	0.008	0.016	0.029	0.040	0.050	0.052	0.057	0.071
N	Wrought aluminium alloys	Non-aging		30	-									
		Aged		100	340									
	Cast aluminium alloys	≤ 12% Si, non-aging		75	260									
		≤ 12% Si, aged		90	310									
		> 12% Si, non-aging		130	450									
	Magnesium alloys			70	250									
	Copper and copper alloys	Unalloyed, electrolytic copper		100	340									
Brass, bronze, red brass		90	310											
Cu alloys, short-chipping		110	380											
High-tensile, Ampco alloy		300	1010											
S	Heat-resistant alloys	Fe-based	Annealed	200	680	26	0.007	0.012	0.019	0.033	0.038	0.040	0.043	0.054
			Hardened	280	940	24	0.007	0.012	0.017	0.029	0.033	0.034	0.037	0.046
		Ni or Co based	Annealed	250	840	24	0.007	0.012	0.017	0.029	0.033	0.034	0.037	0.046
			Hardened	350	1180	22	0.006	0.010	0.015	0.027	0.030	0.031	0.033	0.041
			Cast	320	1080	22	0.006	0.010	0.015	0.027	0.030	0.031	0.033	0.041
	Titanium alloys	Pure titanium		200	680	58	0.007	0.016	0.025	0.042	0.050	0.053	0.055	0.068
		α and β alloys, hardened		375	1260	45	0.006	0.014	0.021	0.035	0.040	0.044	0.050	0.060
		β alloys		410	1400	45	0.006	0.014	0.021	0.035	0.040	0.044	0.050	0.060
	Tungsten alloys			300	1010	22	0.006	0.010	0.015	0.027	0.030	0.031	0.033	0.041
	Molybdenum alloys			300	1010	22	0.006	0.010	0.015	0.027	0.030	0.031	0.033	0.041
H	Hardened steel	Hardened and tempered		50HRC	-									
		Hardened and tempered		55HRC	-									
		Hardened and tempered		60HRC	-									
	Chilled cast iron	Hardened and tempered		50HRC	-									

The cutting data are average recommended values. For special applications, adjustment is needed.

Solid Carbide End Mill XP Line Cutting Parameters

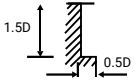
Materials					M121-4CSP M121-4CS M121-4ESP	Square shoulder milling 								
ISO	Material classification		Brinell hardness (HB)	Tensile strength Rm(N/mm²)	Cutting speed Vc(m/min)	fz [mm/Tooth]								
						Mill diameter [mm]								
						4	6	8	10	12	14	16	20	
P	Unalloyed steel	C≤0.25% Annealed	125	428	152~168	0.008	0.016	0.027	0.038	0.047	0.049	0.053	0.065	
		0.25 < C ≤ 0.55% Annealed	190	639	152~166	0.008	0.016	0.027	0.038	0.047	0.049	0.053	0.065	
		0.25 < C ≤ 0.55% Heat-treated	210	708	152~166	0.008	0.016	0.027	0.038	0.047	0.049	0.053	0.065	
		C > 0.55% Annealed	190	639	157~166	0.008	0.016	0.027	0.038	0.047	0.049	0.053	0.065	
		C > 0.55% Heat-treated	300	1013	152~160	0.006	0.014	0.023	0.030	0.037	0.040	0.043	0.055	
		Free cutting steel (short-chip) Annealed	220	745	155~162	0.006	0.014	0.023	0.038	0.047	0.049	0.053	0.065	
	Low-alloyed steel	Annealed	175	591	152~168	0.008	0.016	0.027	0.038	0.047	0.049	0.053	0.065	
		Heat-treated	300	1013	107~117	0.007	0.015	0.023	0.032	0.040	0.041	0.043	0.056	
		Heat-treated	380	1282	107~117	0.007	0.015	0.023	0.032	0.040	0.041	0.043	0.056	
		Heat-treated	430	1477	87~107	0.005	0.013	0.019	0.027	0.035	0.036	0.038	0.050	
	High-alloyed steel and high-alloyed tool steel	Annealed	200	675	64~70	0.006	0.011	0.019	0.027	0.032	0.034	0.037	0.045	
		Hardened and tempered	300	1013	60~64	0.005	0.011	0.016	0.022	0.024	0.025	0.027	0.036	
		Hardened and tempered	400	1361	60~64	0.004	0.007	0.013	0.017	0.019	0.020	0.022	0.030	
	Stainless steel	Ferritic/martensitic, annealed	200	675	50~55	0.005	0.011	0.019	0.027	0.032	0.034	0.037	0.045	
Martensitic, heat-treated		330	1114	45~50	0.005	0.011	0.016	0.022	0.024	0.025	0.027	0.036		
M	Stainless steel	Austenitic, quench hardened	200	675	106	0.008	0.018	0.028	0.048	0.055	0.059	0.062	0.077	
		Austenitic, precipitation hardened (PH)	300	1013	95	0.008	0.018	0.028	0.048	0.055	0.059	0.062	0.077	
		Austenitic/ferritic, duplex	230	778	106	0.008	0.018	0.028	0.048	0.055	0.059	0.062	0.077	
K	Malleable cast iron	Ferritic	200	400	112~123	0.010	0.020	0.034	0.048	0.058	0.064	0.065	0.081	
		Pearlitic	260	700	112~123	0.010	0.020	0.034	0.048	0.058	0.064	0.065	0.081	
	Grey cast iron	Low tensile strength	180	200	112~123	0.010	0.020	0.034	0.048	0.058	0.064	0.065	0.081	
		High tensile strength/austenitic	245	350	112~123	0.010	0.020	0.034	0.048	0.058	0.064	0.065	0.081	
	Nodular cast iron	Ferritic	155	400	112~123	0.008	0.016	0.029	0.040	0.050	0.052	0.057	0.071	
		Pearlitic	265	700	96~112	0.006	0.014	0.026	0.036	0.046	0.048	0.052	0.066	
		GGV(CGI)	230	400	112~120	0.008	0.016	0.029	0.040	0.050	0.052	0.057	0.071	
N	Wrought aluminium alloys	Non-aging	30	-										
		Aged	100	340										
	Cast aluminium alloys	≤ 12% Si, non-aging	75	260										
		≤ 12% Si, aged	90	310										
		> 12% Si, non-aging	130	450										
	Magnesium alloys		70	250										
	Copper and copper alloys	Unalloyed, electrolytic copper	100	340										
Brass, bronze, red brass		90	310											
Cu alloys, short-chipping		110	380											
High-tensile, Ampco alloy		300	1010											
S	Heat-resistant alloys	Fe-based	Annealed	200	680	26	0.007	0.012	0.019	0.033	0.038	0.040	0.043	0.054
			Hardened	280	940	24	0.007	0.012	0.017	0.029	0.033	0.034	0.036	0.045
		Ni or Co based	Annealed	250	840	24	0.007	0.012	0.017	0.029	0.033	0.034	0.036	0.045
			Hardened	350	1180	22	0.006	0.010	0.015	0.025	0.028	0.029	0.031	0.038
			Cast	320	1080	22	0.006	0.010	0.015	0.025	0.028	0.029	0.031	0.038
	Titanium alloys	Pure titanium	200	680	58	0.007	0.016	0.025	0.042	0.050	0.053	0.055	0.068	
		α and β alloys, hardened	375	1260	45	0.006	0.014	0.021	0.035	0.040	0.044	0.050	0.060	
		β alloys	410	1400	45	0.006	0.014	0.021	0.035	0.040	0.044	0.050	0.060	
	Tungsten alloys		300	1010	22	0.006	0.010	0.015	0.025	0.028	0.029	0.031	0.038	
	Molybdenum alloys		300	1010	22	0.006	0.010	0.015	0.025	0.028	0.029	0.031	0.038	
H	Hardened steel	Hardened and tempered	50HRC	-										
		Hardened and tempered	55HRC	-										
		Hardened and tempered	60HRC	-										
	Chilled cast iron	Hardened and tempered	50HRC	-										

The cutting data are average recommended values. For special applications, adjustment is needed.

Solid Carbide End Mill XP Line Cutting Parameters

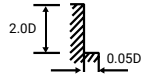
Materials				M125-6ES Square shoulder milling (Finishing) 								
ISO	Material classification		Brinell hardness (HB)	Tensile strength Rm(N/mm ²)	Cutting speed Vc(m/min)	fz [mm/Tooth]						
						Mill diameter [mm]						
						4	8	10	12	16	20	
P	Unalloyed steel	C≤0.25% Annealed	125	428	300	0.068	0.116	0.144	0.173	0.202	0.225	
		0.25 < C ≤ 0.55% Annealed	190	639	280	0.068	0.116	0.144	0.173	0.202	0.225	
		0.25 < C ≤ 0.55% Heat-treated	210	708	280	0.068	0.116	0.144	0.173	0.202	0.225	
		C > 0.55% Annealed	190	639	280	0.068	0.116	0.144	0.173	0.202	0.225	
		C > 0.55% Heat-treated	300	1013	260	0.065	0.110	0.136	0.164	0.161	0.211	
		Free cutting steel (short-chip) Annealed	220	745	280	0.068	0.116	0.144	0.173	0.202	0.225	
	Low-alloyed steel	Annealed	175	591	300	0.068	0.116	0.144	0.173	0.202	0.225	
		Heat-treated	300	1013	240	0.058	0.100	0.125	0.150	0.175	0.196	
		Heat-treated	380	1282	240	0.058	0.100	0.125	0.150	0.175	0.196	
		Heat-treated	430	1477	203	0.050	0.085	0.106	0.128	0.149	0.167	
	High-alloyed steel and high-alloyed tool steel	Annealed	200	675	100	0.041	0.071	0.088	0.105	0.123	0.137	
		Hardened and tempered	300	1013	82	0.041	0.071	0.088	0.105	0.123	0.137	
		Hardened and tempered	400	1361	70	0.033	0.061	0.076	0.092	0.119	0.121	
	Stainless steel	Ferritic/martensitic, annealed	200	675	100	0.041	0.071	0.088	0.105	0.123	0.137	
Martensitic, heat-treated		330	1114	82	0.041	0.067	0.082	0.095	0.111	0.119		
M	Stainless steel	Austenitic, quench hardened	200	675	213	0.049	0.084	0.101	0.125	0.146	0.162	
		Austenitic, precipitation hardened (PH)	300	1013	170	0.037	0.070	0.096	0.110	0.130	0.145	
		Austenitic/ferritic, duplex	230	778	213	0.049	0.084	0.101	0.125	0.146	0.162	
K	Malleable cast iron	Ferritic	200	400	225	0.082	0.139	0.173	0.208	0.242	0.270	
		Pearlitic	260	700	225	0.082	0.139	0.173	0.208	0.242	0.270	
	Grey cast iron	Low tensile strength	180	200	225	0.082	0.139	0.173	0.208	0.242	0.270	
		High tensile strength/austenitic	245	350	225	0.082	0.139	0.173	0.208	0.242	0.270	
	Nodular cast iron	Ferritic	155	400	75~85	0.075	0.130	0.163	0.196	0.228	0.253	
		Pearlitic	265	700	200	0.074	0.128	0.160	0.192	0.223	0.247	
GGV(CGI)		230	400	75~85	0.075	0.130	0.163	0.196	0.228	0.253		
N	Wrought aluminium alloys	Non-aging	30	-								
		Aged	100	340								
	Cast aluminium alloys	≤ 12% Si, non-aging	75	260								
		≤ 12% Si, aged	90	310								
		> 12% Si, non-aging	130	450								
	Magnesium alloys		70	250								
	Copper and copper alloys	Unalloyed, electrolytic copper	100	340								
Brass, bronze, red brass		90	310									
Cu alloys, short-chipping		110	380									
High-tensile, Ampco alloy		300	1010									
S	Heat-resistant alloys	Fe-based	Annealed	200	680	33	0.033	0.055	0.070	0.082	0.097	0.112
			Hardened	280	940	30	0.031	0.052	0.064	0.074	0.087	0.100
		Ni or Co based	Annealed	250	840	30	0.031	0.052	0.064	0.074	0.087	0.100
			Hardened	350	1180	27	0.031	0.050	0.061	0.070	0.082	0.091
			Cast	320	1080	27	0.031	0.050	0.061	0.070	0.082	0.091
	Titanium alloys	Pure titanium	200	680	116	0.033	0.055	0.070	0.083	0.097	0.113	
		α and β alloys, hardened	375	1260	95	0.031	0.051	0.065	0.074	0.087	0.100	
		β alloys	410	1400	95	0.031	0.051	0.065	0.074	0.087	0.100	
	Tungsten alloys		300	1010	27	0.031	0.050	0.061	0.070	0.082	0.091	
	Molybdenum alloys		300	1010	27	0.031	0.050	0.061	0.070	0.082	0.091	
H	Hardened steel	Hardened and tempered	50HRC	-								
		Hardened and tempered	55HRC	-								
		Hardened and tempered	60HRC	-								
	Chilled cast iron	Hardened and tempered	50HRC	-								

The cutting data are average recommended values. For special applications, adjustment is needed.

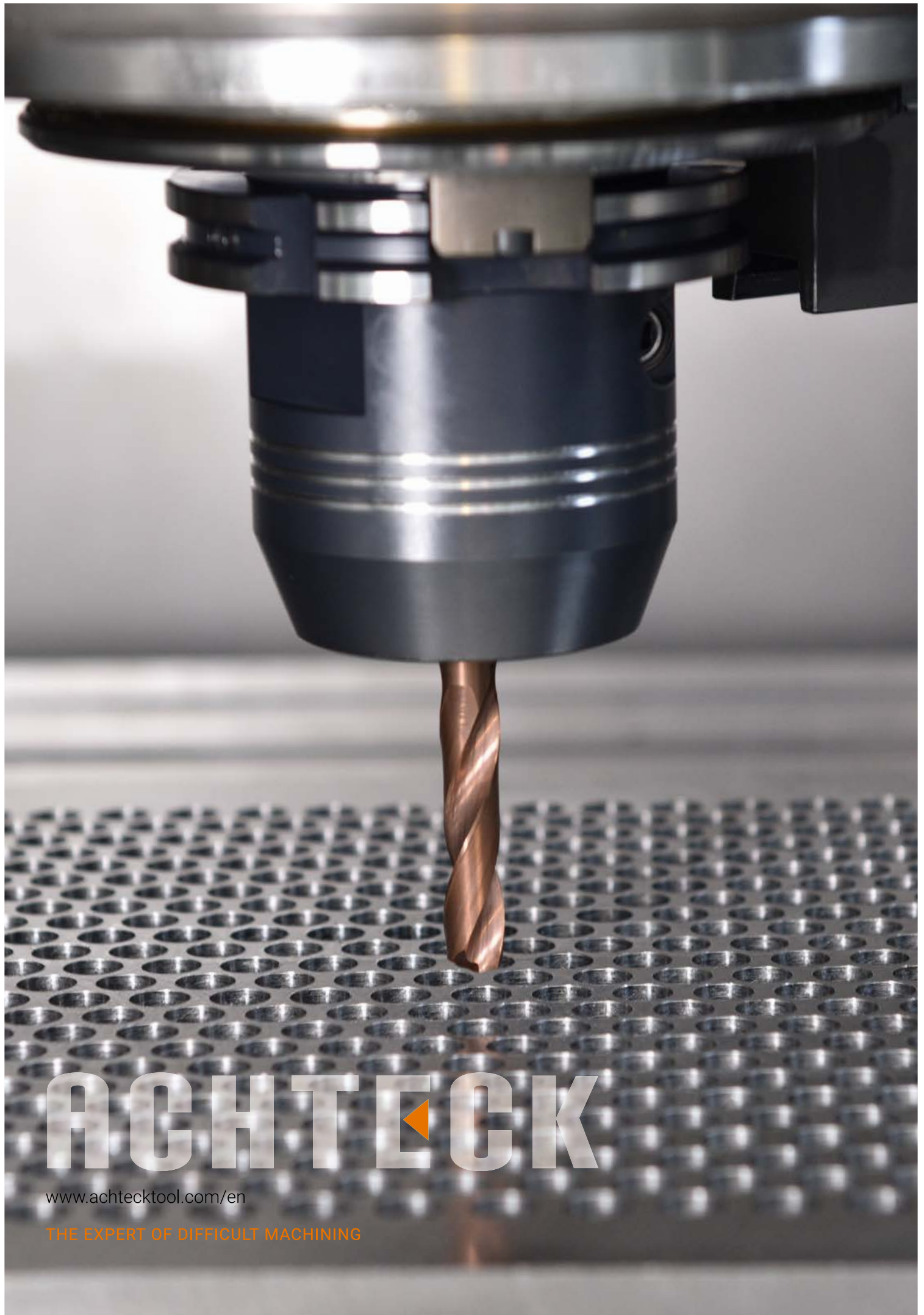

ACHTTECK

www.achtecktool.com/en

THE EXPERT OF DIFFICULT MACHINING

CUTTING TOOL CATALOGUE

Drilling Holder	342	Solid Carbide Drill	397
Drilling Holder Denomination System	345	Denomination System	398
HP Series Drilling Holder	346	Product Overview	398
		D106-03A0...Product List	399
Drilling Insert	352	D106-05A0...Product List	403
Drilling Insert Denomination System	352	D106-03A1...Product List	407
Drilling Grade Application Guide	354	D106-05A1...Product List	411
Drilling Insert	356	D108-08A1...Product List	415
Drilling Parameter Recommendation	357	Cutting Parameters	418
Deep-Hole Drilling Product Introduction	359	Feed Reference Table	419
Deep-Hole Drilling Inserts	361	Thread Pilot Hole Diameters-Tapping	420
Drilling Parameter Recommendation	365	Thread Pilot Hole Diameters- Forming	421
Boring Tool	368		
Over View of Boring Tool	369		
ARB Rough Boring Series	370		
MLR Series Large Diameter Boring Tool	373		
AFB Fine Boring Series	374		
MLF Series Large Diameter Fine Boring Tool	376		
DFB Anti-vibration Fine Boring Series	378		
SFB Series Small Diameter Fine Boring Tools	379		
EFB External Fine Boring Series	380		
BT Modular Adaptor	381		
BT Modular Reinforced Adaptor	382		
HSK-A Modular Adaptor	382		
BT50 Bridge Boring Adaptor	383		
HSK-A100 Bridge Boring Adaptor	383		
Extention Bar/ Reduction Bar	384		
ISO Cartridge	385		
Fine Adjustment Cartridge	390		
Boring Insert	395		
Boring Operator's Manual	396		

ACHTTECK

www.achtecktool.com/en

THE EXPERT OF DIFFICULT MACHINING



Drilling Holder

Drilling Holder Denomination System

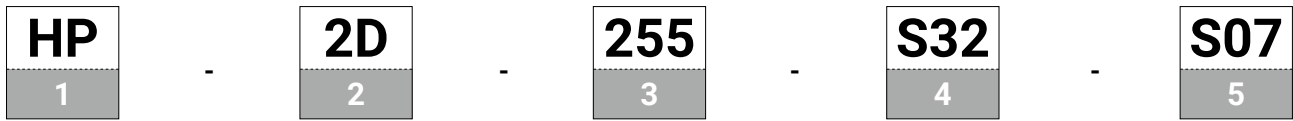



1	HP	Product series	HP: High productivity drilling body series			
2	2D	Length-diameter ratio	2D, 3D, 4D,			
3	255	Tool diameter	255-25.5mm, 500-50mm			
4	S32	Shank diameter	S20=20mm	S25=25mm	S32=32mm	S40=40mm
5	S07	Insert shape and edge length	The insert shape is "S", the cutting edge length is 7mm			

HP Series Drilling Holder

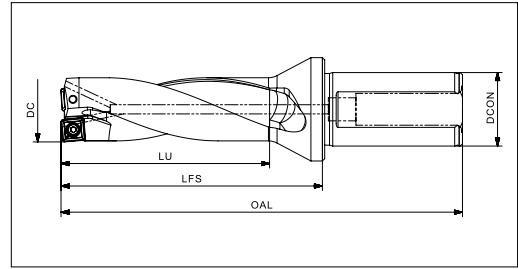
Length-diameter ratio: 2D

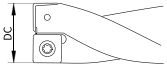

Product code	Dimension (mm)					Inserts
	DC	LU	OAL	DCON	LFS	
HP-2D130-S20-S05	13.0	29	99	20	49	SPMT 050204E-DP
HP-2D135-S20-S05	13.5	30	100	20	50	
HP-2D140-S20-S05	14.0	31	101	20	51	
HP-2D145-S20-S05	14.5	32	102	20	52	
HP-2D150-S20-S05	15.0	33	103	20	53	
HP-2D155-S25-S06	15.5	34	115	25	59	SPMT 060204E-DP
HP-2D160-S25-S06	16.0	35	116	25	60	
HP-2D165-S25-S06	16.5	36	117	25	61	
HP-2D170-S25-S06	17.0	37	118	25	62	
HP-2D175-S25-S06	17.5	38	119	25	63	
HP-2D180-S25-S06	18.0	39	120	25	64	
HP-2D185-S25-S06	18.5	40	121	25	65	
HP-2D190-S25-S06	19.0	41	122	25	66	
HP-2D195-S25-S06	19.5	42	123	25	67	
HP-2D200-S25-S06	20.0	43	124	25	68	
HP-2D205-S25-S06	20.5	44	125	25	69	
HP-2D210-S25-S06	21.0	45	126	25	70	
HP-2D215-S25-S06	21.5	46	127	25	71	
HP-2D220-S32-S07	22.0	47	137	32	77	SPMT 07T308E-DP
HP-2D225-S32-S07	22.5	48	138	32	78	
HP-2D230-S32-S07	23.0	49	139	32	79	
HP-2D235-S32-S07	23.5	50	140	32	80	
HP-2D240-S32-S07	24.0	51	141	32	81	
HP-2D245-S32-S07	24.5	52	142	32	82	
HP-2D250-S32-S07	25.0	53	143	32	83	
HP-2D255-S32-S07	25.5	54	144	32	84	
HP-2D260-S32-S07	26.0	55	145	32	85	
HP-2D265-S32-S07	26.5	56	146	32	86	
HP-2D270-S32-S07	27.0	57	147	32	87	
HP-2D275-S32-S07	27.5	58	148	32	88	



Dimension (mm)	Spare parts	
Holder diameter	Screw	Wrench
		
13-15	ST020043	FT-T06
15.5-21.5	ST022055	FT-T06
22-27.5	ST025065	FT-T08

HP Series Drilling Holder

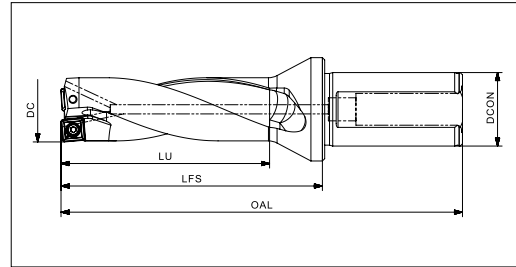
Length-diameter ratio: 2D

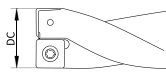

Product code	Dimension (mm)					Inserts
	DC	LU	OAL	DCON	LFS	
HP-2D280-S32-S09	28.0	59	149	32	89	SPMT 090408E-DP
HP-2D285-S32-S09	28.5	60	150	32	90	
HP-2D290-S32-S09	29.0	61	151	32	91	
HP-2D295-S32-S09	29.5	63	153	32	93	
HP-2D300-S32-S09	30.0	65	155	32	95	
HP-2D310-S32-S09	31.0	67	157	32	97	
HP-2D320-S32-S09	32.0	69	159	32	99	
HP-2D330-S32-S09	33.0	71	161	32	101	
HP-2D340-S40-S11	34.0	73	178	40	108	SPMT 110408E-DP
HP-2D350-S40-S11	35.0	75	180	40	110	
HP-2D360-S40-S11	36.0	77	182	40	112	
HP-2D370-S40-S11	37.0	79	184	40	114	
HP-2D380-S40-S11	38.0	81	186	40	116	
HP-2D390-S40-S11	39.0	83	188	40	118	
HP-2D400-S40-S11	40.0	85	190	40	120	
HP-2D410-S40-S11	41.0	87	192	40	122	
HP-2D420-S40-S14	42.0	89	194	40	124	SPMT 140512E-DP
HP-2D430-S40-S14	43.0	91	196	40	126	
HP-2D440-S40-S14	44.0	93	198	40	128	
HP-2D450-S40-S14	45.0	95	200	40	130	
HP-2D460-S40-S14	46.0	97	202	40	132	
HP-2D470-S40-S14	47.0	99	204	40	134	
HP-2D480-S40-S14	48.0	101	206	40	136	
HP-2D490-S40-S14	49.0	103	208	40	138	
HP-2D500-S40-S14	50.0	105	210	40	140	

Dimension (mm)	Spare parts	
Holder diameter	Screw	Wrench
 28-33	 ST035084X	 FT-T15
34-41	ST040100H	FT-T15
42-50	ST050126	FT-T20



Drilling holder

HP Series Drilling Holder

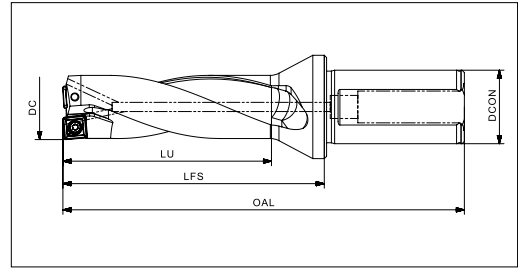
Length-diameter ratio: 3D

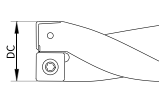

Product code	Dimension (mm)					Inserts
	DC	LU	OAL	DCON	LFS	
HP-3D130-S20-S05	13.0	42	112	20	62	SPMT 050204E-DP
HP-3D135-S20-S05	13.5	44	114	20	64	
HP-3D140-S20-S05	14.0	45	115	20	65	
HP-3D145-S20-S05	14.5	47	117	20	67	
HP-3D150-S20-S05	15.0	48	118	20	68	
HP-3D155-S25-S06	15.5	50	131	25	75	SPMT 060204E-DP
HP-3D160-S25-S06	16.0	51	132	25	76	
HP-3D165-S25-S06	16.5	53	134	25	78	
HP-3D170-S25-S06	17.0	54	135	25	79	
HP-3D175-S25-S06	17.5	56	137	25	81	
HP-3D180-S25-S06	18.0	57	138	25	82	
HP-3D185-S25-S06	18.5	59	140	25	84	
HP-3D190-S25-S06	19.0	60	141	25	85	
HP-3D195-S25-S06	19.5	62	143	25	87	
HP-3D200-S25-S06	20.0	63	144	25	88	
HP-3D205-S25-S06	20.5	65	146	25	90	
HP-3D210-S25-S06	21.0	66	147	25	91	
HP-3D215-S25-S06	21.5	68	149	25	93	
HP-3D220-S32-S07	22.0	69	159	32	99	SPMT 07T308E-DP
HP-3D225-S32-S07	22.5	71	161	32	101	
HP-3D230-S32-S07	23.0	72	162	32	102	
HP-3D235-S32-S07	23.5	74	164	32	104	
HP-3D240-S32-S07	24.0	75	165	32	105	
HP-3D245-S32-S07	24.5	77	167	32	107	
HP-3D250-S32-S07	25.0	78	168	32	108	
HP-3D255-S32-S07	25.5	80	170	32	110	
HP-3D260-S32-S07	26.0	81	171	32	111	
HP-3D265-S32-S07	26.5	83	173	32	113	
HP-3D270-S32-S07	27.0	84	174	32	114	
HP-3D275-S32-S07	27.5	86	176	32	116	

Dimension (mm)	Spare parts	
Holder diameter	Screw	Wrench
		
13-15	ST020043	FT-T06
15.5-21.5	ST022055	FT-T06
22-27.5	ST025065	FT-T08

HP Series Drilling Holder

Length-diameter ratio: 3D

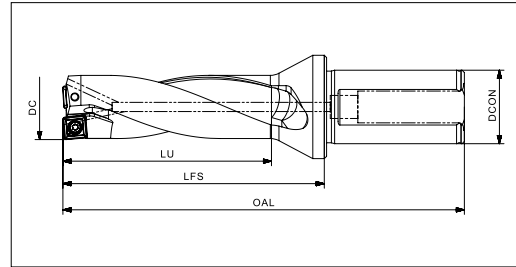

Product code	Dimension (mm)					Inserts
	DC	LU	OAL	DCON	LFS	
HP-3D280-S32-S09	28.0	87	177	32	117	SPMT 090408E-DP
HP-3D285-S32-S09	28.5	89	179	32	119	
HP-3D290-S32-S09	29.0	90	180	32	120	
HP-3D295-S32-S09	29.5	93	183	32	123	
HP-3D300-S32-S09	30.0	95	185	32	125	
HP-3D310-S32-S09	31.0	98	188	32	128	
HP-3D320-S32-S09	32.0	101	191	32	131	
HP-3D330-S32-S09	33.0	104	194	32	134	
HP-3D340-S40-S11	34.0	107	212	40	142	SPMT 110408E-DP
HP-3D350-S40-S11	35.0	110	215	40	145	
HP-3D360-S40-S11	36.0	113	218	40	148	
HP-3D370-S40-S11	37.0	116	221	40	151	
HP-3D380-S40-S11	38.0	119	224	40	154	
HP-3D390-S40-S11	39.0	122	227	40	157	
HP-3D400-S40-S11	40.0	125	230	40	160	
HP-3D410-S40-S11	41.0	128	233	40	163	
HP-3D420-S40-S14	42.0	131	236	40	166	SPMT 140512E-DP
HP-3D430-S40-S14	43.0	134	239	40	169	
HP-3D440-S40-S14	44.0	137	242	40	172	
HP-3D450-S40-S14	45.0	140	245	40	175	
HP-3D460-S40-S14	46.0	143	248	40	178	
HP-3D470-S40-S14	47.0	146	251	40	181	
HP-3D480-S40-S14	48.0	149	254	40	184	
HP-3D490-S40-S14	49.0	152	257	40	187	
HP-3D500-S40-S14	50.0	155	260	40	190	

Dimension (mm)	Spare parts	
Holder diameter	Screw	Wrench
28-33	ST035084X	FT-T15
34-41	ST040100H	FT-T15
42-50	ST050126	FT-T20



Drilling holder

HP Series Drilling Holder

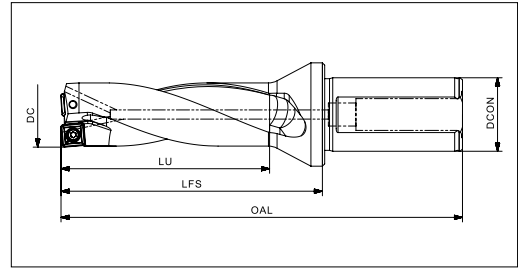
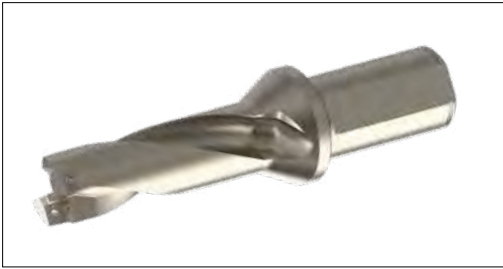
Length-diameter ratio: 4D

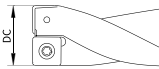

Product code	Dimension (mm)					Inserts
	DC	LU	OAL	DCON	LFS	
HP-4D130-S20-S05	13.0	55	125	20	75	SPMT 050204E-DP
HP-4D135-S20-S05	13.5	57	127	20	77	
HP-4D140-S20-S05	14.0	59	129	20	79	
HP-4D145-S20-S05	14.5	61	131	20	81	
HP-4D150-S20-S05	15.0	63	133	20	83	
HP-4D155-S25-S06	15.5	65	146	25	90	SPMT 060204E-DP
HP-4D160-S25-S06	16.0	67	148	25	92	
HP-4D165-S25-S06	16.5	69	150	25	94	
HP-4D170-S25-S06	17.0	71	152	25	96	
HP-4D175-S25-S06	17.5	73	154	25	98	
HP-4D180-S25-S06	18.0	75	156	25	100	
HP-4D185-S25-S06	18.5	77	158	25	102	
HP-4D190-S25-S06	19.0	79	160	25	104	
HP-4D195-S25-S06	19.5	81	162	25	106	
HP-4D200-S25-S06	20.0	83	164	25	108	
HP-4D205-S25-S06	20.5	85	166	25	110	
HP-4D210-S25-S06	21.0	87	168	25	112	
HP-4D215-S25-S06	21.5	89	170	25	114	
HP-4D220-S32-S07	22.0	91	181	32	121	SPMT 07T308E-DP
HP-4D225-S32-S07	22.5	93	183	32	123	
HP-4D230-S32-S07	23.0	95	185	32	125	
HP-4D235-S32-S07	23.5	97	187	32	127	
HP-4D240-S32-S07	24.0	99	189	32	129	
HP-4D245-S32-S07	24.5	101	191	32	131	
HP-4D250-S32-S07	25.0	103	193	32	133	
HP-4D255-S32-S07	25.5	105	195	32	135	
HP-4D260-S32-S07	26.0	107	197	32	137	
HP-4D265-S32-S07	26.5	109	199	32	139	
HP-4D270-S32-S07	27.0	111	201	32	141	
HP-4D275-S32-S07	27.5	113	203	32	143	

Dimension (mm)	Spare parts	
Holder diameter	Screw	Wrench
		
13-15	ST020043	FT-T06
15.5-21.5	ST022055	FT-T06
22-27.5	ST025065	FT-T08

HP Series Drilling Holder

Length-diameter ratio: 4D

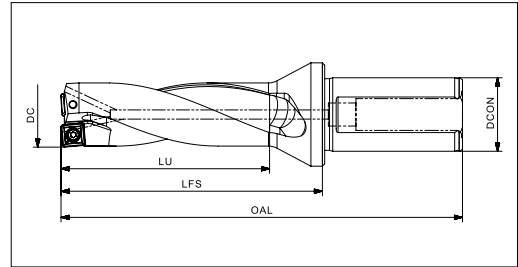

Product code	Dimension (mm)					Inserts
	DC	LU	OAL	DCON	LFS	
HP-4D280-S32-S09	28.0	115	205	32	145	SPMT 090408E-DP
HP-4D285-S32-S09	28.5	117	207	32	147	
HP-4D290-S32-S09	29.0	120	210	32	150	
HP-4D295-S32-S09	29.5	123	213	32	153	
HP-4D300-S32-S09	30.0	125	215	32	155	
HP-4D310-S32-S09	31.0	129	219	32	159	
HP-4D320-S32-S09	32.0	133	223	32	163	
HP-4D330-S32-S09	33.0	137	227	32	167	
HP-4D340-S40-S11	34.0	141	246	40	176	SPMT 110408E-DP
HP-4D350-S40-S11	35.0	145	250	40	180	
HP-4D360-S40-S11	36.0	149	254	40	184	
HP-4D370-S40-S11	37.0	153	258	40	188	
HP-4D380-S40-S11	38.0	157	262	40	192	
HP-4D390-S40-S11	39.0	161	266	40	196	
HP-4D400-S40-S11	40.0	165	270	40	200	
HP-4D410-S40-S11	41.0	169	274	40	204	
HP-4D420-S40-S14	42.0	173	278	40	208	SPMT 140512E-DP
HP-4D430-S40-S14	43.0	177	282	40	212	
HP-4D440-S40-S14	44.0	181	286	40	216	
HP-4D450-S40-S14	45.0	185	290	40	220	
HP-4D460-S40-S14	46.0	189	294	40	224	
HP-4D470-S40-S14	47.0	193	298	40	228	
HP-4D480-S40-S14	48.0	197	302	40	232	
HP-4D490-S40-S14	49.0	201	306	40	236	
HP-4D500-S40-S14	50.0	205	310	40	240	

Dimension (mm)	Spare parts	
Holder diameter	Screw	Wrench
28-33	ST035084X	FT-T15
34-41	ST040100H	FT-T15
42-50	ST050126	FT-T20

Drilling holder

Drilling Insert Denomination System

S
1

P
2

M
3

T
4

1- Shape/Code









S



W



2- Clearance Angle

A	B	C	D	E
				
F	G	N	P	O
				Other clearance angle

3- Tolerance

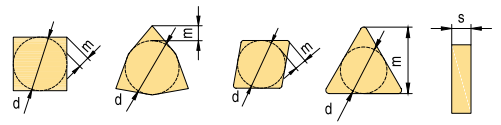















Class	Unit	In. Circle dimension d	Nose height m	Thickness s
A	mm	± 0,025	± 0,005	± 0,025
C	mm	± 0,025	± 0,013	± 0,025
E	mm	± 0,025	± 0,025	± 0,025
F	mm	± 0,013	± 0,005	± 0,025
G	mm	± 0,025	± 0,025	± 0,13
H	mm	± 0,013	± 0,013	± 0,025
J	mm	*	± 0,005	± 0,025
K	mm	*	± 0,013	± 0,025
L	mm	*	± 0,025	± 0,025
M	mm	*	*	± 0,127
U	mm	*	*	± 0,127
N	mm	*	*	± 0,025

* For details refer to right and below tables

IC	Shape: C, E, H, M, O, P, S, T, R, W			
	d		m	
	J,K,L,M,N	U	M, N	U
4.76	± 0,05	± 0,08	± 0,08	± 0,13
5.56	± 0,05	± 0,08	± 0,08	± 0,13
6	± 0,05	± 0,08	± 0,08	± 0,13
6.35	± 0,05	± 0,08	± 0,08	± 0,13
7.94	± 0,05	± 0,08	± 0,08	± 0,13
8	± 0,05	± 0,08	± 0,08	± 0,13
9.525	± 0,05	± 0,08	± 0,08	± 0,13
10	± 0,05	± 0,08	± 0,08	± 0,13
12	± 0,08	± 0,13	± 0,13	± 0,2
12.7	± 0,08	± 0,13	± 0,13	± 0,2
15.875	± 0,1	± 0,18	± 0,15	± 0,27
16	± 0,1	± 0,18	± 0,15	± 0,27
19.05	± 0,1	± 0,18	± 0,15	± 0,27
20	± 0,1	± 0,18	± 0,15	± 0,27
25	± 0,13	± 0,25	± 0,18	± 0,38
25.4	± 0,13	± 0,25	± 0,18	± 0,38
31.75	± 0,15	± 0,25	± 0,2	± 0,38
32	± 0,15	± 0,25	± 0,2	± 0,38

M&N shape	D shape		V shape	
	d	m	d	m
5.56	± 0,05	± 0,11		
6.35	± 0,05	± 0,11	± 0,05	± 0,16
7.94	± 0,05	± 0,11	± 0,05	± 0,16
9.525	± 0,05	± 0,11	± 0,05	± 0,16
12.7	± 0,08	± 0,15	± 0,08	± 0,2
15.875	± 0,10	± 0,18	± 0,10	± 0,27
19.05	± 0,10	± 0,18	± 0,10	± 0,27

4- Clamping Type

A	B	C	F	G
				
H	J	M	N	Q
				
R	T	U	W	Z
				Special

06	02	04	E	-	DP
5	6	7	8	-	9



5- Cutting Edge Length				
In.Circle Dimension (mm)	S Code	S Length	W Code	W Length
5.56			03	3.8
6.35	06	6.35	04	4.3
7.94			05	5.4
8.0	08	8.0		
9.525	09	9.525	06	6.5
12.7	12	12.7	08	8.7

7- Corner Radius		
Example		
04	=	0.4
08	=	0.8
12	=	1.2

8- Cutting Edge Shape	
Example	Description
E	Honed cutting edge
F	Sharp cutting edge
T	Negative land

6- Insert Thickness		
Thickness description	Thickness mark	Example
		00 = 0.79
		T0 = 0.99
		01 = 1.59
		T1 = 1.98
		02 = 2.38
		T2 = 2.58
		03 = 3.18
		T3 = 3.97
		04 = 4.76
		T4 = 4.96
		05 = 5.56
		T5 = 5.95
		06 = 6.35
		07 = 7.94
		09 = 9.53
		11 = 11.11
		12 = 12.70
		14 = 14.29
		15 = 15.88

Insert thickness "S" refers to the distance between cutting edge nose and bottom

9- Geometry Code	
<p>DP</p> <ol style="list-style-type: none"> DP geometry has high efficiency. Suitable for short hole high speed drilling. Strong square insert with reinforced geometry offers excellent hole straightness. Drilling holder with helical flute provides excellent chip evacuation and high hole precision. 	
<p>DU/DG</p> <ol style="list-style-type: none"> Suitable cutting angle makes perfect balance for the cutting force. General purpose geometry combined with two grades are suitable for P, M, K, S materials, especially good for the chip control in soft materials. Obtains good surface finish. Good versatility. It's suitable for rotating and non-rotating machining. 	

Drilling holder

Drilling Grade Application Guide

Drilling insert grade ISO group													
Material Group	Materials	ISO	Coated										Uncoated
			PVD	PVD	PVD	PVD	PVD	PVD	PVD	PVD	CVD	CVD	
P	Unalloy steels / Alloyed steels	P01											
		P05											
		P10											
		P15											
		P20	AP301U										
		P25		AP351M									
		P30			AP351U								
		P35											
		P40											
		P45											
		P50											
M	Stainless steels	M01											
		M05											
		M10											
		M15											
		M20											
		M25	AP351M										
		M30		AP351U									
		M35											
		M40											
		M45											
K	Cast iron	K01											
		K05											
		K10											
		K15											
		K20											
		K25											
		K30											
		K35											
		K40											
		K45											
K50													
N	Aluminum/ Aluminum alloys	N01											
		N05											
		N10											
		N15											
		N20											
		N25											
		N30											
S	Heat resistant alloys	S01											
		S05											
		S10											
		S15											
		S20											
		S25	AP351M										
		S30		AP351U									
		S35											
		S40											
		S45											

Drilling Grade Description

P

Steel, cast steel, ferritic / martensitic stainless steel, malleable cast iron

Basic grade

AP301U(P15-P35)

Recommended grade for steel drilling.

High strength and wear resistance ultra fine carbide substrate with nanostructured PVD coating in controllable layers, high coating adhesion, wear-resistance and strength.

AP351M(P25-P40)

Recommended grade for drilling steel parts under unstable working conditions.

Good toughness and wear resistance ultrafine crystalline substrate combined with nanostructure PVD coating.
Good thermal cracking resistance, wear resistance and coating strength.

AP351U(P30-P45)

Recommended grade for drilling steel parts under complex working conditions. Very tough substrate with nanostructured PVD coating.
Good wear resistance and impact resistance.

M

Austenitic stainless steel, cast steel, manganese steel, alloyed cast iron, malleable cast iron, easy to cut steel

Basic grade

AP351M(M25-M40)

Recommended grade for stainless steel drilling.

Very tough and good wear resistance ultrafine crystalline substrate with nanostructured PVD coating.
Good thermal cracking resistance, wear resistance and coating strength.

S

Heat resistant alloy

Basic grade

AP351M(S25-S40)

Recommended grade for heat resistant alloy drilling.

Good toughness and wear resistance ultrafine crystalline substrate combined with nanostructure PVD coating,
good resistance to thermal cracking resistance, wear resistance and coating strength.

AP351U(S30-S45)

Recommended grade for heat resistant alloy drilling under unstable working conditions and low speed.

Very tough substrate with nanostructured PVD coating, good wear resistance and impact resistance.

SPMT-DP Drilling Insert

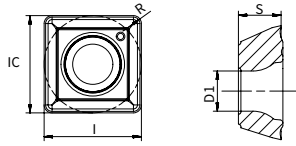

Inserts	Product code	Dimensions					Machining conditions					
		I	IC	S	R	D1	● Good condition ✦ Bad condition			✦ General condition		
							P	M	K	N		
							AP301U	AP351U	AC301P	AP351M	AP301U	AW100K
	SPMT 050204E-DP	5	5	2.38	0.4	2.25	●	●	●	●	●	
	SPMT 060204E-DP	6	6	2.38	0.4	2.61	●	●	●	●	●	
	SPMT 07T308E-DP	7.94	7.94	3.97	0.8	2.85	●	●	●	●	●	
	SPMT 090408E-DP	9.8	9.8	4.3	0.8	4.05	●	●	●	●	●	
	SPMT 110408E-DP	11.5	11.5	4.8	0.8	4.45	●	●	●	●	●	
	SPMT 140512E-DP	14.3	14.3	5.2	1.2	5.75	●	●	●	●	●	

● Stocked ○ Unstocked ▲ Stopped in the near future

WCMT-DU Drilling Insert

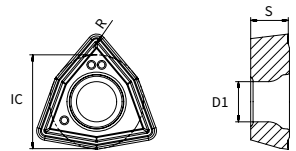

Inserts	Product code	Dimensions					Machining conditions					
		I	IC	S	R	D1	● Good condition ✦ Bad condition			✦ General condition		
							P	M	K	N		
							AP301U	AP351U	AC301P	AP351M	AP301U	AW100K
	WCMT 030208E-DU	3.8	5.56	2.38	0.8	2.8	●	●				
	WCMT 040208E-DU	4.3	6.35	2.38	0.8	3.0	●	●				
	WCMT 050308E-DU	5.4	7.94	3.18	0.8	3.4	●	●				
	WCMT 06T308E-DU	6.5	9.53	3.97	0.8	3.9	●	●				
	WCMT 080412E-DU	8.7	12.7	4.76	1.2	4.4	●	●				

Remark: DU series are universal inserts, no toolholder is provided.

● Stocked ○ Unstocked ▲ Stopped in the near future

WCMT-DG Drilling Insert

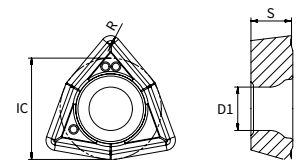

Inserts	Product code	Dimensions					Machining conditions					
		I	IC	S	R	D1	● Good condition ✦ Bad condition			✦ General condition		
							P	M	K	N		
							AP301U	AP351U	AC301P	AP351M	AP301U	AW100K
	WCMT 030204E-DG	3.8	5.56	2.38	0.4	2.5	▲	▲				
	WCMT 040204E-DG	4.3	6.35	2.38	0.4	2.8	▲	▲				
	WCMT 050308E-DG	5.4	7.94	3.18	0.8	3.4	▲	▲				
	WCMT 06T308E-DG	6.5	9.53	3.97	0.8	4.45	▲	▲				
	WCMT 080408E-DG	8.7	12.7	4.76	0.8	5.5	▲	▲				

● Stocked ○ Unstocked ▲ Stopped in the near future

Cutting Parameter Recommendation

Materials		SP drilling insert series grade application range & cutting parameter recommendation																		
		Grade				Feed (mm/rev)														
ISO	Material classification	Tensile strength (N/mm ²)	Hardness (HB)	Cutting speed (m/min)										Feed (mm/rev)						
				Max	Med	Min	Max	Med	Min	Max	Med	Min	Max	Med	Min	Max	Med	Min		
P	Unalloyed steel	<600	<180	240	224	220	185	150	240	220	200	175	150	0.05-0.08	0.06-0.10	0.06-0.12	0.07-0.13	0.08-0.15	0.08-0.16	
		<950	<280	250	210	200	170	140	230	190	160	162.5	135	0.06-0.12	0.08-0.15	0.10-0.18	0.12-0.22	0.12-0.24	0.13-0.25	
	Alloyed steel	700-950	200-280	240	200	160	190	160	130	220	180	150	120	0.06-0.10	0.08-0.14	0.10-0.18	0.12-0.22	0.12-0.23	0.13-0.24	
		950-1200	280-355	210	170	130	170	130	90	190	150	110	100	0.06-0.12	0.08-0.15	0.10-0.18	0.12-0.22	0.12-0.24	0.13-0.25	
	Duplex stainless steel	1200-1400	355-415	170	140	110	160	120	80	150	120	90	110	80	0.06-0.10	0.08-0.14	0.10-0.18	0.12-0.22	0.12-0.23	
		778	230	260	200	140	180	135	90	240	180	120	-	0.05-0.10	0.06-0.12	0.08-0.15	0.09-0.16	0.10-0.17	0.11-0.18	
	Austenitic stainless steel	675	200	220	170	120	120	65	60	200	150	100	-	0.05-0.10	0.06-0.12	0.08-0.15	0.09-0.16	0.10-0.17	0.11-0.18	
		1013	300	180	140	100	90	65	40	160	120	80	-	-	-	-	-	-	-	
	K	Grey cast iron	700	220	-	-	-	-	-	-	-	-	-	-	-	-	-	-	-	-
		Nodular cast iron	880	260	-	-	-	-	-	-	-	-	-	-	-	-	-	-	-	-
Malleable cast iron		800	250	-	-	-	-	-	-	-	-	-	-	-	-	-	-	-	-	
N	Aluminum	260	75	-	-	-	-	-	-	-	-	-	-	-	-	-	-	-	-	
	Aluminum alloy	447	130	-	-	-	-	-	-	-	-	-	-	-	-	-	-	-	-	
S	Fe-based alloy	943	280	-	-	40	30	20	45	35	25	-	-	-	-	-	-	-	-	
	Co-based alloy	1076	320	-	-	35	25	15	40	30	20	-	-	-	-	-	-	-	-	
	Ni-based alloy	1177	350	-	-	35	25	15	40	30	20	-	-	-	-	-	-	-	-	
	Ti-alloy	1262	370	-	-	40	30	20	45	35	25	-	0.05-0.10	0.06-0.14	0.08-0.18	0.10-0.22	0.14-0.23	0.15-0.24		
H	Hardened steel	-	50-60HRC	-	-	-	-	-	-	-	-	-	-	-	-	-	-	-	-	
	Chilled cast iron	-	55HRC	-	-	-	-	-	-	-	-	-	-	-	-	-	-	-	-	

*The recommended cutting conditions always refer to general conditions. These cutting conditions should be adjusted according to the practical machine rigidity, tools, workpiece clamping and coolant.



Cutting Parameter Recommendation

Materials		WC drilling insert series grade application range & cutting parameter recommendation																
ISO	Material classification	Tensile strength (N/mm ²)	Hardness (HB)	Grade			Feed (mm/rev)						Feed (mm/rev)					
				AP301U	AP351U	AC301P	PVD Coated	P30-45	M30-45	-	S 30-45	-		-				
				Max	Med	Min	Max	Med	Min	Max	Med	Min	Max	Med	Min	Max	Med	Min
				Cutting speed (m/min)														
				Ø 16mm ~ Ø 20mm			Ø 20.5mm ~ Ø 25mm			Ø 25.5mm ~ Ø 30mm			Ø 31mm ~ Ø 41mm			Ø 41mm ~ Ø 58mm		
				WCMT 030204E-DU/DG			WCMT 040204E-DU/DG			WCMT 050308E-DU/DG			WCMT 06T308E-DU/DG			WCMT 080408E-DU/DG		
P	Unalloyed steel	<600	<180	260	240	224	220	185	150	200	175	150	0.04-0.065	0.07-0.09	0.07-0.10	0.08-0.11	0.09-0.13	
		<950	<280	250	210	170	200	170	140	190	162.5	135	0.05-0.07	0.09-0.09	0.07-0.10	0.08-0.11	0.09-0.13	
	Alloyed steel	700-950	200-280	240	200	160	190	160	130	180	150	120	0.05-0.09	0.065-0.14	0.08-0.16	0.10-0.18	0.10-0.20	
		950-1200	280-355	210	170	130	170	130	90	160	130	100	0.04-0.07	0.065-0.11	0.07-0.14	0.09-0.15	0.10-0.18	
M	Duplex stainless steel	1200-1400	355-415	170	140	110	160	120	80	140	110	80	0.04-0.065	0.05-0.9	0.07-0.10	0.08-0.12	0.09-0.13	
	Austenitic stainless steel	778	230	260	200	140	180	135	90	-	-	-	0.04-0.07	0.065-0.11	0.08-0.14	0.08-0.11	0.09-0.13	
	Precipitation-hardening stainless steel	675	200	220	170	120	120	65	60	-	-	-	0.04-0.065	0.065-0.10	0.08-0.12	0.08-0.10	0.08-0.11	
		1013	300	180	140	100	90	65	40	-	-	-	-	-	-	-	-	-
K	Grey cast iron	700	220	-	-	-	-	-	-	-	-	-	-	-	-	-	-	-
	Nodular cast iron	880	260	-	-	-	-	-	-	-	-	-	-	-	-	-	-	-
	Malleable cast iron	800	250	-	-	-	-	-	-	-	-	-	-	-	-	-	-	-
N	Aluminum	260	75	-	-	-	-	-	-	-	-	-	-	-	-	-	-	-
	Aluminum alloy	447	130	-	-	-	-	-	-	-	-	-	-	-	-	-	-	-
	Fe-based alloy	943	280	-	-	-	40	30	20	-	-	-	-	-	-	-	-	-
	Co-based alloy	1076	320	-	-	-	35	25	15	-	-	-	-	-	-	-	-	-
S	Ni-based alloy	1177	350	-	-	-	35	25	15	-	-	-	-	-	-	-	-	-
	Ti-alloy	1262	370	-	-	-	40	30	20	-	-	-	0.05-0.10	0.06-0.11	0.07-0.12	0.08-0.13	0.08-0.14	
H	Hardened steel	-	50-60HRC	-	-	-	-	-	-	-	-	-	-	-	-	-	-	-
	Chilled cast iron	-	55HRC	-	-	-	-	-	-	-	-	-	-	-	-	-	-	-

*The recommended cutting conditions always refer to general conditions. These cutting conditions should be adjusted according to the practical machine rigidity, tools, workpiece clamping and coolant.

Deep-hole Drilling Product Introduction

Achteck has general-purpose deep-hole drilling inserts, which offer high productivity for many industries: energy, engineering machinery, injection molding, aircraft, shipbuilding, military, etc. It can achieve good hole straightness in deep hole drilling and good surface finish. Existing geometries and grades cover steel, stainless steel and heat resistant alloy drilling.

Product application and features

- The inserts can be mounted on the deep-hole drilling head.
- AP301U(N) is the first choice for drilling steel and stainless steel
- All geometries offer good chip-breaking result
- Increased efficiency due to high feed rate
- Reduces the cost per hole



Grade	Coating	Workpiece material					
		P	M	K	N	S	H
AP301U(N)	PVD	●	●			○	

● Marked: 1st Choice ○ Marked: Supplemental application

ISO P : (P15-P35) General-purpose PVD coating with excellent wear-resistance and toughness.

ISO M :(M15-M35) General-purpose grade for ISO-M applications, PVD coating with excellent toughness and resistance to built-up edges.

Geometry Types and Features

Geometry	Edge shape	Application
DH		<ul style="list-style-type: none"> • For general purpose. • Suitable for high cutting speed and feed. • Good chip control in most of materials.
DL		<ul style="list-style-type: none"> • Suitable for long chip materials (such as low carbon alloyed steel and duplex stainless steel). • Obtain a reliable production process in drilling materials where chip jamming can be a problem.
LH		<ul style="list-style-type: none"> • With open geometry; • Suitable for high cutting speed and feed.

Drilling holder

Ejector Drill Matching Table

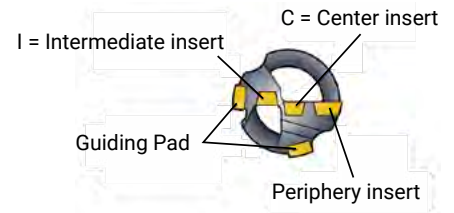

Hole diameter range (mm)	Center insert	Hole diameter range (mm)	Intermediate insert	Hole diameter range (mm)	Periphery insert	Hole diameter range (mm)	Guiding pad
26.00-28.70	EPMT 050308C	26.00-31.00	EPMT 050308I	26.00-31.00	APHT 060308P	26.00-31.00	GPAD-06A
28.71-33.99	EPMT 06T308C	31.01-34.99	EPMT 06T308I	31.01-38.99	APHT 08T308P	31.01-39.60	GPAD-07A
34.00-43.00	EPMT 08T308C	35.00-54.99	EPMT 08T308I	39.00-49.99	APHT 09T308P	39.61-47.00	GPAD-08A
43.01-47.00	EPMT 10T308C	55.00-65.00	EPMT 12T308I	50.00-65.00	APHT 11T308P	47.01-54.99	GPAD-10A
47.01-49.99	EPMT 12T308C	-	-	-	-	55.00-65.00	GPAD-12A
50.00-57.99	EPMT 10T308C	-	-	-	-	-	-
58.00-65.00	EPMT 12T308C	-	-	-	-	-	-

Deep-Hole Drilling Inserts
DH geometry

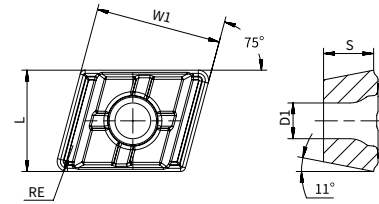

Center insert	Product code	L	W1	S	RE	D1	Competitor's description	Stock
	EPMT 050308C-DH AP301U(N)	5.56	8	3.18	0.8	2.5	800-050308M-C-G 1025	●
	EPMT 06T308C-DH AP301U(N)	6.35	9.87	3.97	0.8	2.8	800-06T308M-C-G 1025	●
	EPMT 08T308C-DH AP301U(N)	7.94	9.87	3.97	0.8	2.8	800-08T308M-C-G 1025	●
	EPMT 10T308C-DH AP301U(N)	9.53	9.87	3.97	0.8	2.8	800-10T308M-C-G 1025	●
	EPMT 12T308C-DH AP301U(N)	12.7	9.87	3.97	0.8	2.8	800-12T308M-C-G 1025	●

● Stock available

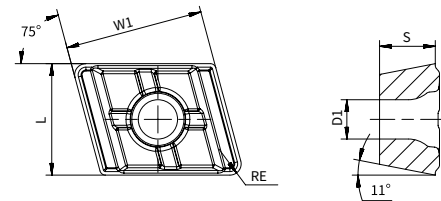

Intermediate insert	Product code	L	W1	S	RE	D1	Competitor's description	Stock
	EPMT 050308I-DH AP301U(N)	5.56	8	3.18	0.8	2.5	800-050308M-I-G 1025	●
	EPMT 06T308I-DH AP301U(N)	6.35	9.87	3.97	0.8	2.8	800-06T308M-I-G 1025	●
	EPMT 08T308I-DH AP301U(N)	7.94	9.87	3.97	0.8	2.8	800-08T308M-I-G 1025	●
	EPMT 12T308I-DH AP301U(N)	12.7	9.87	3.97	0.8	2.8	800-12T308M-I-G 1025	●

● Stock available

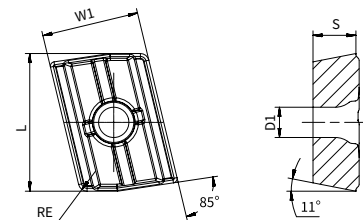

Periphery insert	Product code	L	W1	S	RE	D1	Competitor's description	Stock
	APHT 060308P-DH AP301U(N)	6.5	8	3.18	0.8	2.5	800-060308H-P-G 1025	●
	APHT 08T308P-DH AP301U(N)	8.5	9	3.97	0.8	2.8	800-08T308H-P-G 1025	●
	APHT 09T308P-DH AP301U(N)	9.66	9	3.97	0.8	2.8	800-09T308H-P-G 1025	●
	APHT 11T308P-DH AP301U(N)	12.75	9	3.97	0.8	2.8	800-11T308H-P-G 1025	●

● Stock available

Drilling holder

Deep-Hole Drilling Inserts
DL geometry

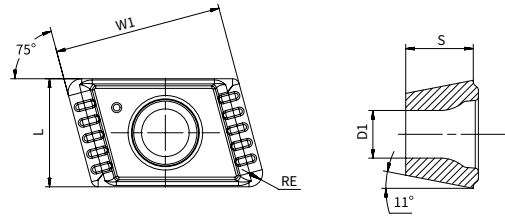

Intermediate insert	Product code	L	W1	S	RE	D1	Competitor's description	Stock
	EPMT 050308I-DL AP301U(N)	5.56	8	3.18	0.8	2.5	800-050308M-I-L 1025	●
	EPMT 06T308I-DL AP301U(N)	6.35	9.87	3.97	0.8	2.8	800-06T308M-I-L 1025	●
	EPMT 08T308I-DL AP301U(N)	7.94	9.87	3.97	0.8	2.8	800-08T308M-I-L 1025	●
	EPMT 12T308I-DL AP301U(N)	12.7	9.87	3.97	0.8	2.8	800-12T308M-I-L 1025	●

● Stock available

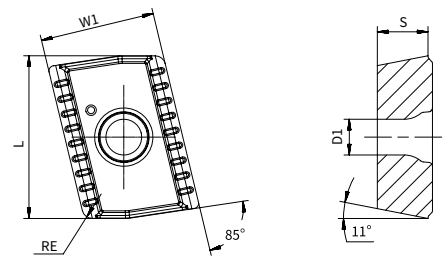

Periphery insert	Product code	L	W1	S	RE	D1	Competitor's description	Stock
	APHT 060308P-DL AP301U(N)	6.5	8	3.18	0.8	2.5	800-060308H-P-L 1025	●
	APHT 08T308P-DL AP301U(N)	8.5	9	3.97	0.8	2.8	800-08T308H-P-L 1025	●
	APHT 09T308P-DL AP301U(N)	9.66	9	3.97	0.8	2.8	800-09T308H-P-L 1025	●
	APHT 11T308P-DL AP301U(N)	12.75	9	3.97	0.8	2.8	800-11T308H-P-L 1025	●

● Stock available

Deep-Hole Drilling Inserts
DH geometry

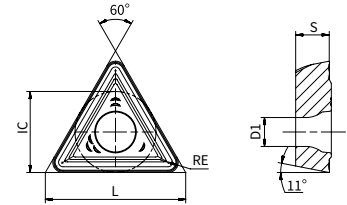

Center/Intermediate insert	Product code	L	IC	S	RE	D1	Competitor's description	Stock
	TPMT 16T312R-DH AP301U(N)	16.5	9.53	3.97	1.2	3.4	TPMT 16T312R-23 1025	●
	TPMT 220612R-DH AP301U(N)	22	12.7	6.35	1.2	4.4	TPMT 220612R-23 1025	●

● Stock available

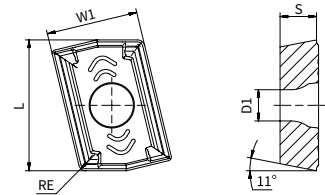

Periphery insert	Product code	L	W1	S	RE	D1	Competitor's description	Stock
	APMT 13T308-DH AP301U(N)	14.6	10	3.97	0.8	3.4	R424.9-13T308-23 1025	●
	APMT 180608-DH AP301U(N)	20.6	11.5	6.35	0.8	4.4	R424.9-180608-23 1025	●

● Stock available

Deep-Hole Drilling Inserts
LH geometry

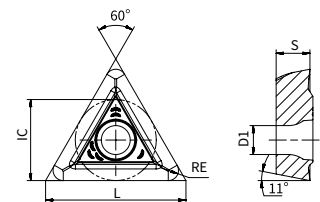

Center/Intermediate insert	Product code	L	IC	S	RE	D1	Competitor's description	Stock
	TPMT 16T312R-LH AP301U(N)	16.5	9.525	3.97	1.2	3.4	TPMT 16T312R-22 1025	●
	TPMT 220612R-LH AP301U(N)	22	12.7	6.35	1.2	4.4	TPMT 220612R-22 1025	●

● Stock available

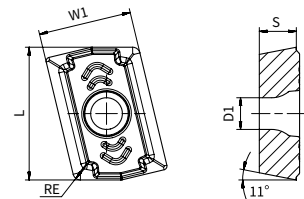



Periphery insert	Product code	L	W1	S	RE	D1	Competitor's description	Stock
	APMT 13T308-LH AP301U(N)	14.6	10	3.97	0.8	3.4	R424.9-13T308-22 1025	●
	APMT 180608-LH AP301U(N)	20.6	11.5	6.35	0.8	4.4	R424.9-180608-22 1025	●

● Stock available

Drilling holder

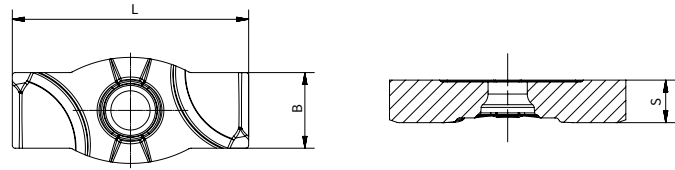
Deep-Hole Drilling Inserts
Guiding pad



Guiding pad	Product code	B	L	S	Competitor's description	Stock
	GPAD-06A AC301K	6.00	18.00	3.00	800-06A PM1	●
	GPAD-07A AC301K	7.00	20.00	3.50	800-07A PM1	●
	GPAD-08A AC301K	8.00	25.00	4.50	800-08A PM1	●
	GPAD-10A AC301K	10.00	30.00	4.50	800-10A PM1	●
	GPAD-12A AC301K	12.00	35.00	5.50	800-12A PM1	●

● Stock available

TPMX Series

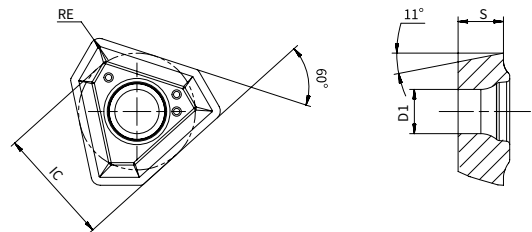

Sharp	Product code	S	IC	RE	D1	Competitor's description	Stock
	TPMX 1403R-DH AP301U(N)	3.50	8.45	0.80	2.87	TPMX 1403RG TT9030	●
	TPMX 1704R-DH AP301U(N)	4.00	10.30	0.80	3.90	TPMX 1704RG TT9030	●
	TPMX 2405R-DH AP301U(N)	5.50	14.20	1.20	4.40	TPMX 2405RG TT9030	●
	TPMX 2405L-DH AP301U(N)	5.50	14.20	1.20	4.40	TPMX 2405LG TT9030	●
	TPMX 2807R-DH AP301U(N)	7.50	17.00	1.60	5.50	TPMX 2807RG TT9030	●

● Stock available

Recommended Cutting Speed for Materials(Dia 25.00-65.00mm)

	Workpiece material		Brinell hardness (HB)	Grade			Cutting speed Vc m/min	Feed fn mm/r		
				Insert				Drilling dia mm		
				P	I	C		25.00-43.00	43.01-65.00	
P	Unalloyed steel	C=0.05-0.10%	125	AP301U(N)			70-130	0.11-0.41	0.14-0.45	
		C=0.10-0.25%	125				70-130	0.11-0.41	0.14-0.45	
		C=0.25-0.55%	150				70-130	0.11-0.41	0.14-0.45	
		C=0.55-0.80%	170				70-130	0.11-0.41	0.14-0.45	
	High carbon steel	Carbon tool steel	210	AP301U(N)			70-120	0.11-0.41	0.20-0.45	
	Low-alloyed steel	Non-Hardened		180	AP301U(N)			55-110	0.11-0.41	0.20-0.45
		Tempered		275				70-120	0.11-0.41	0.20-0.45
		Tempered		350				70-120	0.11-0.41	0.20-0.45
	High-alloyed steel	Annealed		200	AP301U(N)			55-110	0.11-0.38	0.20-0.40
		Hardened tool steel		325				55-110	0.20-0.38	0.20-0.40
Cast steel	Non-alloyed steel		180	AP301U(N)			55-110	0.11-0.41	0.20-0.45	
	Low-alloy (alloy<5%)		200				55-110	0.11-0.41	0.20-0.45	
M	Stainless steel	Non-Hardened/Ferritic/martensitic		200	AP301U(N)			40-110	0.11-0.41	0.20-0.45
		Austenitic		200				40-110	0.11-0.41	0.20-0.45
		Austenitic, precipitation hardened (PH)		300				40-110	0.11-0.33	0.20-0.35
		Austenitic/ferritic, duplex		230				40-80	0.11-0.33	0.20-0.35
K	Malleable cast iron	Ferritic		200	AP301U(N)			80-120	0.11-0.38	0.24-0.41
		Pearlitic		260				80-120	0.11-0.38	0.24-0.41
	Grey cast iron	Low tensile strength		180	AP301U(N)			60-110	0.11-0.38	0.24-0.41
		High tensile strength		245				60-110	0.11-0.38	0.24-0.41
	Nodular cast iron	Ferritic		160	AP301U(N)			50-110	0.11-0.38	0.24-0.41
		Pearlitic		250				50-110	0.11-0.38	0.24-0.41
GGV (CGI)				230						
N	Wrought aluminium alloys	non-aging		30	AP301U(N)			65-150	0.09-0.33	0.20-0.33
		aged		100				65-150	0.09-0.33	0.20-0.33
	Cast aluminium alloys	≤ 12% Si, non-aging		75	AP301U(N)			65-150	0.09-0.33	0.20-0.33
		≤ 12% Si, aged		90				65-150	0.09-0.33	0.20-0.33
		> 12% Si, non-aging		130				65-150	0.09-0.33	0.20-0.33
	Magnesium alloy			70						
	Copper and copper alloys (bronze/brass)	Unalloyed, electrolytic copper		100	AP301U(N)			65-150	0.09-0.33	0.20-0.33
		Brass, bronze, red brass		90	AP301U(N)			65-150	0.09-0.33	0.20-0.33
Cu alloys, short-chip		110	65-150	0.09-0.33				0.20-0.33		
High tensile, Ampco alloy		300	65-150	0.09-0.33				0.20-0.33		
S	Heat-resistant alloys	Fe-based annealed		200	AP301U(N)			10-55	0.09-0.30	0.20-0.33
		Fe-based hardened		280				10-55	0.09-0.30	0.20-0.33
		Ni or Co-based annealed		250				10-55	0.09-0.30	0.20-0.33
		Ni or Co-based hardened		350				10-55	0.09-0.30	0.20-0.33
		Ni or Co-based cast		320				10-55	0.09-0.30	0.20-0.33
	Titanium alloys	Pure titanium		200	AP301U(N)			30-60	0.09-0.30	0.20-0.33
		α alloys		375				30-60	0.09-0.30	0.20-0.33
		α and β alloys		375				30-60	0.09-0.30	0.20-0.33
		β alloys		410				30-60	0.09-0.30	0.20-0.33
H	Hardened steel	Hardened and tempered		43-47 HRC						
	Chilled cast iron			47-60 HRC						

*) Insert position-P, I, C
 P=peripheral insert, I=intermediate insert, C=center insert

Drilling holder

Recommended Cutting Speed for Materials(Dia ≥63.50mm)

	Workpiece material		Brinell hardness (HB)	Grade			Cutting speed Vc m/min	Feed fn mm/r	
				Insert				Drilling dia mm	
				P	I	C		≥63.50	
P	Unalloyed steel	C=0.05-0.10%	125	AP301U(N)			80-100	0.18-0.35	
		C=0.10-0.25%	125				80-100	0.18-0.35	
		C=0.25-0.55%	150				80-100	0.18-0.35	
		C=0.55-0.80%	170				80-100	0.18-0.35	
	High carbon steel	Carbon tool steel	210	AP301U(N)			70-100	0.18-0.35	
	Low-alloyed steel	Non-Hardened		180	AP301U(N)			60-100	0.16-0.35
		Tempered		275				70-100	0.18-0.30
		Tempered		350				70-100	0.18-0.30
	High-alloyed steel	Annealed		200	AP301U(N)			60-100	0.16-0.30
		Hardened tool steel		325				60-100	0.16-0.30
Cast steel	Non-alloyed steel		180	AP301U(N)			50-100	0.15-0.30	
	Low-alloy (alloy<5%)		200				50-100	0.15-0.30	
M	Stainless steel	Non-Hardened/Ferritic/martensitic		200	AP301U(N)			50-90	0.16-0.35
		Austenitic		200				50-90	0.16-0.35
		Austenitic, precipitation hardened (PH)		300					
		Austenitic/ferritic, duplex		230					
K	Malleable cast iron	Ferritic		200	AP301U(N)				
		Pearlitic		260					
	Grey cast iron	Low tensile strength		180	AP301U(N)				
		High tensile strength		245					
	Nodular cast iron	Ferritic		160	AP301U(N)				
		Pearlitic		250					
	GGV (CGI)		230						
N	Wrought aluminium alloys	non-aging		30	AP301U(N)			65-130	0.10-0.30
		aged		100				65-130	0.10-0.30
	Cast aluminium alloys	≤ 12% Si, non-aging		75	AP301U(N)			65-130	0.10-0.30
		≤ 12% Si, aged		90				65-130	0.10-0.30
		> 12% Si, non-aging		130				65-130	0.10-0.30
	Magnesium alloy			70					
	Copper and copper alloys (bronze/brass)	Unalloyed, electrolytic copper		100	AP301U(N)			65-130	0.10-0.30
		Brass, bronze, red brass		90				65-130	0.10-0.30
Cu alloys, short-chip		110	65-130	0.10-0.30					
High tensile, Ampco alloy		300	65-130	0.10-0.30					
S	Heat-resistant alloys	Fe-based annealed		200	AP301U(N)			20-65	0.15-0.30
		Fe-based hardened		280				20-65	0.15-0.30
		Ni or Co-based annealed		250				20-65	0.15-0.30
		Ni or Co-based hardened		350				20-65	0.15-0.30
		Ni or Co-based cast		320					
	Titanium alloys	Pure titanium		200	AP301U(N)			30-100	0.15-0.30
α alloys		375	30-100	0.15-0.30					
α and β alloys		375	30-100	0.15-0.30					
β alloys		410	30-100	0.15-0.30					
H	Hardened steel	Hardened and tempered		43-47 HRC					
	Chilled cast iron			47-60 HRC					

*) Insert position-P, I, C
P=peripheral insert, I=intermediate insert, C=center insert

ACHTTECK

www.achtecktool.com/en

THE EXPERT OF DIFFICULT MACHINING



Boring Tools

Overview of Boring Tools

<p>ARB double edge rough boring series</p> <ul style="list-style-type: none"> - Double edge rough boring tools - for blind hole - Double edge rough boring tools - for through hole - Rough back-boring tools 	<p>MLR series large diameter boring tool</p> <ul style="list-style-type: none"> - Standard rough boring - Lightweight rough boring
	
<p>AFB fine boring series</p> <ul style="list-style-type: none"> - Fine boring with cartridge A - Fine boring with cartridge B - Fine boring with cartridge C 	<p>MLF series large diameter fine boring tool</p> <ul style="list-style-type: none"> - Standard fine boring - Lightweight fine boring
	
<p>DFB anti-vibration fine boring series</p> <ul style="list-style-type: none"> - Mono-block anti-vibration fine boring tool 	<p>EFB external diameter fine boring series</p> <ul style="list-style-type: none"> - External diameter fine boring - Large external diameter fine boring
	

ARB Double Edge Rough Boring Series

Diameter range $\Phi 20-203\text{mm}$.
 Cover wide applications.
 High precision, high rigidity, flexible on tool combination.
 Adjusting scale marked on tool body, easy to handle.

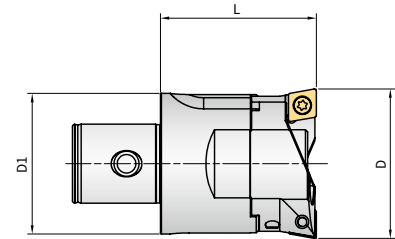

Boring tool denomination

ARB- - - - -AK- -W
 1 2 3 4 5

"1" Series name
 "2" Minimum boring diameter
 "3" Maximum boring diameter
 "4" Coupling size:
 AK1/AK2/AK3/AK4/AK5/AK6/AK7
 "5" W means without cartridge,
 L means extra long rough boring

Dia range D	Product code	Coupling	D1	L	Cartridge (● Standard ○ Option)	Screw	weight (Kg)
20-26	ARB-020-026-AK1	AK1	19	32.5	RC-020-CC06 ●	SH040160	0.07
					RC-020-SC06 ○		
25-33	ARB-025-033-AK2	AK2	24	35.5	RC-025-CC06 ●	SH050200	0.12
					RC-025-SC06 ○		
32-42	ARB-032-042-AK3	AK3	31	40	RC-032-CC09 ●	SH060200	0.2
					RC-032-SC09 ○		
41-54	ARB-041-054-AK4	AK4	39	47	RC-041-CC09 ●	SH080250	0.38
					RC-041-SC09 ○		
53-70	ARB-053-070-AK5	AK5	50	57	RC-053-CC12 ●	SH100300	0.75
					RC-053-SC12 ○		
68-90	ARB-068-110-AK6	AK6	63	71	RC-068-CC12 ●	SH100350	1.6
					RC-068-SC12 ○		
88-110	ARB-068-110-AK6-L	AK6	63	71	RC-088-CC12 ●		1.8
					RC-088-SC12 ○		
98-126	ARB-098-153-AK6	AK6	63	71	RC-098-CC12 ●	SH120400	2.3
					RC-098-SC12 ○		
125-153	ARB-098-153-AK6-L	AK6	63	71	RC-125-CC12 ●	SH120400	2.6
					RC-125-SC12 ○		
98-126	ARB-098-153-AK7	AK7	90	87	RC-098-CC12 ●		3.9
					RC-098-SC12 ○		
125-153	ARB-098-153-AK7-L				RC-125-CC12 ●	4.1	
					RC-125-SC12 ○		
148-176	ARB-148-203-AK6	AK6	63	71	RC-098-CC12 ●	2.9	
					RC-098-SC12 ○		
175-203	ARB-148-203-AK6-L				RC-125-CC12 ●	3.2	
					RC-125-SC12 ○		

- Tool body is assembled with blind hole boring cartridges as standard package. For through hole, the tool body without cartridge need to be ordered separately. Example: ARB-148-203-AK6-W & RC-098-SC12*2.
- Tool body without cartridge also can be ordered. Example: ARB-020-026-AK1-W.
- Spare parts including: clamping bolt, washer, wrench. The inserts need to be ordered separately.
- ARB double edge rough boring tool is with internal coolant.
- The boring tool must be assembled properly with all the screws and bolts tightened.
- For the ideal axial runout, the inserts need to be indexed at the same time.

ARB Series Double Edge Rough Boring Tools
 Standard: Rough boring cartridge for blind hole

Boring tool denomination "1" Series name
 "2" Minimum boring diameter
 "3" Insert
 "4" B means reverse boring,
 Without B means front boring

RC-__-__-CC-__-B
 1 2 3 4

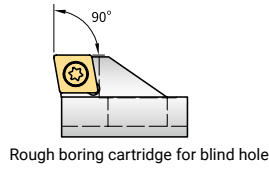

Cartridge	Tool body	Insert (Option)	Screw & Wrench
RC-020-CC06	ARB-020-026-AK1-W	CC__ 0602__	ST025060 FT-T8
RC-025-CC06	ARB-025-033-AK2-W		
RC-032-CC09	ARB-032-042-AK3-W	CC__ 09T3__	ST040100 FT-T15
RC-041-CC09	ARB-041-054-AK4-W		
RC-053-CC12	ARB-053-070-AK5-W	CC__ 1204__	ST050120 FT-T20
RC-068-CC12	ARB-068-110-AK6-W		
RC-088-CC12	ARB-068-110-AK6-W		
RC-098-CC12	ARB-098-153-AK6-W		
	ARB-098-153-AK7-W		
RC-125-CC12	ARB-148-203-AK6-W		
	ARB-098-153-AK6-W		
	ARB-098-153-AK7-W		
	ARB-148-203-AK6-W		

ARB Series Double Edge Rough Boring Tools
 Option: Rough boring cartridge for through hole

Boring tool denomination "1" Series name
 "2" Minimum boring diameter
 "3" Insert
 "4" B means reverse boring,
 Without B means front boring

RC-__-__-CC-__-B
 1 2 3 4

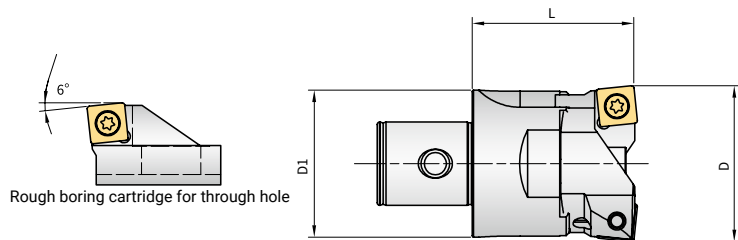

Cartridge	Tool body	Insert (Option)	Screw & Wrench
RC-020-SC06	ARB-020-026-AK1-W	SC__ 0602__	ST025060 FT-T8
RC-025-SC06	ARB-025-033-AK2-W		
RC-032-SC09	ARB-032-042-AK3-W	SC__ 09T3__	ST040100 FT-T15
RC-041-SC09	ARB-041-054-AK4-W		
RC-053-SC12	ARB-053-070-AK5-W	SC__ 1204__	ST050120 FT-T20
RC-068-SC12	ARB-068-110-AK6-W		
RC-088-SC12	ARB-068-110-AK6-W		
RC-098-SC12	ARB-098-153-AK6-W		
	ARB-098-153-AK7-W		
RC-125-SC12	ARB-148-203-AK6-W		
	ARB-098-153-AK6-W		
	ARB-098-153-AK7-W		
	ARB-148-203-AK6-W		

ARB Rough Reverse Boring Series

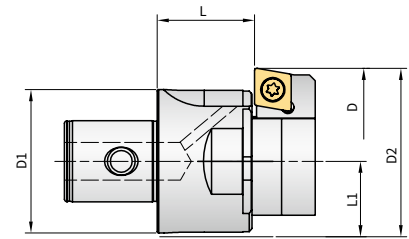

Min. through hole diameter $D2 = L1 + (\text{reverse boring diameter } D/2)$

Dia range D	Product code	Coupling	Reverse boring cartridge (Option)	D1	L	Screw	L1	Weight (Kg)	Insert (Option)	Screw & Wrench		
25-31	ARB-020-026-AK1-W	AK1	RC-025-CC06-B	18.7	21.5	SH040160	10.0	0.06	CC_ _ 0602_ _	ST025060 FT-T8		
30-35			RC-030-CC06-B					0.06				
32-40	ARB-025-033-AK2-W	AK2	RC-032-CC06-B	23.5	23.5	SH050200	12.5	0.11				
39-47			RC-039-CC06-B					0.11				
41-51	ARB-032-042-AK3-W	AK3	RC-041-CC09-B	30.5	23.5	SH060200	16.0	0.18			CC_ _ 09T3_ _	ST040100 FT-T15
50-60			RC-05060-CC09-B					0.19				
50-63	ARB-041-054-AK4-W	AK4	RC-05063-CC09-B	38.5	28.5	SH080250	20.0	0.36				
61-74			RC-061-CC09-B					0.38				
65-82	ARB-053-070-AK5-W	AK5	RC-065-CC12-B	49.5	33.5	SH100300	25.5	0.7	CC_ _ 1204_ _	ST050120 FT-T20		
78-95			RC-078-CC12-B					0.75				
80-102	ARB-068-110-AK6-W	AK6	RC-080-CC12-B	63.0	45.5	SH100350	32.5	1.5				
100-122			RC-100-CC12-B					1.6				
98-126	ARB-098-153-AK6-W	AK6	RC-098-CC12-B	63.0	45.5	SH120400	46.5	2.25				
125-153			RC-125-CC12-B					2.45				

● Reverse boring tool: please order tool body without cartridge and choose a cartridge, e.g. ARB-020-026-AK1-W & RC-025-CC06-B.

Example of tool selection: Reverse boring $\phi 26$, find the corresponding tool body and boring cartridge ARB-020-026-AK1-W, RC-025-CC06-B according to the bore diameter; the minimum tool diameter is $D2 = 10 + 26/2$ which is 23mm.

MLR Series Large Diameter Rough Boring Tools

Diameter range \varnothing 150mm- \varnothing 850mm.
 Modular design, flexible on tool combination. Easy to handle.
 To reduce the tool weight, lightweight rough boring tool is available

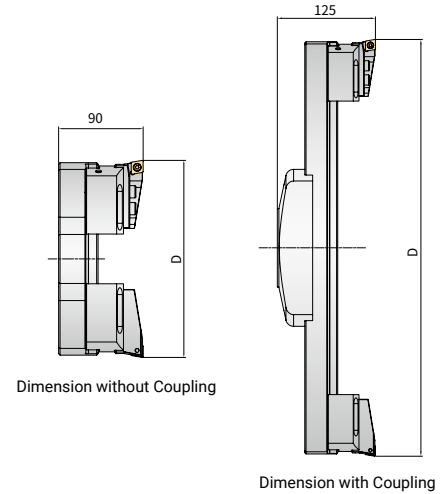

Boring tool denomination "1" Series name
 "2" Minimum boring diameter
 "3" Maximum boring diameter
 "4" LD means light weight, without LD means standard

MLR-__-__-__-LD
 1 2 3 4

Standard (With Steel Boring Bridge)

Dia range D	Product code	Weight (Kg)	Coupling	Steel bridge	Slider	Cartridge	Insert (Option)
150-210	MLR-150-210	5.5	/	BS-150-210	RB-150	RC-150	CC_1204
210-290	MLR-210-290	6.7		BS-210-290			
290-370	MLR-290-370	8.1		BS-290-370			
370-450	MLR-370-450	9.8		BS-370-450			
450-530	MLR-450-530	11.4		BS-450-530			
530-610	MLR-530-610	17.2	LP40-200	BS-530-610	RB-150	RC-150	CC_1204
610-690	MLR-610-690	18.7		BS-610-690			
690-770	MLR-690-770	20.4		BS-690-770			
770-850	MLR-770-850	22.7		BS-770-850			

Lightweight (With Aluminium Boring Bridge)

Dia range D	Product code	Weight (Kg)	Coupling	Aluminium bridge	Slider	Cartridge	Insert (Option)
150-210	MLR-150-210-LD	3.9	/	BS-150-210-LD	RB-150	RC-150	CC_1204
210-290	MLR-210-290-LD	4.3		BS-210-290-LD			
290-370	MLR-290-370-LD	5.0		BS-290-370-LD			
370-450	MLR-370-450-LD	5.5		BS-370-450-LD			
450-530	MLR-450-530-LD	6.0		BS-450-530-LD			
530-610	MLR-530-610-LD	11.2	LP40-200	BS-530-610-LD	RB-150	RC-150	CC_1204
610-690	MLR-610-690-LD	12.0		BS-610-690-LD			
690-770	MLR-690-770-LD	13.2		BS-690-770-LD			
770-850	MLR-770-850-LD	13.9		BS-770-850-LD			

- Rough boring tool assembled with cartridges as standard package, include bridge, slider, cartridge, some models include coupling, the inserts not are included.
- For the ideal axial runout, the inserts need to be indexed at the same time.

Boring

AFB Fine Boring Series

Diameter range \varnothing 20mm- \varnothing 203mm.

Fine boring cartridge can be switched for different applications.

The precision screw is located inside the tool body, avoiding the impact of chips, corrosion and rust, extend the overall tool life.

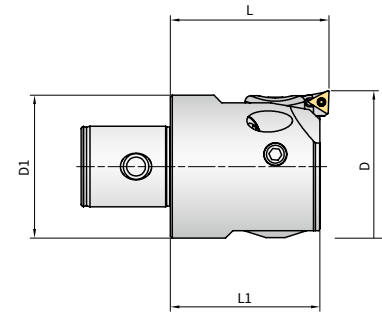

"1" Series name
 "2" Minimum boring diameter
 "3" Maximum boring diameter
 "4" Coupling size
 "5" "W" means without cartridge,
 Without "W" means including cartridge A

Boring tool denomination

AFB-__-__-__-AK_-W
 1 2 3 4 5

Product code	Coupling	Cartridge (● Standard ○ Option)	Dia range D	L	L1	D1	Weight (Kg)	Insert (Option)
AFB-020-036-AK1	AK1	FCT-10A ●	20-26	32.5	30.5	19	0.07	TP__ 0802__
		FCT-10B ○	25-31					
		FCT-10C ○	30-36					
AFB-025-047-AK2	AK2	FCT-20A ●	25-33	35.5	33	24	0.12	
		FCT-20B ○	35-40					
		FCT-20C ○	39-47					
AFB-032-060-AK3	AK3	FCT-30A ●	32-42	40	37	31	0.22	
		FCT-30B ○	41-51					
		FCT-30C ○	50-60					
AFB-041-074-AK4	AK4	FCT-40A ●	41-54	47	43	40	0.42	
		FCT-40B ○	50-63					
		FCT-40C ○	61-74					
AFB-053-095-AK5	AK5	FCT-50A ●	53-70	57	52	50	0.85	
		FCT-50B ○	65-82					
		FCT-50C ○	78-95					
AFB-068-150-AK6	AK6	FCT-60A ●	68-100	71	67	64	1.85	TC__ 1102__
		FCT-60B ○	94-126					
		FCT-60C ○	118-150					
AFB-100-203-AK6	AK6	FCT-60A ●	100-153	71	67	64	2.7	
		FCT-60B ○	126-179					
		FCT-60C ○	150-203					
AFB-100-203-AK7	AK7	FCT-60A ●	100-153	87	83	90	4.05	
		FCT-60B ○	126-179					
		FCT-60C ○	150-203					

- Minimum scale adjustment range of 0.002mm.
- Tool body assembled with cartridge A as standard package. For example: AFB-020-026-AK1-W & FCT-10B.
- Insert need to be ordered separately.
- All AFB boring tool is with internal coolant.
- Regularly use grease for the internal tooling lubrication to extend the boring holder tool life.

Fine Boring Series

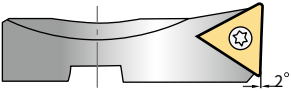
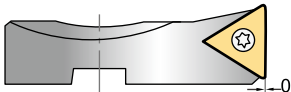
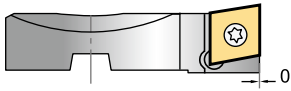
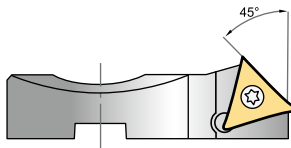
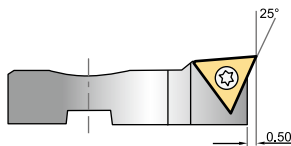
Cartridge	Product code	Fine boring head	Dia range D	Insert (Option)	Screw & Wrench		
	FCT-10A	AFB-020-036-AK1	20-26	TP__0802__	ST020040 FT-T6		
	FCT-10B		25-31				
	FCT-10C		30-36				
	FCT-20A	AFB-025-047-AK2	25-33				
	FCT-20B		35-40				
	FCT-20C		39-47				
	FCT-30A	AFB-032-060-AK3	32-42				
	FCT-30B		41-51				
	FCT-30C		50-60				
	FCT-40A	AFB-041-074-AK4	41-54			TC__1102__	ST025060 FT-T8
	FCT-40B		50-63				
	FCT-40C		61-74				
	FCT-50A	AFB-053-095-AK5	53-70				
	FCT-50B		65-82				
	FCT-50C		78-95				
	FCT-60A	AFB-068-150-AK6	68-153				
FCT-60B	AFB-100-203-AK6	94-179					
FCT-60C	AFB-100-203-AK7	150-203					
	FCT-40A00	AFB-041-074-AK4	41-54	TC__1102__	ST025060 FT-T8		
	FCT-50A00	AFB-053-095-AK5	53-70				
	FCT-60A00	AFB-068-150-AK6	68-100				
		AFB-100-203-AK6	100-153				
	FCC-40A00	AFB-041-074-AK4	41-54	CC__0602__	ST040100 FT-T15		
	FCC-50A00	AFB-053-095-AK5	53-70				
	FCC-60A00	AFB-068-150-AK6	68-100				
		AFB-100-203-AK6	100-153				
	FCT-40A45	AFB-041-074-AK4	41-54	TC__1102__	ST025060 FT-T8		
	FCT-50A45	AFB-053-095-AK5	53-70				
	FCT-60A45	AFB-068-150-AK6	68-100				
		AFB-100-203-AK6	100-153				
		AFB-100-203-AK7	100-153				
	FCT-30A25	AFB-032-060-AK3	32-42	TP__0802__	ST020040 FT-T6		
	FCT-40A25	AFB-041-074-AK4	41-54				
	FCT-50A25	AFB-053-095-AK5	53-70				
	FCT-60A25	AFB-068-150-AK6	68-100	TC__1102__	ST025060 FT-T8		
		AFB-100-203-AK6	100-153				
		AFB-100-203-AK7	100-153				



MLF Series Large Diameter Fine Boring Tool

Diameter range \varnothing 150mm- \varnothing 850mm.
 Modular design, for both tool body balancing and machining precision.
 Flexible on tool combination. Easy to use.
 Including steel or Aluminium bridge.

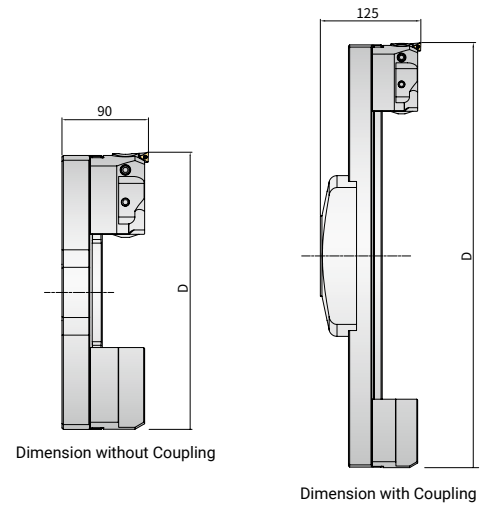

Boring tool denomination
 MLR- - - -LD
 1 2 3 4

"1"Series name
 "2"Minimum boring diameter
 "3"Maximum boring diameter
 "3""LD"means light weight, without "LD" means standard

Standard (With Steel Boring Bridge)

Dia range D	Product code	Weight (Kg)	Coupling	Steel boring bridge	Slider	Balance Block	Cartridge	Insert (Option)
150-210	MLF-150-210	6.2	/	BS-150-210	FB-150	BB-150	FCT-60A (Standard) FCT-60B FCT-60C	TC_ _ 1102_ _
210-290	MLF-210-290	7.5		BS-210-290				
290-370	MLF-290-370	8.5		BS-290-370				
370-450	MLF-370-450	10.2		BS-370-450				
450-530	MLF-450-530	11.6		BS-450-530				

Aluminium Boring Bridge

Dia range D	Product code	Weight (Kg)	Coupling	Aluminium bridge	Slider	Balance Block	Cartridge	Insert (Option)
150-210	MLF-150-210-LD	4.6	/	BS-150-210-LD	FB-150	BB-150	FCT-60A (Standard) FCT-60B FCT-60C	TC_ _ 1102_ _
210-290	MLF-210-290-LD	5.1		BS-210-290-LD				
290-370	MLF-290-370-LD	5.5		BS-290-370-LD				
370-450	MLF-370-450-LD	5.9		BS-370-450-LD				
450-530	MLF-450-530-LD	6.2		BS-450-530-LD				
530-610	MLF-530-610-LD	11.5	LP40-200	BS-530-610-LD	FB-150	BB-200	FCT-60A (Standard) FCT-60B FCT-60C	TC_ _ 1102_ _
610-690	MLF-610-690-LD	12.3		BS-610-690-LD				
690-770	MLF-690-770-LD	13.6		BS-690-770-LD				
770-850	MLF-770-850-LD	14.2		BS-770-850-LD				

- Assembled bridge type finish boring tool include boring bridge, slider, FCT-60A cartridge, and some models include coupling plate. The inserts are not included.
- If a larger boring diameter is required with cartridge B or C, an order can be placed after contact with a sales engineer.
 Example: MLF-150-210-W & FCT-60B.

MLF Big Diameter Series Fine Boring Tool

Dia range	Product code	Cartridge
150-210	MLF-150-210-W	FCT-60A
176-236		FCT-60B
200-260		FCT-60C
210-290	MLF-210-290-W	FCT-60A
236-315		FCT-60B
260-340		FCT-60C
290-370	MLF-290-370-W	FCT-60A
316-396		FCT-60B
340-420		FCT-60C
370-450	MLF-370-450-W	FCT-60A
396-476		FCT-60B
420-500		FCT-60C
450-530	MLF-450-530-W	FCT-60A
476-556		FCT-60B
500-580		FCT-60C
530-610	MLF-530-610-W	FCT-60A
556-636		FCT-60B
580-660		FCT-60C
610-690	MLF-610-690-W	FCT-60A
636-716		FCT-60B
660-740		FCT-60C
690-770	MLF-690-770-W	FCT-60A
716-746		FCT-60B
740-820		FCT-60C
770-850	MLF-770-850-W	FCT-60A
796-876		FCT-60B
820-900		FCT-60C

DFB Series Anti-Vibration Fine Boring Tool

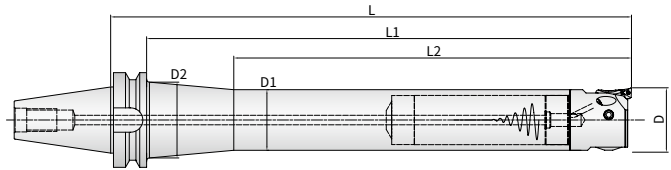

"1" Series name
 "2" Minimum boring diameter
 "3" Maximum boring diameter
 "4" Coupling size. The coupling is BBT50
 "5" Effective boring depth

DFB- - - -BBT50-L- -
 1 2 3 4 5

Product code	Cartridge	Dia range D	L2	L1	L	Weight (Kg)	D1	D2	Insert (Option)
DFB-041-074-BBT50-L280	FCT-40A	41-54	280	320	358	7.4	40	55	TC_ _ 1102_ _
	FCT-40B	50-63							
	FCT-40C	61-74							
DFB-053-095-BBT50-L350	FCT-50A	53-70	350	400	438	11	50	56	
	FCT-50B	65-82							
	FCT-50C	78-95							
DFB-068-150-BBT50-L450	FCT-60A	68-100	450	512	550	18.9	64	80	
	FCT-60B	94-126							
	FCT-60C	118-150							
DFB-100-203-BBT50-L525	FCT-60A	100-153	525	525	563	23.5	70	85	
	FCT-60B	126-179							
	FCT-60C	150-203							

- Tool body assembled with FC*-60A fine boring cartridge as standard package.
 - Tool body and cartridge need to be ordered separately if FC*-60B or FC*-60C cartridge is needed. Example: DFB-041-074-BBT50-L280 and FCT-40B.
 - Inserts need to be ordered separately.
- Note: Limited stock, please contact our sales engineer for details on stock availability.

SFB Series Small Diameter Fine Boring Tools
Small diameter fine boring head

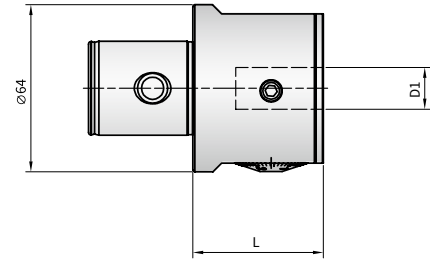

Boring tool denomination

SFB-016-AK6
1 2 3

"1" series name
"2" boring head clamping diameter D1
"3" coupling size, coupling specification AK6

Product code	Coupling	D	D1	L	Weight (Kg)
SFB-016-AK6	AK6	64	16	50	1.25

Steel Boring Bars for Small Diameter Fine Boring Heads



Boring tool denomination

BAR-16 _ _ - _
1 2 3 4

"1" series name
"2" shank diameter of the boring bar
"3" minimum machining diameter
"4" maximum depth of machining

Product code	Dia range	D	D1	L	L1	L2	Insert (Option)	Screw & Wrench	Weight (Kg)
BAR1608-32	8-11	8	16	80	32	48	TBET 0601_ _	ST020040 FT-T6	0.08
BAR1610-40	10-13	10	16	87	40	47			0.08
BAR1612-53	12-17	12	16	98	53	45	TPEH 0902_ _	ST025060 FT-T8	0.11
BAR1616-68	16-21	16	16	110	68	42			0.14
BAR1620-83	20-26	20	16	125	83	42	TPEH 1103_ _	ST030070 FT-T10	0.21

Note: When using TP_ _ 0902 carbide inserts, the insert screw hole must be larger than 2.8 mm.

Boring

EFB External Diameter Fine Boring Series

Modular design, for both tool body balancing and machining precision.
 Flexible on tool combination. Easy to use.
 Diameter range \varnothing 25mm - \varnothing 102mm.
 The spindle needs to rotate in anti-clockwise direction while external diameter turning.

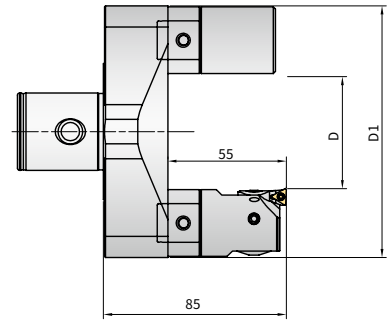

Dia range D	Tool body			Fine boring head		Balance block		Cartridge (Option)	Insert (Option)
	Product code	Weight (Kg)	Coupling size D1	Product code	Weight (Kg)	Product code	Weight (Kg)		
25-34	EFB-025-052-AK6	1.5	118	AFB-032-060-AK3	0.22	EB-AK3	0.22	FCT-30C	TP__ 0802__
34-43								FCT-30B	
43-52								FCT-30A	
50-59								FCT-30C	
59-68	EFB-050-077-AK6	1.8	143					FCT-30B	
68-77								FCT-30A	
75-84								FCT-30C	
84-93	EFB-075-102-AK6	1.9	168					FCT-30B	
93-102								FCT-30A	

Order e.g.: dia 25-34 mm external dia. boring tool, EFB-025-052-AK6 & AFB-032-060-AK3 & EB-AK3.
 dia 34-43 mm external dia. boring tool, EFB-025-052-AK6 & AFB-032-060-AK3-W & FCT-30B & EB-AK3.
 External dia. boring tool is without internal cooling.

EFB External Diameter Fine Boring Series

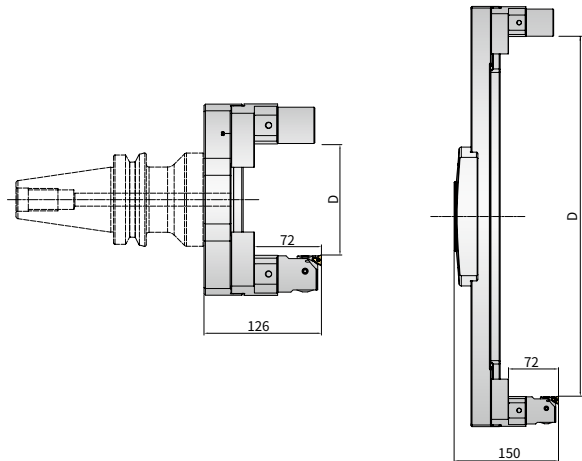

Dia range D	Coupling		Bridge	Slider	Fine boring head	Cartridge	Balance Block	Insert (Option)
	Product code	Weight (Kg)						
41-96	/	/	BS-150-210	EB-150-AK4	AFB-041-074-AK4	FCT-40A	EB-AK4	TC__ 1102__
80-160			BS-210-290					
160-240			BS-290-370					
240-320			BS-370-450					
320-400			BS-450-530					
400-480			BS-530-610					
480-560			BS-610-690					
560-640			BS-690-770					
640-720	BS-770-850							

BT Adaptor for Boring Tools

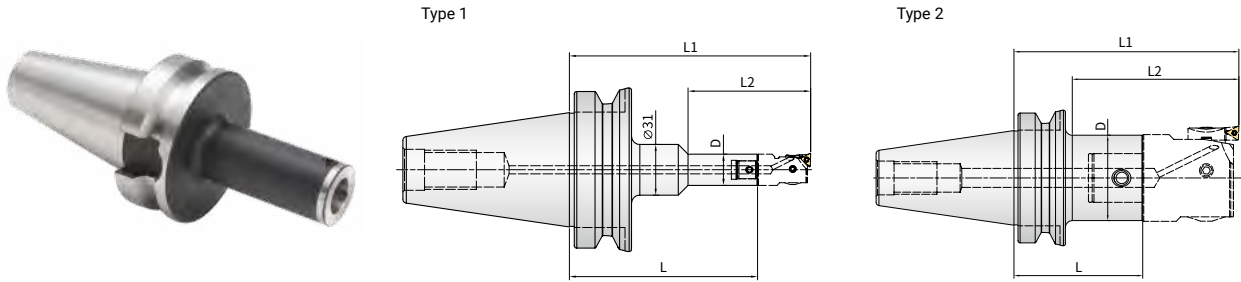

Product code	Coupling	D	L	L1	L2	Weight (Kg)	Type
BT30-AK1-70	AK1	19	70	102	80	0.5	2
BT30-AK2-80	AK2	24	80	115	93	0.6	2
BT30-AK3-80	AK3	31	80	120	98	0.7	2
BT30-AK4-70	AK4	39	70	117	95	0.8	2
BT30-AK5-70	AK5	50	70	127	105	0.8	2
BT30-AK6-70	AK6	64	70	141	119	1.2	2
BT40-AK1-75	AK1	19	75	107	80	1.0	2
BT40-AK1-105	AK1	19	105	137	110	1.2	2
BT40-AK2-85	AK2	24	85	120	93	1.1	2
BT40-AK2-115	AK2	24	115	150	123	1.4	2
BT40-AK3-95	AK3	31	95	135	108	1.2	2
BT40-AK3-125	AK3	31	125	165	138	1.5	2
BT40-AK4-85	AK4	39	85	132	105	1.3	2
BT40-AK4-130	AK4	39	130	177	150	1.9	2
BT40-AK4-175	AK4	39	175	222	195	2.2	2
BT40-AK5-50	AK5	50	50	107	80	1.2	2
BT40-AK5-75	AK5	50	75	132	105	1.3	2
BT40-AK5-125	AK5	50	125	182	155	2.4	2
BT40-AK5-175	AK5	50	175	232	205	3.0	2
BT40-AK6-65	AK6	64	65	136	109	1.3	2
BT40-AK6-115	AK6	64	115	186	159	2.7	2
BT40-AK6-165	AK6	64	165	236	209	3.9	2
BT50-AK1-115	AK1	19	115	147	75	4.0	1
BT50-AK2-85	AK2	24	85	120	82	3.8	2
BT50-AK2-110	AK2	24	110	145	107	3.9	2
BT50-AK3-90	AK3	31	90	130	92	3.9	2
BT50-AK3-125	AK3	31	125	165	127	4.1	2
BT50-AK4-115	AK4	39	115	162	124	4.3	2
BT50-AK4-145	AK4	39	145	192	154	4.5	2
BT50-AK4-175	AK4	39	175	222	184	4.8	2
BT50-AK5-65	AK5	50	65	122	84	3.9	2
BT50-AK5-105	AK5	50	105	162	124	4.5	2
BT50-AK5-150	AK5	50	150	207	169	5.1	2
BT50-AK5-180	AK5	50	180	237	199	5.5	2
BT50-AK5-240	AK5	64	240	297	259	6.2	2
BT50-AK6-95	AK6	64	95	166	128	4.5	2
BT50-AK6-170	AK6	64	170	241	203	6.3	2
BT50-AK6-230	AK6	64	230	301	263	7.7	2
BT50-AK6-290	AK6	64	290	361	323	9.0	2
BT50-AK7-170	AK7	90	170	257	219	6.1	2
BT50-AK7-230	AK7	90	230	317	279	11.8	2
BT50-AK7-290	AK7	90	290	377	339	14.6	2
BT50-AK7-350	AK7	90	350	437	399	17.4	2

Boring

BT Reinforced Adaptor for Boring Tools

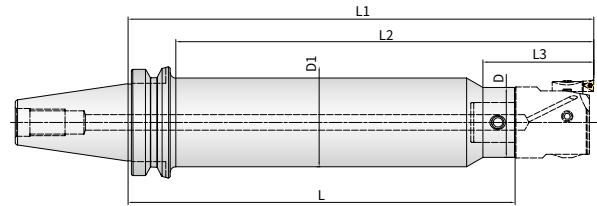

Product code	Coupling	D	D1	L	L1	L2	L3	Weight (Kg)
BT50-AK4-190-P46	AK4	39	46	190	237	194	65	5.6
BT50-AK4-235-P46	AK4	39	46	235	282	239	65	6.2
BT50-AK5-240-P61	AK5	50	61	240	297	254	80	8.2
BT50-AK5-300-P61	AK5	50	61	300	357	314	80	9.6
BT50-AK6-260-P72	AK6	64	72	260	332	289	100	10.3
BT50-AK6-315-P72	AK6	64	72	315	386	343	100	12.2
BT50-AK6-290-P80	AK6	64	80	290	361	318	100	13.2
BT50-AK6-350-P80	AK6	64	80	350	421	378	100	15.2

HSK-A Adaptor for Boring Tools

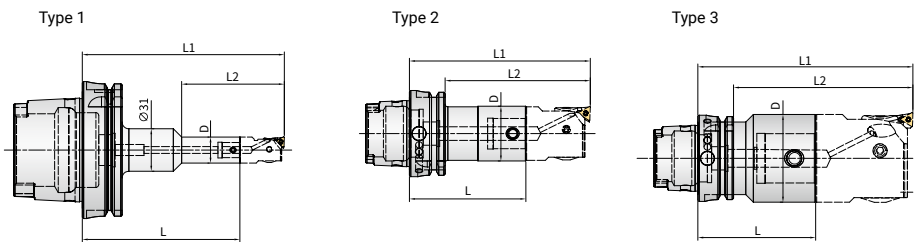

Product code	Coupling	D	L	L1	L2	Weight (Kg)	Type
HSK-A63-AK1-75	AK1	19	75	107	81	0.9	2
HSK-A63-AK1-100	AK1	19	100	132	106	1.3	2
HSK-A63-AK2-85	AK2	24	85	120	94	1.7	2
HSK-A63-AK2-100	AK2	24	100	135	109	2.2	2
HSK-A63-AK3-95	AK3	31	95	135	109	2.3	2
HSK-A63-AK3-125	AK3	31	125	165	139	2.6	2
HSK-A63-AK4-85	AK4	39	85	132	106	2.1	2
HSK-A63-AK4-130	AK4	39	130	177	151	2.7	2
HSK-A63-AK5-75	AK5	50	75	132	106	2.3	2
HSK-A63-AK5-135	AK5	50	135	192	166	2.8	2
HSK-A63-AK6-75	AK6	64	75	146	120	2.3	3
HSK-A63-AK6-115	AK6	64	115	186	160	2.8	3
HSK-A63-AK6-165	AK6	64	165	236	210	3.1	3
HSK-A100-AK1-105	AK1	19	105	137	75	2.6	1
HSK-A100-AK2-115	AK2	24	115	150	121	2.7	2
HSK-A100-AK3-125	AK3	31	125	165	136	2.9	2
HSK-A100-AK4-120	AK4	39	120	167	138	3.1	2
HSK-A100-AK4-180	AK4	39	180	227	198	3.7	2
HSK-A100-AK5-110	AK5	50	110	167	138	3.5	2
HSK-A100-AK5-185	AK5	50	185	242	213	4.6	2
HSK-A100-AK6-95	AK6	64	95	166	137	3.6	2
HSK-A100-AK6-170	AK6	64	170	241	212	5.5	2
HSK-A100-AK6-230	AK6	64	230	301	272	7.1	2

Bridge Boring Adaptor

BT50 bridge boring adaptor

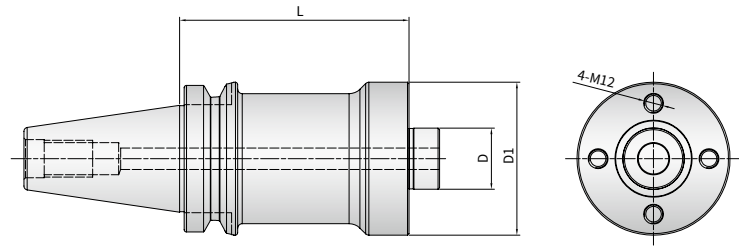

Product code	Coupling	D1	D	L	Screw	Weight (Kg)
BT40-BA40-70	BA40	100	40	70	SH120350	2.8
BT50-BA40-100	BA40	100	40	100		6.1
BT50-BA40-150	BA40	100	40	150		7.9
BT50-BA40-200	BA40	100	40	200		9.7
BT50-BA40-250	BA40	100	40	250		10.9
BT50-BA40-300	BA40	100	40	300		12.5
BT50-BA40-350	BA40	100	40	350		13.9

HSK-A100 Bridge Boring Adaptor



Product code	Coupling	D1	D	L	Screw	Weight (Kg)
HSK-A100-BA40-80	BA40	100	40	80	SH120350	5.1
HSK-A100-BA40-150	BA40	100	40	150		7.3

Extention Adaptor

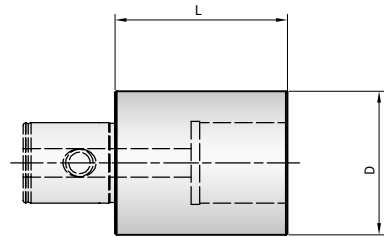

Product code	Back coupling	Front coupling	D	L	Weight (Kg)
AK11-30	AK1	AK1	19	30	0.07
AK22-30	AK2	AK2	24	30	0.10
AK33-30	AK3	AK3	31	30	0.15
AK44-45	AK4	AK4	39	45	0.40
AK44-60	AK4	AK4	39	60	0.53
AK55-60	AK5	AK5	50	60	0.80
AK55-90	AK5	AK5	50	90	1.25
AK66-60	AK6	AK6	64	60	1.40
AK66-100	AK6	AK6	64	100	2.33

Reduction Adaptor

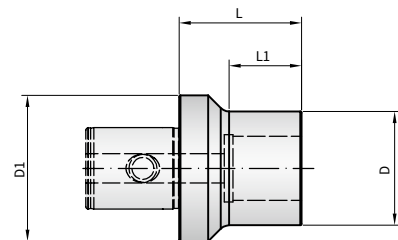

Product code	Back coupling	Front coupling	D1	D	L	L1	Weight (Kg)
AK21-36	AK2	AK1	24	19	36	30	0.10
AK31-41	AK3	AK1	31	19	41	30	0.15
AK32-37	AK3	AK2	31	24	37	25	0.15
AK41-58	AK4	AK1	39	19	58	40	0.30
AK42-50	AK4	AK2	39	24	50	36	0.30
AK43-50	AK4	AK3	39	31	50	37	0.35
AK51-60	AK5	AK1	50	19	60	40	0.45
AK52-54	AK5	AK2	50	24	54	35	0.45
AK52-75	AK5	AK2	50	24	75	55	0.47
AK53-47	AK5	AK3	50	31	47	29	0.50
AK53-75	AK5	AK3	50	31	75	55	0.57
AK54-42	AK5	AK4	50	39	42	25	0.50
AK54-75	AK5	AK4	50	39	75	55	0.66
AK61-70	AK6	AK1	64	19	70	40	0.90
AK62-63	AK6	AK2	64	24	63	45	0.70
AK62-90	AK6	AK2	64	24	90	72	0.72
AK63-56	AK6	AK3	64	31	56	39	0.75
AK63-90	AK6	AK3	64	31	90	73	0.88
AK64-51	AK6	AK4	64	39	51	35	0.85
AK64-90	AK6	AK4	64	39	90	75	1.08
AK65-41	AK6	AK5	64	50	41	25	0.85
AK65-90	AK6	AK5	64	50	90	74	1.45

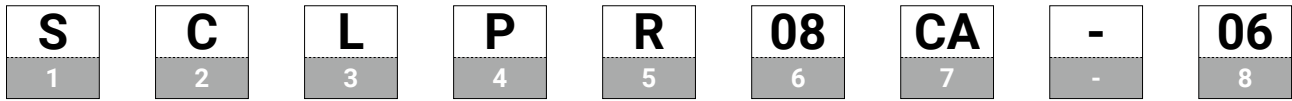

ISO Cartridge Denomination System



1- Insert Clamping Type

S: Screw clamping
M: Top and pin hole clamping

4- Clearance Angle

C:  7° P:  11°

8-Cutting Edge Length

In. circle dimension (mm)	Insert shape							
	C	D	R	S	T	V	W	K
3.97					06		02	
5.0			05					
5.56					09			
6.0		06						
6.35	06	07			11	11	04	
8.0			08					
9.525	09	11	09	09	16	16	06	16
10.0			10					
12.0			12					
12.7	12	15	12	12	22	22	08	
15.875	16		15	15	27			
16.0			16					

2- Insert Shape

C:  80°

5- Cartridge Direction

R: Right hand
L: Left hand

3- Cartridge Type

L  95°

F  90°

G  90°

U  93°

J  93°

R  75°

T  60°

S  45°

6- Height of Cartridge

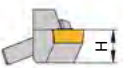
 08=8mm
10=10mm
12=12mm

7- Code of Cartridge

CA--Cartridge

ISO Screw Clamping Cartridge

Kr=95°

SCL.R/L

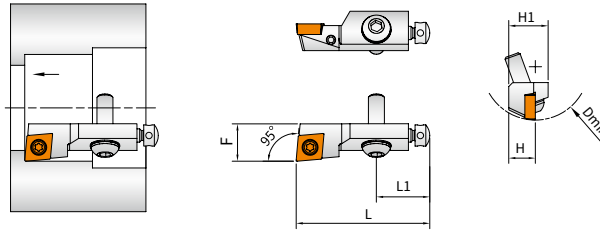

Right-hand	Left-hand	Dimension (mm)						Inserts	R stock	L stock
		H	F	L	H1	L1	Dmin			
SCLCR08CA-06	SCLCL08CA-06	8	10	32	10	17	25	CC_ 0602_	●	●
SCLCR10CA-09	SCLCL10CA-09	10	14	50	15	20	40	CC_ 09T3_	○	○
SCLCR12CA-12	SCLCL12CA-12	12	20	55	20	20	50	CC_ 1204_	○	○
SCLCR16CA-12	SCLCL16CA-12	16	25	63	21	25	60	CC_ 1204_	○	○

● : Stock available ○ : Made to order

Kr=93°

SDJ.R/L

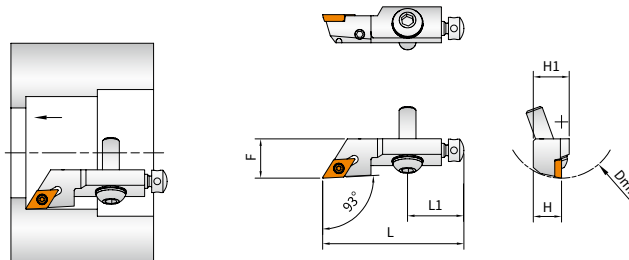

Right-hand	Left-hand	Dimension (mm)						Inserts	R stock	L stock
		H	F	L	H1	L1	Dmin			
SDJCR08CA-07	SDJCL08CA-07	8	14	50	15	20	25	DC_ 0702_	○	○
SDJCR10CA-07	SDJCL10CA-07	10	14	50	15	20	40	DC_ 0702_	●	○
SDJCR10CA-11	SDJCL10CA-11	10	14	50	15	20	40	DC_ 11T3_	○	○
SDJCR12CA-11	SDJCL12CA-11	12	20	55	20	20	50	DC_ 11T3_	○	○

● : Stock available ○ : Made to order

Kr=90°
SCF.R/L

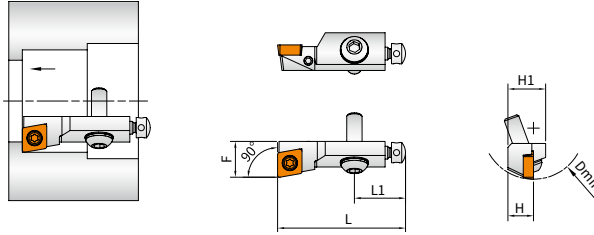

Right-hand	Left-hand	DimensioC(mm)						Inserts	R stock	L stock
		H	F	L	H1	L1	Dmin			
SCFCR08CA-06	SCFCL08CA-06	8	10	32	10	17	25	CC_ 0602__	●	●
SCFCR10CA-06	SCFCL10CA-06	10	14	50	15	20	40	CC_ 0602__	●	●
SCFCR10CA-09	SCFCL10CA-09	10	14	50	15	20	40	CC_ 09T3__	●	●
SCFCR12CA-09	SCFCL12CA-09	12	20	55	20	20	50	CC_ 09T3__	○	○
SCFCR12CA-12	SCFCL12CA-12	12	20	55	20	20	50	CC_ 1204__	●	●
SCFCR16CA-12	SCFCL16CA-12	16	25	63	20	25	60	CC_ 1204__	○	○

● : Stock available ○ : Made to order

Kr=90°
STF.R/L

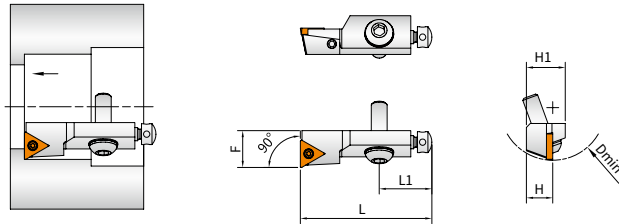

Right-hand	Left-hand	Dimension (mm)						Inserts	R stock	L stock
		H	F	L	H1	L1	Dmin			
STFCR08CA-09	STFCL08CA-09	8	10	32	10	17	25	TC_ 0902__	●	●
STFCR10CA-11	STFCL10CA-11	10	14	50	15	20	40	TC_ 1102__	●	●
STFCR12CA-16	STFCL12CA-16	12	20	55	20	20	50	TC_ 16T3__	●	●
STFCR16CA-16	STFCL16CA-16	16	25	63	21	25	60	TC_ 16T3__	●	●

● : Stock available ○ : Made to order

Kr=75°
SSR.R/L

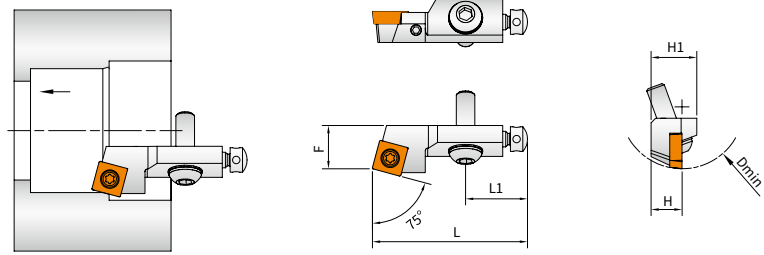

Right-hand	Left-hand	Dimension (mm)						Inserts	R stock	L stock
		H	F	L	H1	L1	Dmin			
SSRCR10CA-09	SSRCL10CA-09	10	14	50	15	20	40	SC__09T3__	●	●
SSRCR12CA-09	SSRCL12CA-09	12	20	55	20	20	50	SC__09T3__	○	○
SSRCR12CA-12	SSRCL12CA-12	12	20	55	20	20	50	SC__1204__	●	●
SSRCR16CA-12	SSRCL16CA-12	16	25	63	21	25	55	SC__1204__	●	●

● : Stock available ○ : Made to order

Kr=60°
SCT.R/L

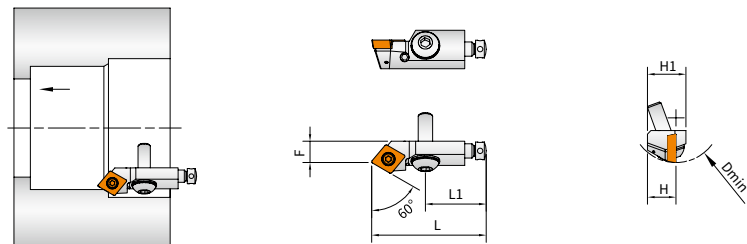

Right-hand	Left-hand	Dimension (mm)						Inserts	R stock	L stock
		H	F	L	H1	L1	Dmin			
SCTCR08CA-06	SCTCL08CA-06	8	6	32	10	17	25	CC__0602__	●	●
SCTCR10CA-09	SCTCL10CA-09	10	9	50	15	20	40	CC__09T3__	●	○

● : Stock available ○ : Made to order

Kr=45°
SCS.R/L

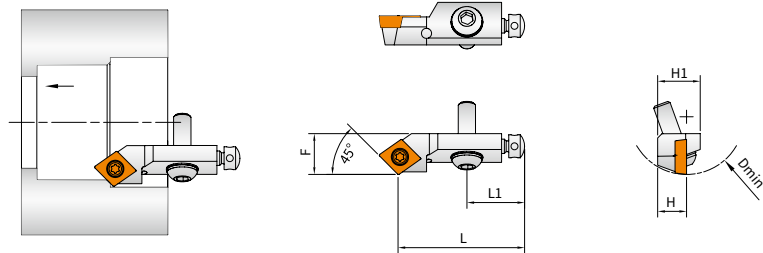

Right-hand	Left-hand	Dimension (mm)						Inserts	R stock	L stock
		H	F	L	H1	L1	Dmin			
SCSCR08CA-06	SCSCL08CA-06	8	10	28	10	17	25	CC_0602_	○	○
SCSCR10CA-09	SCSCL10CA-09	10	14	44	44	20	40	CC_09T3_	○	○

● : Stock available ○ : Made to order

Kr=45°
SSS.R/L

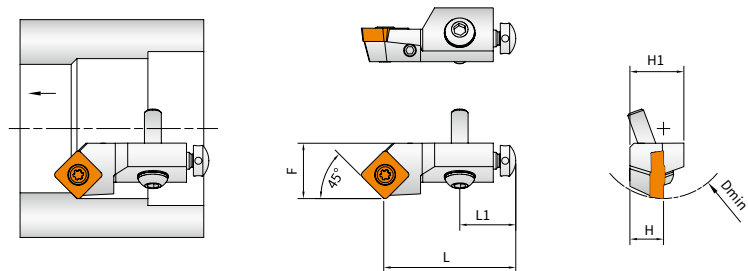

Right-hand	Left-hand	Dimension (mm)						Inserts	R stock	L stock
		H	F	L	H1	L1	Dmin			
SSSCR10CA-09	SSSCL10CA-09	10	14	44	15	20	40	SC_09T3_	●	○
SSSCR12CA-09	SSSCL12CA-09	12	20	47	20	20	50	SC_09T3_	○	○
SSSCR12CA-12	SSSCL12CA-12	12	20	47	20	20	50	SC_1204_	●	○
SSSCR16CA-12	SSSCL16CA-12	16	25	53	21	25	60	SC_1204_	○	○

● : Stock available ○ : Made to order

Boring

Fine Adjustment Cartridge Denomination System

AFB	-	C	90	16	-	C	C	06	R
1	-	2	3	4	-	5	6	7	8

1- Fine Boring Code
AFB--series code
Achteck Fine Boring

3- Approach Angle Kr
90--- Approach angle 90°
95--- Approach angle 95°
120-- Approach angle 120°

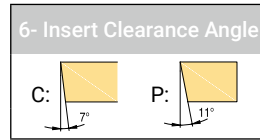
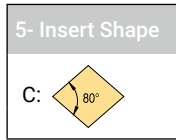

8- Cartridge Direction
R: Right hand
L: Left hand

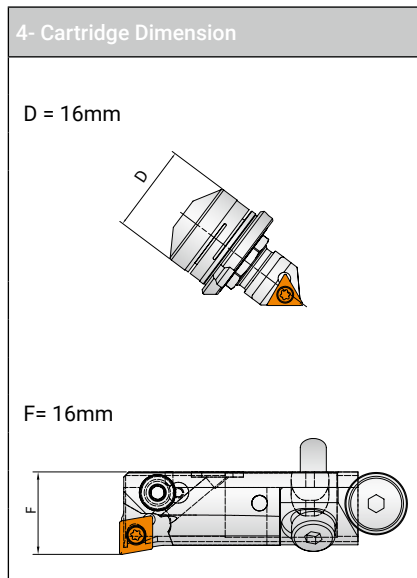
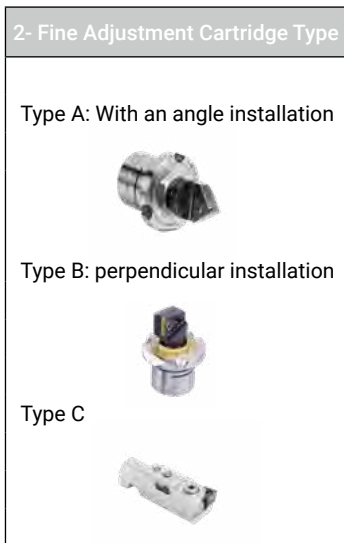

7- Length of Cutting Edge

In.circle dimension (mm)	Insert shape							
	C	D	R	S	T	V	W	K
3.97					06		02	
5.0			05					
5.56					09			
6.0		06						
6.35	06	07			11	11	04	
8.0			08					
9.525	09	11	09	09	16	16	06	16
10.0			10					
12.0			12					
12.7	12	15	12	12	22	22	08	
15.875	16		15	15	27			
16.0			16					

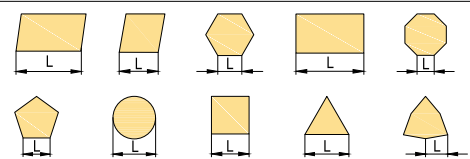

Type A/B Fine Adjustment Cartridge

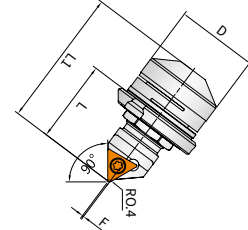
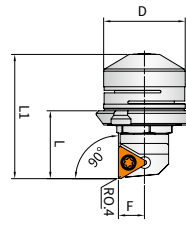

Type A fine adjustment cartridge Type B perpendicular installation Type A installation with an angle

Installation method	Right-hand	Left-hand	Approach angle	Dmin	D	L1	L	F	Insert (Option)	Screw & Wrench
 Installation with an angle	AFB-A9016-CC06R	AFB-A9016-CC06L	90°	25.5	16	25.15	14.3	0.45	CC__0602__	ST025060 FT-T8
	AFB-A9016-TB06R	AFB-A9016-TB06L		24.8	16	25.0	14.3	0.49	TB__0601__	ST020040 FT-T6
	AFB-A9020-TC09R	AFB-A9020-TC09L		32.5	20	33.7	19.1	0.9	TC__0902__	ST022055 FT-T6
	AFB-A9020-TP09R	AFB-A9020-TP09L			20	33.7	19.1	0.9	TP__0902__	ST025060 FT-T8
	AFB-A9022-TC11R	AFB-A9022-TC11L		42.0	22	45.3	23.0	1.1	TC__1102__	ST025060 FT-T8
	AFB-A9022-TP11R	AFB-A9022-TP11L			22	45.3	23.0	1.1	TP__1103__	ST030070 FT-T10
	AFB-A9032-TC16R	AFB-A9032-TC16L		59.5	32	62.3	33.3	1.2	TC__16T3__	ST040100 FT-T15

Installation method	Right-hand	Left-hand	Approach angle	Dmin	D	L1	L	F	Insert (Option)	Screw & Wrench
 Perpendicular installation	AFB-B9016-CC06R	AFB-B9016-CC06L	90°	27.0	16	24.2	13.3	5.1	CC__0602__	ST025060 FT-T8
	AFB-B9016-TB06R	AFB-B9016-TB06L		27.0	16	24.2	13.3	5.1	TB__0601__	ST020040 FT-T6
	AFB-B9020-TC09R	AFB-B9020-TC09L		36.5	20	32.9	18.3	6.3	TC__0902__	ST022055 FT-T6
	AFB-B9020-TP09R	AFB-B9020-TP09L			20	32.9	18.3	6.3	TP__0902__	ST025060 FT-T8
	AFB-B9022-TC11R	AFB-B9022-TC11L		48.5	22	44.3	22.1	7.2	TC__1102__	ST025060 FT-T8
	AFB-B9022-TP11R	AFB-B9022-TP11L			22	44.3	22.1	7.2	TP__1103__	ST030070 FT-T10
	AFB-B9032-TC16R	AFB-B9032-TC16L		68.4	32	62.7	32.0	10.3	TC__16T3__	ST040100 FT-T15

- For cartridge installed in an angle, axial movement = radial movement/tan53°8'
- Never loosen the cartridge beyond the adjustment range indicated by the adjustment wrench, as exceeding the adjustment range may result in damage to the unit.
- Type A/B cartridge is self-locking, so there is no need to unlock it before size adjustment and no need to lock it after adjustment.
- The fine adjustment nut has a dial, and the radial adjustment size is φ0.02mm per minute scale.

Boring

Fine Adjustment Cartridge Instruction

Type A/B fine adjustment cartridge dimension

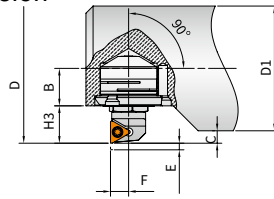

Type B perpendicular installation

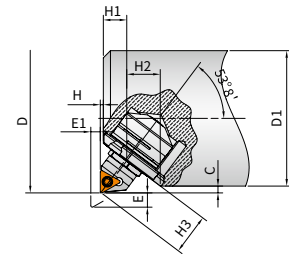

Type A installation with an angle

Installation method	Inserts		D1	D	C	E	E1	H3	H	H1	H2	F
	Product code	R										
 Installation with an angle	CC_06	0.2	22.0	26.2	1.70	2.0	1.5	11.0	0.5	6.6	9.55	0.40
		0.4		25.9	1.65			10.7				0.40
		0.8		25.3	1.60			10.1				0.45
	TB_06	0.2		25.7	1.50			10.9				0.40
		0.4		25.4	1.45			10.6				0.40
		0.8		24.8	1.40			10.0				0.45
	T__09	0.2	28.5	33.4	2.45	2.8	2.1	14.9	9.4	12.15	0.95	
		0.4		33.1	2.30			14.5			1.00	
		0.8		32.5	2.00			13.7			1.10	
	T__11	0.2	38.0	42.9	2.45	4.8	3.6	17.6	11.2	14.85	1.15	
		0.4		42.6	2.30			17.2			1.20	
		0.8		42.0	2.00			16.4			1.30	
	TC_16	0.2	55.0	60.6	2.80	8.0	6.0	26.2	16.65	12.70	1.30	
		0.4		60.0	2.50			25.4			1.40	
		0.8		59.4	2.20			24.6			1.50	

Installation method	Inserts		D1	D	C	E	B	H3	F	
	Product code	R								
 Perpendicular installation	CC_06	0.2	26.0	27.9	0.60	2.5	3.6	9.80	5.1	
		0.4		27.6	0.55			9.60		
		0.8		27.0	0.50			9.10		
	TB_06	0.2		24.0	25.9			0.60		8.80
		0.4			25.6			0.55		8.60
		0.8			25.0			0.50		8.10
	T__09	0.2	34.5	37.4	1.45	3.5	4.55	13.95	6.3	
		0.4		37.1	1.30			13.60		
		0.8		36.5	1.00			12.90		
	T__11	0.2	46.5	49.7	1.45	6.0	7.75	16.75	7.2	
		0.4		49.1	1.30			16.40		
		0.8		48.5	1.00			15.70		
	TC_16	0.2	67.0	69.6	1.30	10.0	9.4	25.00	10.3	
		0.4		69.0	1.00			24.30		
		0.8		68.4	0.70			23.60		

Type C Fine Adjustment Cartridge

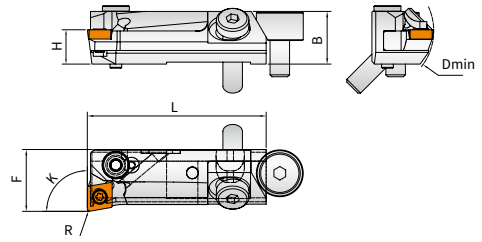

Right hand cartridge

Right-hand	Left-hand	Dmin	L	F	B	H	K	Insert (Option)	Screw & Wrench	
AFB-C9016-CC06R	AFB-C9016-CC06L	28	45.8	16	13.5	8.5	90°	CC__060204	ST025060 FT-T8	
AFB-C9516-CC06R	AFB-C9516-CC06L						95°	CC__060204		
AFB-C9016-TP09R	AFB-C9016-TP09L						90°	TP__090204		
AFB-C9516-TP09R	AFB-C9516-TP09L						95°	TP__090204		
AFB-C12016-DC07R	AFB-C12016-DC07L	28	47.5	16			120°	DC__070204		ST030070 FT-T10
AFB-C9020-TC11R	AFB-C9020-TC11L	36	45.8	20			90°	TC__110204		
AFB-C9520-TC11R	AFB-C9520-TC11L						95°	TC__110204		
AFB-C9020-TP11R	AFB-C9020-TP11L						90°	TP__110304		
AFB-C9520-TP11R	AFB-C9520-TP11L				95°	TP__110304				

- Please read the Type C adjustment instruction before making adjustments to avoid damage to the parts.
- When TP__0902 carbide insert is selected, the hole diameter of the insert screw must be larger than 2.8
- Fine adjustment accuracy is $\varnothing 0.01\text{mm}$ in diameter.
- Axial adjustment movement is 0-1mm; radial adjustment movement is 0- $\varnothing 0.6\text{mm}$

Axial adjustment block	Axial adjustment screw	Cartridge locking screw	Cartridge locking wrench	Radial adjustment wrench	Axial adjustment wrench
ASV-12H	AH050200	SH050200	LT-H4	LT-H2.5	LT-H3



Fine Adjustment Cartridge Instruction

Type C fine adjustment cartridge dimension

Type C cartridge adjustment

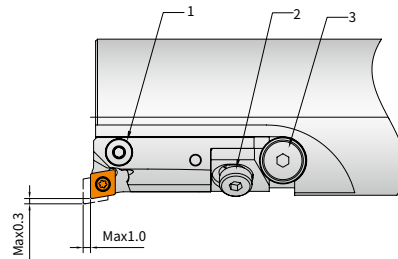
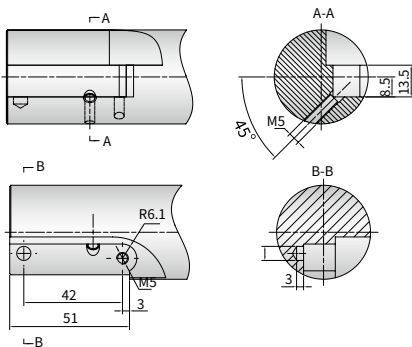

- 1. Radial adjustment screw
- 2. Cartridge set screw
- 3. Axial adjusting screw

Axial adjustment.

- Slightly loosen the cartridge locking screw (position 2 shown)
 - Turn the axial adjustment screw clockwise (position 3 shown); move the cartridge forward to the requested size
- Lock the cartridge screw (position 2 shown)
- Note: If the cartridge needs to be adjusted backward in axial, loosen the cartridge locking screw and move the cartridge to the last position, then adjust the position 3 shown to the requested size

Radial adjustment.

- Turn the radial adjustment screw clockwise (position 1 shown); the tool diameter becomes larger ($\varphi 0.01$ mm per scale)
- Turn the radial adjustment screw counterclockwise (position 1 shown); the tool diameter becomes smaller ($\varphi 0.01$ mm per scale)

Boring Insert

No.	Product code	Workpiece material	Insert grade	Insert type	Stock	
CC__0602__	1	CCMT 060204E-PC2	Steel	AC152P	Coated carbide insert (P05-P15)	●
	2	CCMT 060204E-PC2		AC252P	Coated carbide insert (P20-P35)	●
	3	CCMT 060204E-PC2	Low alloyed steel/ stainless steel	AP301M	Coated carbide insert (M15-M35)	●
	4	CCMT 060204E-KC2	Cast iron	AC102K	Coated carbide insert (K05-K15)	●
				AC202K	Coated carbide insert (K10-K30)	●
	6	CCGW 060204-S01020-SL-1	Aluminium	PB90	CBN insert (K01-K20)	○
	7	CCGT 060204F-NC2		AW100K	Carbide insert	●
	8	CCGW 060204-1-NL-05		PD20	Standard PCD insert	○

	No.	Product code	Workpiece material	Insert grade	Insert type	Stock
CC__ 09T3__	1	CCMT 09T308-M2T	Steel	AT202	Cermet (P10-P20)	●
	2	CCMT 09T308E-PC2		AC152P	Coated carbide insert (P05-P15)	●
	3	CCMT 09T308E-PC2		AC252P	Coated carbide insert (P20-P35)	●
	4	CCMT 09T308E-PC2	Low alloyed steel/ stainless steel	AP301M	Coated carbide insert (M15-M35)	●
	5	CCMT 09T308E-KC2	Cast iron	AC102K	Coated carbide insert (K05-K15)	●
	6	CCMT 09T308E-KC2		AC202K	Coated carbide insert (K10-K30)	●
	7	CCGW 09T308-S01020-SL-1	Aluminium	PB90	CBN (K01-K20)	○
	8	CCGT 09T308F-NC2		AW100K	Carbide insert	●
	9	CCGW 09T308-1-NL-05		PD20	Standard PCD insert	○
	10	CCGW 09T308-1-LL-05		PD20	Straight-edge PCD insert	○

	No.	Product code	Workpiece material	Insert grade	Insert type	Stock
CC__ 1204__	1	CCMT 120408E-PC2	Steel	AT202	Cermet (P10-P20)	●
	2	CCMT 120408E-PC2		AC152P	Coated carbide insert (P05-P15)	●
	3	CCMT 120408E-PC2		AC252P	Coated carbide insert (P20-P35)	●
	4	CCMT 120408E-PC2	Low alloyed steel/ stainless steel	AP301M	Coated carbide insert (M15-M35)	●
	5	CCMT 120408E-KC2	Cast iron	AC102K	Coated carbide insert (K05-K15)	●
	6	CCMT 120408E-KC2		AC202K	Coated carbide insert (K10-K30)	●
	7	CCGW 120408-S01020-SL-1	Aluminium	PB90	CBN (K01-K20)	○
	8	CCGT 120408F-NC2		AW100K	Carbide insert	●
	9	CCGW 120408-1-NL-05		PD20	Standard PCD insert	○

	No.	Product code	Workpiece material	Insert grade	Insert type	Stock
TP__ 0802__	1	TPGT 080204FL-F	Steel	AT200	Cermet (P10-P20)	●
	2	TPEH 080204FL-F	Low alloyed steel/ stainless steel	AP301M	Coated carbide insert (M15-M35)	●
	3	TPGT 080202-1-NL-05	Aluminium	PD20	Standard PCD insert	○
	4	TPGT 080204-1-NL-05		PD20	Standard PCD insert	○

	No.	Product code	Workpiece material	Insert grade	Insert type	Stock
TC__ 1102__	1	TCMT 110204-M2T	Steel	AT202	Cermet (P10-P20)	●
	2	TCGT 110204FL-F		AT200	Cermet (P10-P20)	●
	3	TCMT 110202E-PB1		AC250P	Coated carbide insert (P20-P35)	●
	4	TCMT 110204E-PB1		AC250P	Coated carbide insert (P20-P35)	●
	5	TCGT 110204F-UF	Low alloyed steel/ stainless steel	AP301M	Coated carbide insert (M15-M35)	●
	6	TCGT 110204E-UF		AP301M	Coated carbide insert (M15-M35)	●
	7	TCMT 110204E-KC2	Cast iron	AC202K	Coated carbide insert (K10-K30)	●
	8	TCGT 110204F-NC2	Aluminium	AW100K	Carbide insert	●
	9	TCGW 110202-1-NL-05		PD20	Standard PCD insert	○
	10	TCGW 110204-1-NL-05		PD20	Standard PCD insert	○

●: Available stock ▲: Currently available in stock, but will be replaced by new products in the future

AFB Series Fine Boring Head Operator's Manual

Preparation.

1. Verify that the adjustment range of the fine boring head meets the requirement of the bore diameter to be machined.
2. Check (right figure) that all parts are in order; that the cartridge and insert locking screws are locked tight.
3. Clean and wipe the shank mounting hole and tighten the boring head mounting screw on the shank.
4. Confirm that the assembled boring tool meets the requirement of boring diameter and machining depth.

- Step 1: Loosen the fine adjustment cartridge locking screw ⑦ on the tool change chuck or tool setting gauge.
 Step 2: Rotate the fine adjustment dial ③ to preset to the size needed as indicated .
 Step 3: When preset to the size needed, please make the fine adjustment in the same direction to ensure the fine adjustment accuracy.
 Step 4: Tighten the fine adjustment cartridge locking screw ⑦ with proper force to complete the adjustment.

Fine boring head structure

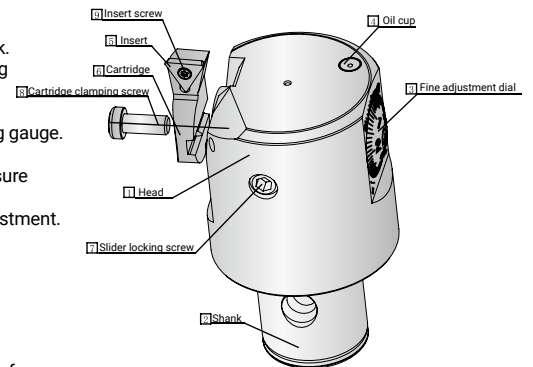

Attention

1. Before machining, make sure all parts are locked properly to avoid damage to the boring head during machining.
2. The AFB series fine boring head rotated its internal precision screw to achieve radial movement of the cartridge. In case of excessive resistance or unable to turn the adjustment dial, stop the operation and check immediately (whether the adjustment cartridge screw is loose or it is out of the adjustment range of the boring head diameter).
3. For reverse boring, use the right-hand insert and reverse rotate the machine spindle, paying attention to the interference range during the movement.
4. For long overhang (> 4 x coupling diameter), it is recommended to use anti-vibration boring tools.
5. Large insert nose radius will help to improve machining safety and surface quality, but may generate vibration. An insert nose radius bigger than 0.4 mm should not be used for finish boring.

ARB Series Rough Boring Head Operator's Manual

Preparation.

1. Verify that the adjustment range of the rough boring head meets the requirement of the bore diameter to be machined.
2. Check (as shown on the right) that all parts are in order; and the cartridge, radial adjustment screw, and insert locking screw are locked to prevent damage to the tool or to avoid cartridge flying out during machining and causing accidents.
3. Confirm that the assembled boring tool meets the requirement for boring diameter and machining depth.
4. Pay attention to the chip removal, cooling, cutting depth and other conditions, and pay attention to the impact of chips to the vibration control.

- Step 1: On the tool change chuck or tool setting gauge, loosen the cartridge screw ⑥ .
 Step 2: Turn the radial adjustment screw ⑦ to reach the required size of the tool.
 Step 3: After adjusting to the size of the tool, lock the cartridge screw ⑥ to complete the adjustment.

Rough boring head main parts name

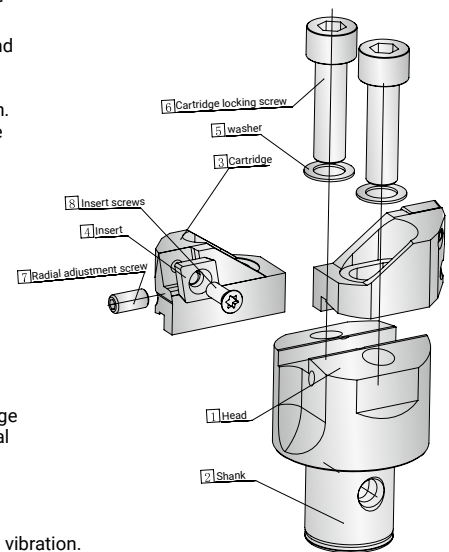

Attention

1. Before machining, ensure that all parts are properly locked to avoid damage to the boring head or prevent the cartridge flying out during machining, which may cause accidents.
2. ARB series rough boring heads are designed for equal radius and balanced machining with double edge cutting; they are used for rough boring with tolerances greater than or equal to IT9 when metal removal rate is a priority.
3. For rough boring with large depth of cut, adequate chip space and chip evacuation condition must be ensured to reduce tool vibration caused by chip jam.
4. For long overhang (> 4 x coupling diameter), it is recommended to use anti-vibration boring tools.
5. A large insert nose radius will help to improve machining safety and surface quality, but may generate vibration. The recommended starting tip nose radius is 0.8 mm.

Bridge boring main parts name

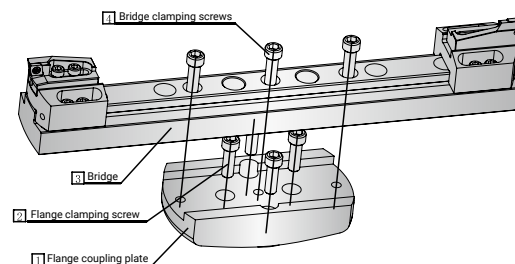
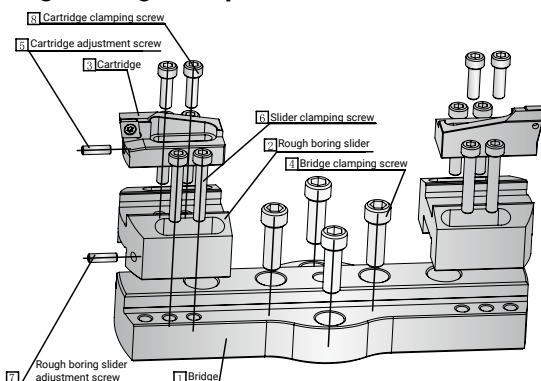

ACHTTECK

www.achtecktool.com/en

THE EXPERT OF DIFFICULT MACHINING



Solid Carbide Drill

Drilling Tool Denomination System

D	1	06	-	03	-	03000	A	1	AP30P1	U
1	2	3	-	4	-	5	6	7	8	9

1-Tool Group	
D	Drilling

2-Generation	
1	

3-Tool Type	
06	Universal
08	Universal

4-Drilling Depth	
03	~3xDc in accordance with DIN 6537K
05	~5xDc in accordance with DIN 6537L
08	~8xDc in accordance with Achteck standard

5-Cutting Diameter	
03000	3.0mm
12100	12.1mm



6-Shank Type	
A	DIN 6535 HA cylindrical shank



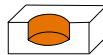

7-Coolant	
0	External coolant
1	Internal coolant

8-Grade	
AP30P1	
Without Mark: grade is not clarified	

9-Application Range	
U	Universal machining P. K. N

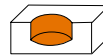
Product Overview

External coolant		
Machining application		
	① Through hole	② Blind hole
Drilling depth	3xDc	5xDc
Series	D106	D106
Standard	DIN 6537 K	DIN 6537 L
Dia. Range(mm)	3~20	3~20
Stock list	P399	P403
		

Internal coolant			
Machining application			
	① Through hole	② Blind hole	
Drilling depth	3xDc	5xDc	8xDc
Series	D106	D106	D108
Standard	DIN 6537 K	DIN 6537 L	Achteck
Dia. Range(mm)	3~16	3~16	3~16
Stock list	P407	P411	P415
			

Solid Carbide Drill D106 with External Coolant 3xDc

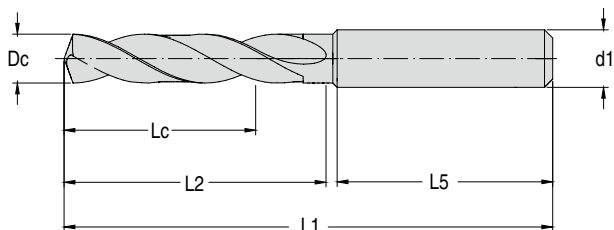

P	M	K	N	S	H
••		••	••		

•• 1st choice ● 2nd choice

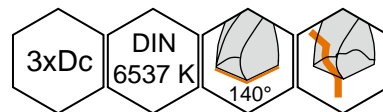

Product code	Dc(m7) mm	Dc inch/No.	Lc mm	L1 mm	L2 mm	L5 mm	d1(h6) mm	stock
D106-03-03000A0 AP30P1U	3		14	62	20	36	4	●
D106-03-03100A0 AP30P1U	3.1		14	62	20	36	4	●
D106-03-03175A0 AP30P1U	3.175	1/8"	14	62	20	36	4	○
D106-03-03200A0 AP30P1U	3.2		14	62	20	36	4	●
D106-03-03250A0 AP30P1U	3.25		14	62	20	36	4	○
D106-03-03300A0 AP30P1U	3.3		14	62	20	36	4	●
D106-03-03400A0 AP30P1U	3.4		14	62	20	36	4	○
D106-03-03500A0 AP30P1U	3.5		14	62	20	36	4	●
D106-03-03572A0 AP30P1U	3.572	9/64"	14	62	20	36	4	○
D106-03-03600A0 AP30P1U	3.6		14	62	20	36	4	●
D106-03-03650A0 AP30P1U	3.65		14	62	20	36	4	○
D106-03-03700A0 AP30P1U	3.7		14	62	20	36	4	●
D106-03-03800A0 AP30P1U	3.8		17	66	24	36	4	○
D106-03-03900A0 AP30P1U	3.9		17	66	24	36	4	●
D106-03-03969A0 AP30P1U	3.969	5/32"	17	66	24	36	4	○
D106-03-04000A0 AP30P1U	4		17	66	24	36	4	●
D106-03-04100A0 AP30P1U	4.1		17	66	24	36	6	○
D106-03-04200A0 AP30P1U	4.2		17	66	24	36	6	●
D106-03-04300A0 AP30P1U	4.3		17	66	24	36	6	○
D106-03-04366A0 AP30P1U	4.366	11/64"	17	66	24	36	6	○
D106-03-04400A0 AP30P1U	4.4		17	66	24	36	6	○
D106-03-04500A0 AP30P1U	4.5		17	66	24	36	6	●
D106-03-04600A0 AP30P1U	4.6		17	66	24	36	6	○
D106-03-04650A0 AP30P1U	4.65		17	66	24	36	6	○
D106-03-04700A0 AP30P1U	4.7		17	66	24	36	6	○
D106-03-04763A0 AP30P1U	4.763	3/16"	20	66	28	36	6	○
D106-03-04800A0 AP30P1U	4.8		20	66	28	36	6	●
D106-03-04900A0 AP30P1U	4.9		20	66	28	36	6	●
D106-03-05000A0 AP30P1U	5		20	66	28	36	6	●
D106-03-05100A0 AP30P1U	5.1		20	66	28	36	6	●
D106-03-05159A0 AP30P1U	5.159	13/64"	20	66	28	36	6	○
D106-03-05200A0 AP30P1U	5.2		20	66	28	36	6	●
D106-03-05300A0 AP30P1U	5.3		20	66	28	36	6	○
D106-03-05400A0 AP30P1U	5.4		20	66	28	36	6	○
D106-03-05500A0 AP30P1U	5.5		20	66	28	36	6	●
D106-03-05550A0 AP30P1U	5.55		20	66	28	36	6	○
D106-03-05556A0 AP30P1U	5.556	7/32"	20	66	28	36	6	○
D106-03-05600A0 AP30P1U	5.6		20	66	28	36	6	○
D106-03-05700A0 AP30P1U	5.7		20	66	28	36	6	○
D106-03-05750A0 AP30P1U	5.75		20	66	28	36	6	○
D106-03-05800A0 AP30P1U	5.8		20	66	28	36	6	●
D106-03-05900A0 AP30P1U	5.9		20	66	28	36	6	●
D106-03-05953A0 AP30P1U	5.953	15/64"	20	66	28	36	6	○
D106-03-06000A0 AP30P1U	6		20	66	28	36	6	●

Special product can be ordered

Marked: ● Stocked ○ Limited-stock

Solid Carbide Drill

Solid Carbide Drill D106 with External Coolant 3xDc

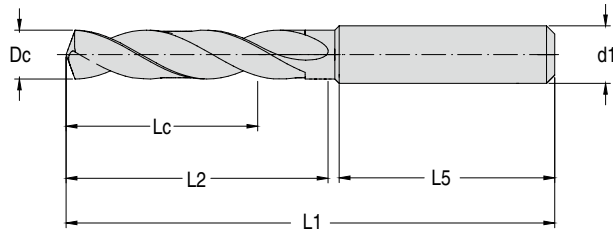

P	M	K	N	S	H
••		••	••		

•• 1st choice • 2nd choice

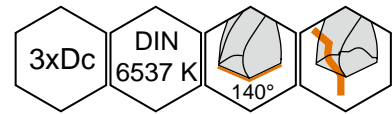

Product code	Dc(m7) mm	Dc inch/No.	Lc mm	L1 mm	L2 mm	L5 mm	d1(h6) mm	stock
D106-03-06100A0 AP30P1U	6.1		24	79	41	36	8	○
D106-03-06200A0 AP30P1U	6.2		24	79	41	36	8	○
D106-03-06300A0 AP30P1U	6.3		24	79	41	36	8	○
D106-03-06350A0 AP30P1U	6.35	1/4"	24	79	41	36	8	○
D106-03-06400A0 AP30P1U	6.4		24	79	41	36	8	○
D106-03-06500A0 AP30P1U	6.5		24	79	41	36	8	●
D106-03-06600A0 AP30P1U	6.6		24	79	41	36	8	○
D106-03-06700A0 AP30P1U	6.7		24	79	41	36	8	○
D106-03-06747A0 AP30P1U	6.747	17/64"	24	79	41	36	8	○
D106-03-06800A0 AP30P1U	6.8		24	79	41	36	8	●
D106-03-06900A0 AP30P1U	6.9		24	79	41	36	8	●
D106-03-07000A0 AP30P1U	7		24	79	41	36	8	●
D106-03-07100A0 AP30P1U	7.1		29	79	41	36	8	○
D106-03-07144A0 AP30P1U	7.144	9/32"	29	79	41	36	8	○
D106-03-07200A0 AP30P1U	7.2		29	79	41	36	8	○
D106-03-07250A0 AP30P1U	7.25		29	79	41	36	8	○
D106-03-07300A0 AP30P1U	7.3		29	79	41	36	8	○
D106-03-07400A0 AP30P1U	7.4		29	79	41	36	8	●
D106-03-07450A0 AP30P1U	7.45		29	79	41	36	8	○
D106-03-07500A0 AP30P1U	7.5		29	79	41	36	8	●
D106-03-07541A0 AP30P1U	7.541	19/64"	29	79	41	36	8	○
D106-03-07550A0 AP30P1U	7.55		29	79	41	36	8	○
D106-03-07600A0 AP30P1U	7.6		29	79	41	36	8	○
D106-03-07700A0 AP30P1U	7.7		29	79	41	36	8	○
D106-03-07800A0 AP30P1U	7.8		29	79	41	36	8	●
D106-03-07900A0 AP30P1U	7.9		29	79	41	36	8	●
D106-03-07938A0 AP30P1U	7.938	5/16"	29	79	41	36	8	○
D106-03-08000A0 AP30P1U	8		29	79	41	36	8	●
D106-03-08100A0 AP30P1U	8.1		35	89	47	40	10	○
D106-03-08200A0 AP30P1U	8.2		35	89	47	40	10	○
D106-03-08300A0 AP30P1U	8.3		35	89	47	40	10	○
D106-03-08334A0 AP30P1U	8.334	21/64"	35	89	47	40	10	○
D106-03-08400A0 AP30P1U	8.4		35	89	47	40	10	○
D106-03-08500A0 AP30P1U	8.5		35	89	47	40	10	●
D106-03-08600A0 AP30P1U	8.6		35	89	47	40	10	●
D106-03-08700A0 AP30P1U	8.7		35	89	47	40	10	○
D106-03-08731A0 AP30P1U	8.731	11/32"	35	89	47	40	10	○
D106-03-08750A0 AP30P1U	8.75		35	89	47	40	10	○
D106-03-08800A0 AP30P1U	8.8		35	89	47	40	10	●
D106-03-08900A0 AP30P1U	8.9		35	89	47	40	10	●
D106-03-09000A0 AP30P1U	9		35	89	47	40	10	●
D106-03-09100A0 AP30P1U	9.1		35	89	47	40	10	○
D106-03-09128A0 AP30P1U	9.128	23/64"	35	89	47	40	10	○
D106-03-09200A0 AP30P1U	9.2		35	89	47	40	10	○
D106-03-09300A0 AP30P1U	9.3		35	89	47	40	10	●
D106-03-09400A0 AP30P1U	9.4		35	89	47	40	10	○
D106-03-09500A0 AP30P1U	9.5		35	89	47	40	10	○
D106-03-09525A0 AP30P1U	9.525	3/8"	35	89	47	40	10	○

Special product can be ordered

Marked: ● Stocked ○ Limited-stock

Solid Carbide Drill D106 with External Coolant 3xDc

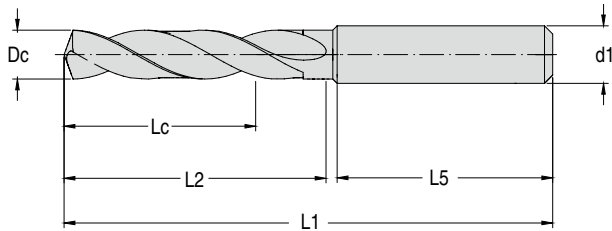

P	M	K	N	S	H
••		••	••		

•• 1st choice ● 2nd choice

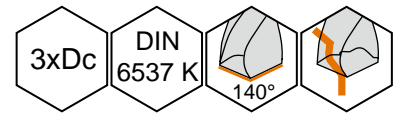

Product code	Dc(m7) mm	Dc inch/No.	Lc mm	L1 mm	L2 mm	L5 mm	d1(h6) mm	stock
D106-03-09550A0 AP30P1U	9.55		35	89	47	40	10	○
D106-03-09600A0 AP30P1U	9.6		35	89	47	40	10	○
D106-03-09700A0 AP30P1U	9.7		35	89	47	40	10	○
D106-03-09800A0 AP30P1U	9.8		35	89	47	40	10	●
D106-03-09900A0 AP30P1U	9.9		35	89	47	40	10	●
D106-03-09922A0 AP30P1U	9.922	25/64"	35	89	47	40	10	○
D106-03-10000A0 AP30P1U	10		35	89	47	40	10	●
D106-03-10100A0 AP30P1U	10.1		40	102	55	45	12	●
D106-03-10200A0 AP30P1U	10.2		40	102	55	45	12	●
D106-03-10300A0 AP30P1U	10.3		40	102	55	45	12	●
D106-03-10319A0 AP30P1U	10.319	13/32"	40	102	55	45	12	○
D106-03-10400A0 AP30P1U	10.4		40	102	55	45	12	○
D106-03-10500A0 AP30P1U	10.5		40	102	55	45	12	●
D106-03-10600A0 AP30P1U	10.6		40	102	55	45	12	●
D106-03-10700A0 AP30P1U	10.7		40	102	55	45	12	○
D106-03-10716A0 AP30P1U	10.716	27/64"	40	102	55	45	12	○
D106-03-10800A0 AP30P1U	10.8		40	102	55	45	12	●
D106-03-10900A0 AP30P1U	10.9		40	102	55	45	12	○
D106-03-11000A0 AP30P1U	11		40	102	55	45	12	●
D106-03-11100A0 AP30P1U	11.1		40	102	55	45	12	○
D106-03-11113A0 AP30P1U	11.113	7/16"	40	102	55	45	12	○
D106-03-11200A0 AP30P1U	11.2		40	102	55	45	12	○
D106-03-11300A0 AP30P1U	11.3		40	102	55	45	12	○
D106-03-11400A0 AP30P1U	11.4		40	102	55	45	12	○
D106-03-11500A0 AP30P1U	11.5		40	102	55	45	12	○
D106-03-11509A0 AP30P1U	11.509	29/64"	40	102	55	45	12	○
D106-03-11550A0 AP30P1U	11.55		40	102	55	45	12	○
D106-03-11600A0 AP30P1U	11.6		40	102	55	45	12	○
D106-03-11700A0 AP30P1U	11.7		40	102	55	45	12	○
D106-03-11800A0 AP30P1U	11.8		40	102	55	45	12	●
D106-03-11900A0 AP30P1U	11.9		40	102	55	45	12	○
D106-03-11906A0 AP30P1U	11.906	15/32"	40	102	55	45	12	○
D106-03-12000A0 AP30P1U	12		40	102	55	45	12	●
D106-03-12100A0 AP30P1U	12.1		43	107	60	45	14	○
D106-03-12200A0 AP30P1U	12.2		43	107	60	45	14	○
D106-03-12250A0 AP30P1U	12.25		43	107	60	45	14	○
D106-03-12300A0 AP30P1U	12.3		43	107	60	45	14	○
D106-03-12303A0 AP30P1U	12.303	31/64"	43	107	60	45	14	○
D106-03-12400A0 AP30P1U	12.4		43	107	60	45	14	○
D106-03-12500A0 AP30P1U	12.5		43	107	60	45	14	●
D106-03-12600A0 AP30P1U	12.6		43	107	60	45	14	○
D106-03-12700A0 AP30P1U	12.7	1/2"	43	107	60	45	14	○
D106-03-12750A0 AP30P1U	12.75		43	107	60	45	14	○
D106-03-12800A0 AP30P1U	12.8		43	107	60	45	14	○

Special product can be ordered

Marked: ● Stocked ○ Limited-stock

Solid Carbide Drill

Solid Carbide Drill D106 with External Coolant 3xDc

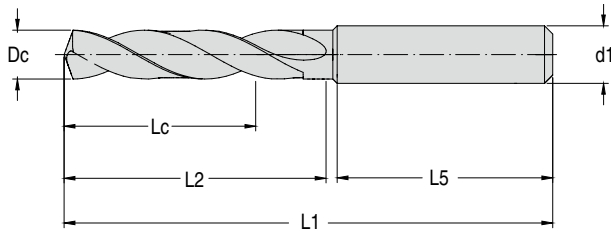

P	M	K	N	S	H
••		••	••		

● 1st choice ● 2nd choice

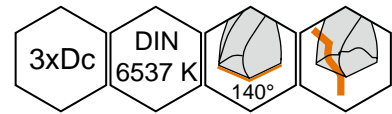

Product code	Dc(m7) mm	Dc inch/No.	Lc mm	L1 mm	L2 mm	L5 mm	d1(h6) mm	stock
D106-03-12900A0 AP30P1U	12.9		43	107	60	45	14	○
D106-03-13000A0 AP30P1U	13		43	107	60	45	14	●
D106-03-13100A0 AP30P1U	13.1		43	107	60	45	14	○
D106-03-13200A0 AP30P1U	13.2		43	107	60	45	14	●
D106-03-13300A0 AP30P1U	13.3		43	107	60	45	14	○
D106-03-13400A0 AP30P1U	13.4		43	107	60	45	14	○
D106-03-13494A0 AP30P1U	13.494	17/32"	43	107	60	45	14	○
D106-03-13500A0 AP30P1U	13.5		43	107	60	45	14	○
D106-03-13600A0 AP30P1U	13.6		43	107	60	45	14	○
D106-03-13700A0 AP30P1U	13.7		43	107	60	45	14	○
D106-03-13800A0 AP30P1U	13.8		43	107	60	45	14	○
D106-03-13900A0 AP30P1U	13.9		43	107	60	45	14	○
D106-03-14000A0 AP30P1U	14		43	107	60	45	14	●
D106-03-14100A0 AP30P1U	14.1		45	115	65	48	16	●
D106-03-14200A0 AP30P1U	14.2		45	115	65	48	16	●
D106-03-14288A0 AP30P1U	14.288	9/16"	45	115	65	48	16	○
D106-03-14300A0 AP30P1U	14.3		45	115	65	48	16	○
D106-03-14400A0 AP30P1U	14.4		45	115	65	48	16	○
D106-03-14500A0 AP30P1U	14.5		45	115	65	48	16	●
D106-03-14600A0 AP30P1U	14.6		45	115	65	48	16	●
D106-03-14700A0 AP30P1U	14.7		45	115	65	48	16	●
D106-03-14750A0 AP30P1U	14.75		45	115	65	48	16	○
D106-03-14800A0 AP30P1U	14.8		45	115	65	48	16	○
D106-03-15000A0 AP30P1U	15		45	115	65	48	16	●
D106-03-15100A0 AP30P1U	15.1		45	115	65	48	16	○
D106-03-15200A0 AP30P1U	15.2		45	115	65	48	16	○
D106-03-15300A0 AP30P1U	15.3		45	115	65	48	16	○
D106-03-15500A0 AP30P1U	15.5		45	115	65	48	16	●
D106-03-15600A0 AP30P1U	15.6		45	115	65	48	16	○
D106-03-15700A0 AP30P1U	15.7		45	115	65	48	16	●
D106-03-15800A0 AP30P1U	15.8		45	115	65	48	16	●
D106-03-15875A0 AP30P1U	15.875	5/8"	45	115	65	48	16	○
D106-03-15900A0 AP30P1U	15.9		45	115	65	48	16	○
D106-03-16000A0 AP30P1U	16		45	115	65	48	16	●
D106-03-16500A0 AP30P1U	16.5		51	123	73	48	18	●
D106-03-17000A0 AP30P1U	17		51	123	73	48	18	●
D106-03-17500A0 AP30P1U	17.5		51	123	73	48	18	●
D106-03-18000A0 AP30P1U	18		51	123	73	48	18	●
D106-03-18500A0 AP30P1U	18.5		55	131	79	50	20	●
D106-03-19000A0 AP30P1U	19		55	131	79	50	20	●
D106-03-20000A0 AP30P1U	20		55	131	79	50	20	●

Special product can be ordered

Marked: ● Stocked ○ Limited-stock

Solid Carbide Drill D106 with External Coolant 5xDc

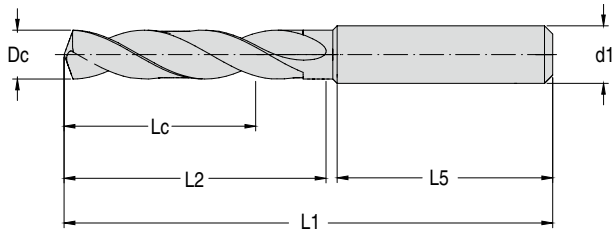

P	M	K	N	S	H
••		••	••		

•• 1st choice • 2nd choice

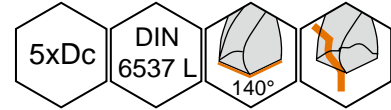

Product code	Dc(m7) mm	Dc inch/No.	Lc mm	L1 mm	L2 mm	L5 mm	d1(h6) mm	stock
D106-05-03000A0 AP30P1U	3		23	66	28	36	4	●
D106-05-03100A0 AP30P1U	3.1		23	66	28	36	4	●
D106-05-03175A0 AP30P1U	3.175	1/8"	23	66	28	36	4	○
D106-05-03200A0 AP30P1U	3.2		23	66	28	36	4	●
D106-05-03250A0 AP30P1U	3.25		23	66	28	36	4	○
D106-05-03300A0 AP30P1U	3.3		23	66	28	36	4	●
D106-05-03400A0 AP30P1U	3.4		23	66	28	36	4	○
D106-05-03500A0 AP30P1U	3.5		23	66	28	36	4	●
D106-05-03572A0 AP30P1U	3.572	9/64"	23	66	28	36	4	○
D106-05-03600A0 AP30P1U	3.6		23	66	28	36	4	●
D106-05-03650A0 AP30P1U	3.65		23	66	28	36	4	○
D106-05-03700A0 AP30P1U	3.7		23	66	28	36	4	●
D106-05-03800A0 AP30P1U	3.8		29	74	36	36	4	○
D106-05-03900A0 AP30P1U	3.9		29	74	36	36	4	●
D106-05-03969A0 AP30P1U	3.969	5/32"	29	74	36	36	4	○
D106-05-04000A0 AP30P1U	4		29	74	36	36	4	●
D106-05-04100A0 AP30P1U	4.1		29	74	36	36	6	○
D106-05-04200A0 AP30P1U	4.2		29	74	36	36	6	●
D106-05-04300A0 AP30P1U	4.3		29	74	36	36	6	○
D106-05-04366A0 AP30P1U	4.366	11/64"	29	74	36	36	6	○
D106-05-04400A0 AP30P1U	4.4		29	74	36	36	6	○
D106-05-04500A0 AP30P1U	4.5		29	74	36	36	6	●
D106-05-04600A0 AP30P1U	4.6		29	74	36	36	6	○
D106-05-04650A0 AP30P1U	4.65		29	74	36	36	6	○
D106-05-04700A0 AP30P1U	4.7		29	74	36	36	6	○
D106-05-04763A0 AP30P1U	4.763	3/16"	35	82	44	36	6	○
D106-05-04800A0 AP30P1U	4.8		35	82	44	36	6	●
D106-05-04900A0 AP30P1U	4.9		35	82	44	36	6	●
D106-05-05000A0 AP30P1U	5		35	82	44	36	6	●
D106-05-05100A0 AP30P1U	5.1		35	82	44	36	6	●
D106-05-05159A0 AP30P1U	5.159	13/64"	35	82	44	36	6	○
D106-05-05200A0 AP30P1U	5.2		35	82	44	36	6	●
D106-05-05300A0 AP30P1U	5.3		35	82	44	36	6	○
D106-05-05400A0 AP30P1U	5.4		35	82	44	36	6	○
D106-05-05500A0 AP30P1U	5.5		35	82	44	36	6	●
D106-05-05550A0 AP30P1U	5.55		35	82	44	36	6	○
D106-05-05556A0 AP30P1U	5.556	7/32"	35	82	44	36	6	○
D106-05-05600A0 AP30P1U	5.6		35	82	44	36	6	○
D106-05-05700A0 AP30P1U	5.7		35	82	44	36	6	○
D106-05-05800A0 AP30P1U	5.8		35	82	44	36	6	●
D106-05-05900A0 AP30P1U	5.9		35	82	44	36	6	●
D106-05-05953A0 AP30P1U	5.953	15/64"	35	82	44	36	6	○
D106-05-06000A0 AP30P1U	6		35	82	44	36	6	●
D106-05-06100A0 AP30P1U	6.1		43	91	53	36	8	○

Special product can be ordered

Marked: ● Stocked ○ Limited-stock

Solid Carbide Drill

Solid Carbide Drill D106 with External Coolant 5xDc

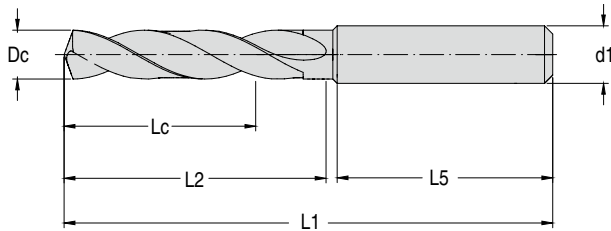

P	M	K	N	S	H
••		••	••		

•• 1st choice ● 2nd choice

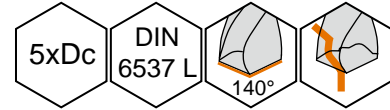

Product code	Dc(m7) mm	Dc inch/No.	Lc mm	L1 mm	L2 mm	L5 mm	d1(h6) mm	stock
D106-05-06200A0 AP30P1U	6.2		43	91	53	36	8	○
D106-05-06300A0 AP30P1U	6.3		43	91	53	36	8	○
D106-05-06350A0 AP30P1U	6.35	1/4"	43	91	53	36	8	○
D106-05-06400A0 AP30P1U	6.4		43	91	53	36	8	○
D106-05-06500A0 AP30P1U	6.5		43	91	53	36	8	●
D106-05-06600A0 AP30P1U	6.6		43	91	53	36	8	○
D106-05-06700A0 AP30P1U	6.7		43	91	53	36	8	○
D106-05-06747A0 AP30P1U	6.747	17/64"	43	91	53	36	8	○
D106-05-06800A0 AP30P1U	6.8		43	91	53	36	8	●
D106-05-06900A0 AP30P1U	6.9		43	91	53	36	8	●
D106-05-07000A0 AP30P1U	7		43	91	53	36	8	●
D106-05-07100A0 AP30P1U	7.1		43	91	53	36	8	○
D106-05-07144A0 AP30P1U	7.144	9/32"	43	91	53	36	8	○
D106-05-07200A0 AP30P1U	7.2		43	91	53	36	8	○
D106-05-07300A0 AP30P1U	7.3		43	91	53	36	8	○
D106-05-07400A0 AP30P1U	7.4		43	91	53	36	8	●
D106-05-07500A0 AP30P1U	7.5		43	91	53	36	8	●
D106-05-07541A0 AP30P1U	7.541	19/64"	43	91	53	36	8	○
D106-05-07550A0 AP30P1U	7.55		43	91	53	36	8	○
D106-05-07600A0 AP30P1U	7.6		43	91	53	36	8	○
D106-05-07700A0 AP30P1U	7.7		43	91	53	36	8	○
D106-05-07800A0 AP30P1U	7.8		43	91	53	36	8	●
D106-05-07900A0 AP30P1U	7.9		43	91	53	36	8	●
D106-05-07938A0 AP30P1U	7.938	5/16"	43	91	53	36	8	○
D106-05-08000A0 AP30P1U	8		43	91	53	36	8	●
D106-05-08100A0 AP30P1U	8.1		49	103	61	40	10	○
D106-05-08200A0 AP30P1U	8.2		49	103	61	40	10	○
D106-05-08300A0 AP30P1U	8.3		49	103	61	40	10	○
D106-05-08334A0 AP30P1U	8.334	21/64"	49	103	61	40	10	○
D106-05-08400A0 AP30P1U	8.4		49	103	61	40	10	○
D106-05-08500A0 AP30P1U	8.5		49	103	61	40	10	●
D106-05-08600A0 AP30P1U	8.6		49	103	61	40	10	●
D106-05-08700A0 AP30P1U	8.7		49	103	61	40	10	○
D106-05-08731A0 AP30P1U	8.731	11/32"	49	103	61	40	10	○
D106-05-08800A0 AP30P1U	8.8		49	103	61	40	10	●
D106-05-08900A0 AP30P1U	8.9		49	103	61	40	10	●
D106-05-09000A0 AP30P1U	9		49	103	61	40	10	●
D106-05-09100A0 AP30P1U	9.1		49	103	61	40	10	○
D106-05-09128A0 AP30P1U	9.128	23/64"	49	103	61	40	10	○
D106-05-09200A0 AP30P1U	9.2		49	103	61	40	10	○
D106-05-09300A0 AP30P1U	9.3		49	103	61	40	10	●
D106-05-09400A0 AP30P1U	9.4		49	103	61	40	10	○
D106-05-09500A0 AP30P1U	9.5		49	103	61	40	10	○
D106-05-09525A0 AP30P1U	9.525	3/8"	49	103	61	40	10	○

Special product can be ordered

Marked: ● Stocked ○ Limited-stock

Solid Carbide Drill D106 with External Coolant 5xDc

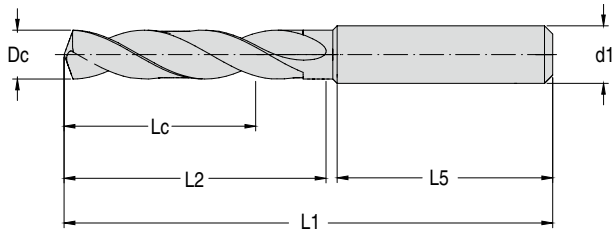

P	M	K	N	S	H
••		••	••		

•• 1st choice • 2nd choice

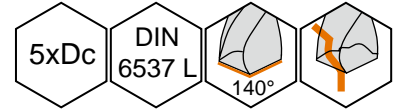

Product code	Dc(m7) mm	Dc inch/No.	Lc mm	L1 mm	L2 mm	L5 mm	d1(h6) mm	stock
D106-05-09550A0 AP30P1U	9.55		49	103	61	40	10	○
D106-05-09600A0 AP30P1U	9.6		49	103	61	40	10	○
D106-05-09700A0 AP30P1U	9.7		49	103	61	40	10	○
D106-05-09800A0 AP30P1U	9.8		49	103	61	40	10	●
D106-05-09900A0 AP30P1U	9.9		49	103	61	40	10	●
D106-05-09922A0 AP30P1U	9.922	25/64"	49	103	61	40	10	○
D106-05-10000A0 AP30P1U	10		49	103	61	40	10	●
D106-05-10100A0 AP30P1U	10.1		56	118	71	45	12	●
D106-05-10200A0 AP30P1U	10.2		56	118	71	45	12	●
D106-05-10300A0 AP30P1U	10.3		56	118	71	45	12	●
D106-05-10319A0 AP30P1U	10.319	13/32"	56	118	71	45	12	○
D106-05-10400A0 AP30P1U	10.4		56	118	71	45	12	○
D106-05-10500A0 AP30P1U	10.5		56	118	71	45	12	●
D106-05-10600A0 AP30P1U	10.6		56	118	71	45	12	●
D106-05-10700A0 AP30P1U	10.7		56	118	71	45	12	○
D106-05-10716A0 AP30P1U	10.716	27/64"	56	118	71	45	12	○
D106-05-10800A0 AP30P1U	10.8		56	118	71	45	12	●
D106-05-10900A0 AP30P1U	10.9		56	118	71	45	12	○
D106-05-11000A0 AP30P1U	11		56	118	71	45	12	●
D106-05-11100A0 AP30P1U	11.1		56	118	71	45	12	○
D106-05-11113A0 AP30P1U	11.113	7/16"	56	118	71	45	12	○
D106-05-11200A0 AP30P1U	11.2		56	118	71	45	12	○
D106-05-11300A0 AP30P1U	11.3		56	118	71	45	12	○
D106-05-11400A0 AP30P1U	11.4		56	118	71	45	12	○
D106-05-11500A0 AP30P1U	11.5		56	118	71	45	12	○
D106-05-11509A0 AP30P1U	11.509	29/64"	56	118	71	45	12	○
D106-05-11550A0 AP30P1U	11.55		56	118	71	45	12	○
D106-05-11600A0 AP30P1U	11.6		56	118	71	45	12	○
D106-05-11700A0 AP30P1U	11.7		56	118	71	45	12	○
D106-05-11800A0 AP30P1U	11.8		56	118	71	45	12	●
D106-05-11900A0 AP30P1U	11.9		56	118	71	45	12	○
D106-05-11906A0 AP30P1U	11.906	15/32"	56	118	71	45	12	○
D106-05-12000A0 AP30P1U	12		56	118	71	45	12	●
D106-05-12100A0 AP30P1U	12.1		60	124	77	45	14	○
D106-05-12200A0 AP30P1U	12.2		60	124	77	45	14	○
D106-05-12250A0 AP30P1U	12.25		60	124	77	45	14	○
D106-05-12300A0 AP30P1U	12.3		60	124	77	45	14	○
D106-05-12303A0 AP30P1U	12.303	31/64"	60	124	77	45	14	○
D106-05-12400A0 AP30P1U	12.4		60	124	77	45	14	○
D106-05-12500A0 AP30P1U	12.5		60	124	77	45	14	●
D106-05-12600A0 AP30P1U	12.6		60	124	77	45	14	○
D106-05-12700A0 AP30P1U	12.7	1/2"	60	124	77	45	14	○
D106-05-12750A0 AP30P1U	12.75		60	124	77	45	14	○
D106-05-12800A0 AP30P1U	12.8		60	124	77	45	14	○

Special product can be ordered

Marked: ● Stocked ○ Limited-stock

Solid Carbide Drill

Solid Carbide Drill D106 with External Coolant 5xDc

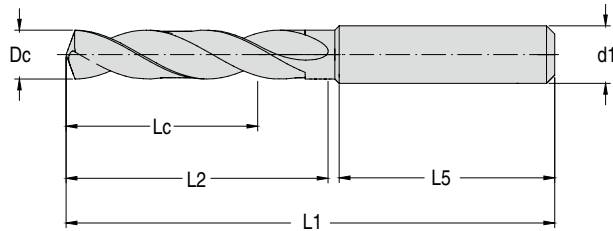

P	M	K	N	S	H
••		••	••		

•• 1st choice ● 2nd choice

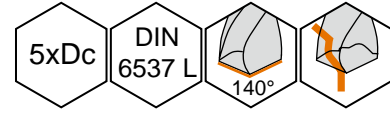

Product code	Dc(m7) mm	Dc inch/No.	Lc mm	L1 mm	L2 mm	L5 mm	d1(h6) mm	stock
D106-05-12900A0 AP30P1U	12.9		60	124	77	45	14	○
D106-05-13000A0 AP30P1U	13		60	124	77	45	14	●
D106-05-13100A0 AP30P1U	13.1		60	124	77	45	14	○
D106-05-13200A0 AP30P1U	13.2		60	124	77	45	14	●
D106-05-13300A0 AP30P1U	13.3		60	124	77	45	14	○
D106-05-13400A0 AP30P1U	13.4		60	124	77	45	14	○
D106-05-13494A0 AP30P1U	13.494	17/32"	60	124	77	45	14	○
D106-05-13500A0 AP30P1U	13.5		60	124	77	45	14	○
D106-05-13600A0 AP30P1U	13.6		60	124	77	45	14	○
D106-05-13700A0 AP30P1U	13.7		60	124	77	45	14	●
D106-05-13800A0 AP30P1U	13.8		60	124	77	45	14	○
D106-05-13900A0 AP30P1U	13.9		60	124	77	45	14	○
D106-05-14000A0 AP30P1U	14		60	124	77	45	14	●
D106-05-14100A0 AP30P1U	14.1		63	133	83	48	16	●
D106-05-14200A0 AP30P1U	14.2		63	133	83	48	16	●
D106-05-14288A0 AP30P1U	14.288	9/16"	63	133	83	48	16	○
D106-05-14300A0 AP30P1U	14.3		63	133	83	48	16	○
D106-05-14400A0 AP30P1U	14.4		63	133	83	48	16	○
D106-05-14500A0 AP30P1U	14.5		63	133	83	48	16	●
D106-05-14600A0 AP30P1U	14.6		63	133	83	48	16	●
D106-05-14700A0 AP30P1U	14.7		63	133	83	48	16	●
D106-05-14750A0 AP30P1U	14.75		63	133	83	48	16	○
D106-05-14800A0 AP30P1U	14.8		63	133	83	48	16	○
D106-05-15000A0 AP30P1U	15		63	133	83	48	16	●
D106-05-15100A0 AP30P1U	15.1		63	133	83	48	16	○
D106-05-15200A0 AP30P1U	15.2		63	133	83	48	16	○
D106-05-15300A0 AP30P1U	15.3		63	133	83	48	16	○
D106-05-15500A0 AP30P1U	15.5		63	133	83	48	16	●
D106-05-15600A0 AP30P1U	15.6		63	133	83	48	16	○
D106-05-15700A0 AP30P1U	15.7		63	133	83	48	16	●
D106-05-15800A0 AP30P1U	15.8		63	133	83	48	16	●
D106-05-15875A0 AP30P1U	15.875	5/8"	63	133	83	48	16	○
D106-05-15900A0 AP30P1U	15.9		63	133	83	48	16	○
D106-05-16000A0 AP30P1U	16		63	133	83	48	16	●
D106-05-16500A0 AP30P1U	16.5		71	143	93	48	18	●
D106-05-17000A0 AP30P1U	17		71	143	93	48	18	●
D106-05-17500A0 AP30P1U	17.5		71	143	93	48	18	●
D106-05-18000A0 AP30P1U	18		71	143	93	48	18	●
D106-05-18500A0 AP30P1U	18.5		77	153	101	50	20	●
D106-05-19000A0 AP30P1U	19		77	153	101	50	20	●
D106-05-20000A0 AP30P1U	20		77	153	101	50	20	●

Special product can be ordered

Marked: ● Stocked ○ Limited-stock

Solid Carbide Drill D106 with Internal Coolant 3xDc

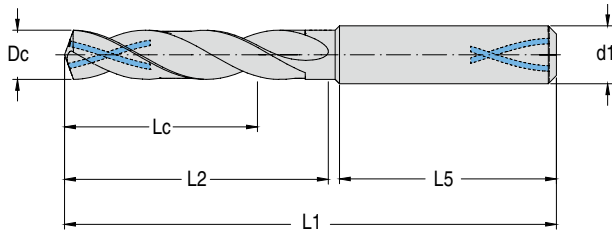

P	M	K	N	S	H
••	•	••	••	•	•

● 1st choice ● 2nd choice

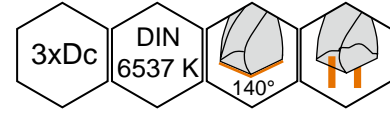

Product code	Dc(m7) mm	Dc inch/No.	Lc mm	L1 mm	L2 mm	L5 mm	d1(h6) mm	stock
D106-03-03000A1 AP30P1U	3		14	62	20	36	4	●
D106-03-03100A1 AP30P1U	3.1		14	62	20	36	4	●
D106-03-03175A1 AP30P1U	3.175	1/8"	14	62	20	36	4	○
D106-03-03200A1 AP30P1U	3.2		14	62	20	36	4	●
D106-03-03250A1 AP30P1U	3.25		14	62	20	36	4	○
D106-03-03300A1 AP30P1U	3.3		14	62	20	36	4	●
D106-03-03400A1 AP30P1U	3.4		14	62	20	36	4	○
D106-03-03500A1 AP30P1U	3.5		14	62	20	36	4	●
D106-03-03572A1 AP30P1U	3.572	9/64"	14	62	20	36	4	○
D106-03-03600A1 AP30P1U	3.6		14	62	20	36	4	●
D106-03-03650A1 AP30P1U	3.65		14	62	20	36	4	○
D106-03-03700A1 AP30P1U	3.7		14	62	20	36	4	●
D106-03-03800A1 AP30P1U	3.8		17	66	24	36	4	○
D106-03-03900A1 AP30P1U	3.9		17	66	24	36	4	●
D106-03-03969A1 AP30P1U	3.969	5/32"	17	66	24	36	4	○
D106-03-04000A1 AP30P1U	4		17	66	24	36	4	●
D106-03-04100A1 AP30P1U	4.1		17	66	24	36	6	○
D106-03-04200A1 AP30P1U	4.2		17	66	24	36	6	●
D106-03-04300A1 AP30P1U	4.3		17	66	24	36	6	○
D106-03-04366A1 AP30P1U	4.366	11/64"	17	66	24	36	6	○
D106-03-04400A1 AP30P1U	4.4		17	66	24	36	6	○
D106-03-04500A1 AP30P1U	4.5		17	66	24	36	6	●
D106-03-04600A1 AP30P1U	4.6		17	66	24	36	6	○
D106-03-04650A1 AP30P1U	4.65		17	66	24	36	6	○
D106-03-04700A1 AP30P1U	4.7		17	66	24	36	6	○
D106-03-04763A1 AP30P1U	4.763	3/16"	20	66	28	36	6	○
D106-03-04800A1 AP30P1U	4.8		20	66	28	36	6	●
D106-03-04900A1 AP30P1U	4.9		20	66	28	36	6	●
D106-03-05000A1 AP30P1U	5		20	66	28	36	6	●
D106-03-05100A1 AP30P1U	5.1		20	66	28	36	6	●
D106-03-05159A1 AP30P1U	5.159	13/64"	20	66	28	36	6	○
D106-03-05200A1 AP30P1U	5.2		20	66	28	36	6	●
D106-03-05300A1 AP30P1U	5.3		20	66	28	36	6	○
D106-03-05400A1 AP30P1U	5.4		20	66	28	36	6	○
D106-03-05500A1 AP30P1U	5.5		20	66	28	36	6	●
D106-03-05550A1 AP30P1U	5.55		20	66	28	36	6	○

Special product can be ordered

Marked: ● Stocked ○ Limited-stock

Solid Carbide Drill

Solid Carbide Drill D106 with Internal Coolant 3xDc

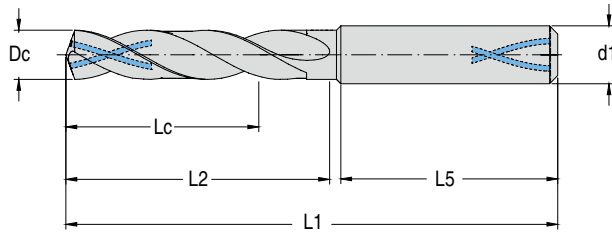

P	M	K	N	S	H
••	•	••	••	•	•

● 1st choice ● 2nd choice

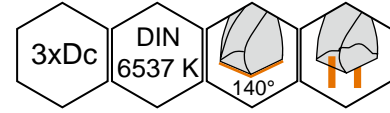

Product code	Dc(m7) mm	Dc inch/No.	Lc mm	L1 mm	L2 mm	L5 mm	d1(h6) mm	stock
D106-03-05556A1 AP30P1U	5.556	7/32"	20	66	28	36	6	○
D106-03-05600A1 AP30P1U	5.6		20	66	28	36	6	○
D106-03-05700A1 AP30P1U	5.7		20	66	28	36	6	○
D106-03-05750A1 AP30P1U	5.75		20	66	28	36	6	○
D106-03-05800A1 AP30P1U	5.8		20	66	28	36	6	●
D106-03-05900A1 AP30P1U	5.9		20	66	28	36	6	●
D106-03-05953A1 AP30P1U	5.953	15/64"	20	66	28	36	6	○
D106-03-06000A1 AP30P1U	6		20	66	28	36	6	●
D106-03-06100A1 AP30P1U	6.1		24	79	41	36	8	○
D106-03-06200A1 AP30P1U	6.2		24	79	41	36	8	○
D106-03-06300A1 AP30P1U	6.3		24	79	41	36	8	○
D106-03-06350A1 AP30P1U	6.35	1/4"	24	79	41	36	8	○
D106-03-06400A1 AP30P1U	6.4		24	79	41	36	8	○
D106-03-06500A1 AP30P1U	6.5		24	79	41	36	8	●
D106-03-06600A1 AP30P1U	6.6		24	79	41	36	8	○
D106-03-06700A1 AP30P1U	6.7		24	79	41	36	8	○
D106-03-06747A1 AP30P1U	6.747	17/64"	24	79	41	36	8	○
D106-03-06800A1 AP30P1U	6.8		24	79	41	36	8	●
D106-03-06900A1 AP30P1U	6.9		24	79	41	36	8	●
D106-03-07000A1 AP30P1U	7		24	79	41	36	8	●
D106-03-07100A1 AP30P1U	7.1		29	79	41	36	8	○
D106-03-07144A1 AP30P1U	7.144	9/32"	29	79	41	36	8	○
D106-03-07200A1 AP30P1U	7.2		29	79	41	36	8	○
D106-03-07250A1 AP30P1U	7.25		29	79	41	36	8	○
D106-03-07300A1 AP30P1U	7.3		29	79	41	36	8	○
D106-03-07400A1 AP30P1U	7.4		29	79	41	36	8	●
D106-03-07450A1 AP30P1U	7.45		29	79	41	36	8	○
D106-03-07500A1 AP30P1U	7.5		29	79	41	36	8	●
D106-03-07541A1 AP30P1U	7.541	19/64"	29	79	41	36	8	○
D106-03-07550A1 AP30P1U	7.55		29	79	41	36	8	○
D106-03-07600A1 AP30P1U	7.6		29	79	41	36	8	○
D106-03-07700A1 AP30P1U	7.7		29	79	41	36	8	○
D106-03-07800A1 AP30P1U	7.8		29	79	41	36	8	●
D106-03-07900A1 AP30P1U	7.9		29	79	41	36	8	●
D106-03-07938A1 AP30P1U	7.938	5/16"	29	79	41	36	8	○
D106-03-08000A1 AP30P1U	8		29	79	41	36	8	●
D106-03-08100A1 AP30P1U	8.1		35	89	47	40	10	○
D106-03-08200A1 AP30P1U	8.2		35	89	47	40	10	○
D106-03-08300A1 AP30P1U	8.3		35	89	47	40	10	○
D106-03-08334A1 AP30P1U	8.334	21/64"	35	89	47	40	10	○
D106-03-08400A1 AP30P1U	8.4		35	89	47	40	10	○
D106-03-08500A1 AP30P1U	8.5		35	89	47	40	10	●
D106-03-08600A1 AP30P1U	8.6		35	89	47	40	10	●
D106-03-08700A1 AP30P1U	8.7		35	89	47	40	10	○
D106-03-08731A1 AP30P1U	8.731	11/32"	35	89	47	40	10	○
D106-03-08750A1 AP30P1U	8.75		35	89	47	40	10	○
D106-03-08800A1 AP30P1U	8.8		35	89	47	40	10	●
D106-03-08900A1 AP30P1U	8.9		35	89	47	40	10	●

Special product can be ordered

Marked: ● Stocked ○ Limited-stock

Solid Carbide Drill D106 with Internal Coolant 3xDc

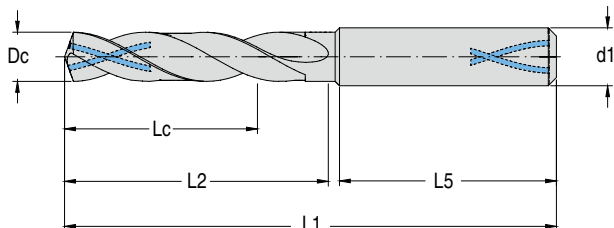

P	M	K	N	S	H
••	•	••	••	•	•

•• 1st choice • 2nd choice

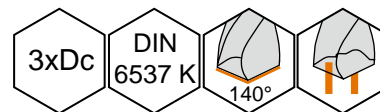

Product code	Dc(m7) mm	Dc inch/No.	Lc mm	L1 mm	L2 mm	L5 mm	d1(h6) mm	stock
D106-03-09000A1 AP30P1U	9		35	89	47	40	10	●
D106-03-09100A1 AP30P1U	9.1		35	89	47	40	10	○
D106-03-09128A1 AP30P1U	9.128	23/64"	35	89	47	40	10	○
D106-03-09200A1 AP30P1U	9.2		35	89	47	40	10	○
D106-03-09300A1 AP30P1U	9.3		35	89	47	40	10	●
D106-03-09400A1 AP30P1U	9.4		35	89	47	40	10	○
D106-03-09500A1 AP30P1U	9.5		35	89	47	40	10	○
D106-03-09525A1 AP30P1U	9.525	3/8"	35	89	47	40	10	○
D106-03-09550A1 AP30P1U	9.55		35	89	47	40	10	○
D106-03-09600A1 AP30P1U	9.6		35	89	47	40	10	○
D106-03-09700A1 AP30P1U	9.7		35	89	47	40	10	○
D106-03-09800A1 AP30P1U	9.8		35	89	47	40	10	●
D106-03-09900A1 AP30P1U	9.9		35	89	47	40	10	●
D106-03-09922A1 AP30P1U	9.922	25/64"	35	89	47	40	10	○
D106-03-10000A1 AP30P1U	10		35	89	47	40	10	●
D106-03-10100A1 AP30P1U	10.1		40	102	55	45	12	●
D106-03-10200A1 AP30P1U	10.2		40	102	55	45	12	●
D106-03-10300A1 AP30P1U	10.3		40	102	55	45	12	●
D106-03-10319A1 AP30P1U	10.319	13/32"	40	102	55	45	12	○
D106-03-10400A1 AP30P1U	10.4		40	102	55	45	12	○
D106-03-10500A1 AP30P1U	10.5		40	102	55	45	12	●
D106-03-10600A1 AP30P1U	10.6		40	102	55	45	12	●
D106-03-10700A1 AP30P1U	10.7		40	102	55	45	12	○
D106-03-10716A1 AP30P1U	10.716	27/64"	40	102	55	45	12	○
D106-03-10800A1 AP30P1U	10.8		40	102	55	45	12	●
D106-03-10900A1 AP30P1U	10.9		40	102	55	45	12	○
D106-03-11000A1 AP30P1U	11		40	102	55	45	12	●
D106-03-11100A1 AP30P1U	11.1		40	102	55	45	12	○
D106-03-11113A1 AP30P1U	11.113	7/16"	40	102	55	45	12	○
D106-03-11200A1 AP30P1U	11.2		40	102	55	45	12	○
D106-03-11300A1 AP30P1U	11.3		40	102	55	45	12	○
D106-03-11400A1 AP30P1U	11.4		40	102	55	45	12	○
D106-03-11500A1 AP30P1U	11.5		40	102	55	45	12	○
D106-03-11509A1 AP30P1U	11.509	29/64"	40	102	55	45	12	○
D106-03-11550A1 AP30P1U	11.55		40	102	55	45	12	○
D106-03-11600A1 AP30P1U	11.6		40	102	55	45	12	○
D106-03-11700A1 AP30P1U	11.7		40	102	55	45	12	○
D106-03-11800A1 AP30P1U	11.8		40	102	55	45	12	●
D106-03-11900A1 AP30P1U	11.9		40	102	55	45	12	○
D106-03-11906A1 AP30P1U	11.906	15/32"	40	102	55	45	12	○
D106-03-12000A1 AP30P1U	12		40	102	55	45	12	●
D106-03-12100A1 AP30P1U	12.1		43	107	60	45	14	○
D106-03-12200A1 AP30P1U	12.2		43	107	60	45	14	○
D106-03-12250A1 AP30P1U	12.25		43	107	60	45	14	○

Special product can be ordered

Marked: ● Stocked ○ Limited-stock

Solid Carbide Drill

Solid Carbide Drill D106 with Internal Coolant 3xDc

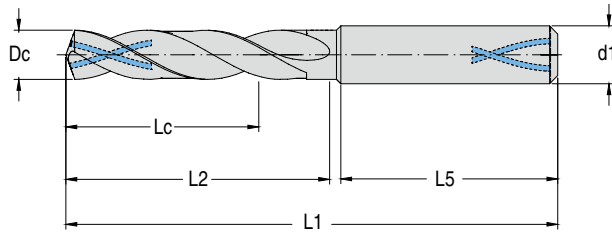

P	M	K	N	S	H
••	•	••	••	•	•

● 1st choice ● 2nd choice

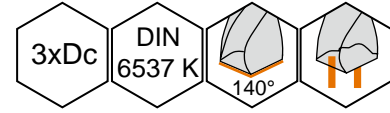

Product code	Dc(m7) mm	Dc inch/No.	Lc mm	L1 mm	L2 mm	L5 mm	d1(h6) mm	stock
D106-03-12300A1 AP30P1U	12.3		43	107	60	45	14	○
D106-03-12303A1 AP30P1U	12.303	31/64"	43	107	60	45	14	○
D106-03-12400A1 AP30P1U	12.4		43	107	60	45	14	○
D106-03-12500A1 AP30P1U	12.5		43	107	60	45	14	●
D106-03-12600A1 AP30P1U	12.6		43	107	60	45	14	○
D106-03-12700A1 AP30P1U	12.7	1/2"	43	107	60	45	14	○
D106-03-12750A1 AP30P1U	12.75		43	107	60	45	14	○
D106-03-12800A1 AP30P1U	12.8		43	107	60	45	14	○
D106-03-12900A1 AP30P1U	12.9		43	107	60	45	14	○
D106-03-13000A1 AP30P1U	13		43	107	60	45	14	●
D106-03-13100A1 AP30P1U	13.1		43	107	60	45	14	○
D106-03-13200A1 AP30P1U	13.2		43	107	60	45	14	●
D106-03-13300A1 AP30P1U	13.3		43	107	60	45	14	○
D106-03-13400A1 AP30P1U	13.4		43	107	60	45	14	○
D106-03-13494A1 AP30P1U	13.494	17/32"	43	107	60	45	14	○
D106-03-13500A1 AP30P1U	13.5		43	107	60	45	14	○
D106-03-13600A1 AP30P1U	13.6		43	107	60	45	14	○
D106-03-13700A1 AP30P1U	13.7		43	107	60	45	14	○
D106-03-13800A1 AP30P1U	13.8		43	107	60	45	14	○
D106-03-13900A1 AP30P1U	13.9		43	107	60	45	14	○
D106-03-14000A1 AP30P1U	14		43	107	60	45	14	●
D106-03-14100A1 AP30P1U	14.1		45	115	65	48	16	●
D106-03-14200A1 AP30P1U	14.2		45	115	65	48	16	●
D106-03-14288A1 AP30P1U	14.288	9/16"	45	115	65	48	16	○
D106-03-14300A1 AP30P1U	14.3		45	115	65	48	16	○
D106-03-14400A1 AP30P1U	14.4		45	115	65	48	16	○
D106-03-14500A1 AP30P1U	14.5		45	115	65	48	16	●
D106-03-14600A1 AP30P1U	14.6		45	115	65	48	16	●
D106-03-14700A1 AP30P1U	14.7		45	115	65	48	16	●
D106-03-14750A1 AP30P1U	14.75		45	115	65	48	16	○
D106-03-14800A1 AP30P1U	14.8		45	115	65	48	16	○
D106-03-15000A1 AP30P1U	15		45	115	65	48	16	●
D106-03-15100A1 AP30P1U	15.1		45	115	65	48	16	○
D106-03-15200A1 AP30P1U	15.2		45	115	65	48	16	○
D106-03-15300A1 AP30P1U	15.3		45	115	65	48	16	○
D106-03-15500A1 AP30P1U	15.5		45	115	65	48	16	●
D106-03-15600A1 AP30P1U	15.6		45	115	65	48	16	○
D106-03-15700A1 AP30P1U	15.7		45	115	65	48	16	●
D106-03-15800A1 AP30P1U	15.8		45	115	65	48	16	●
D106-03-15875A1 AP30P1U	15.875	5/8"	45	115	65	48	16	○
D106-03-15900A1 AP30P1U	15.9		45	115	65	48	16	○
D106-03-16000A1 AP30P1U	16		45	115	65	48	16	●

Special product can be ordered

Marked: ● Stocked ○ Limited-stock

Solid Carbide Drill D106 with Internal Coolant 5xDc

P	M	K	N	S	H
••	•	••	••	•	•
●● 1st choice ● 2nd choice					

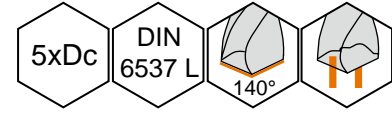
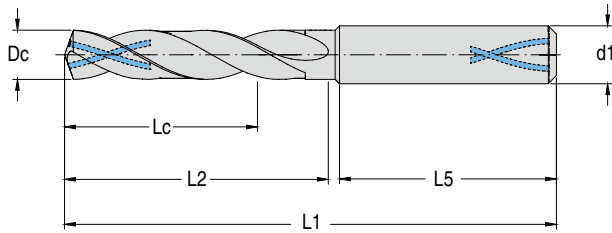

Product code	Dc(m7) mm	Dc inch/No.	Lc mm	L1 mm	L2 mm	L5 mm	d1(h6) mm	stock
D106-05-03000A1 AP30P1U	3		23	66	28	36	4	●
D106-05-03100A1 AP30P1U	3.1		23	66	28	36	4	●
D106-05-03175A1 AP30P1U	3.175	1/8"	23	66	28	36	4	○
D106-05-03200A1 AP30P1U	3.2		23	66	28	36	4	●
D106-05-03250A1 AP30P1U	3.25		23	66	28	36	4	○
D106-05-03300A1 AP30P1U	3.3		23	66	28	36	4	●
D106-05-03400A1 AP30P1U	3.4		23	66	28	36	4	○
D106-05-03500A1 AP30P1U	3.5		23	66	28	36	4	●
D106-05-03572A1 AP30P1U	3.572	9/64"	23	66	28	36	4	○
D106-05-03600A1 AP30P1U	3.6		23	66	28	36	4	●
D106-05-03650A1 AP30P1U	3.65		23	66	28	36	4	○
D106-05-03700A1 AP30P1U	3.7		23	66	28	36	4	●
D106-05-03800A1 AP30P1U	3.8		29	74	36	36	4	○
D106-05-03900A1 AP30P1U	3.9		29	74	36	36	4	●
D106-05-03969A1 AP30P1U	3.969	5/32"	29	74	36	36	4	○
D106-05-04000A1 AP30P1U	4		29	74	36	36	4	●
D106-05-04100A1 AP30P1U	4.1		29	74	36	36	6	○
D106-05-04200A1 AP30P1U	4.2		29	74	36	36	6	●
D106-05-04300A1 AP30P1U	4.3		29	74	36	36	6	○
D106-05-04366A1 AP30P1U	4.366	11/64"	29	74	36	36	6	○
D106-05-04400A1 AP30P1U	4.4		29	74	36	36	6	○
D106-05-04500A1 AP30P1U	4.5		29	74	36	36	6	●
D106-05-04600A1 AP30P1U	4.6		29	74	36	36	6	○
D106-05-04650A1 AP30P1U	4.65		29	74	36	36	6	○
D106-05-04700A1 AP30P1U	4.7		29	74	36	36	6	○
D106-05-04763A1 AP30P1U	4.763	3/16"	35	82	44	36	6	○
D106-05-04800A1 AP30P1U	4.8		35	82	44	36	6	●
D106-05-04900A1 AP30P1U	4.9		35	82	44	36	6	●
D106-05-05000A1 AP30P1U	5		35	82	44	36	6	●
D106-05-05100A1 AP30P1U	5.1		35	82	44	36	6	●
D106-05-05159A1 AP30P1U	5.159	13/64"	35	82	44	36	6	○
D106-05-05200A1 AP30P1U	5.2		35	82	44	36	6	●
D106-05-05300A1 AP30P1U	5.3		35	82	44	36	6	○
D106-05-05400A1 AP30P1U	5.4		35	82	44	36	6	○
D106-05-05500A1 AP30P1U	5.5		35	82	44	36	6	●
D106-05-05550A1 AP30P1U	5.55		35	82	44	36	6	○

Special product can be ordered

Marked: ● Stocked ○ Limited-stock

Solid Carbide Drill

Solid Carbide Drill D106 with Internal Coolant 5xDc

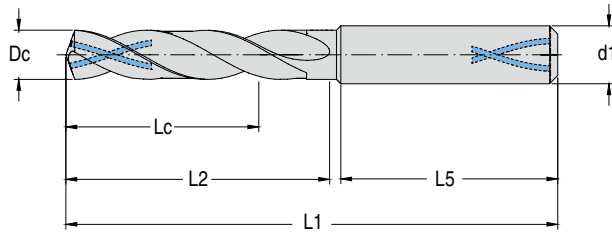

P	M	K	N	S	H
••	•	••	••	•	•

● 1st choice ● 2nd choice

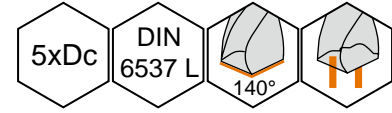

Product code	Dc(m7) mm	Dc inch/No.	Lc mm	L1 mm	L2 mm	L5 mm	d1(h6) mm	stock
D106-05-05556A1 AP30P1U	5.556	7/32"	35	82	44	36	6	○
D106-05-05600A1 AP30P1U	5.6		35	82	44	36	6	○
D106-05-05700A1 AP30P1U	5.7		35	82	44	36	6	○
D106-05-05750A1 AP30P1U	5.75		35	82	44	36	6	○
D106-05-05800A1 AP30P1U	5.8		35	82	44	36	6	●
D106-05-05900A1 AP30P1U	5.9		35	82	44	36	6	●
D106-05-05953A1 AP30P1U	5.953	15/64"	35	82	44	36	6	○
D106-05-06000A1 AP30P1U	6		35	82	44	36	6	●
D106-05-06100A1 AP30P1U	6.1		43	91	53	36	8	○
D106-05-06200A1 AP30P1U	6.2		43	91	53	36	8	○
D106-05-06300A1 AP30P1U	6.3		43	91	53	36	8	○
D106-05-06350A1 AP30P1U	6.35	1/4"	43	91	53	36	8	○
D106-05-06400A1 AP30P1U	6.4		43	91	53	36	8	○
D106-05-06500A1 AP30P1U	6.5		43	91	53	36	8	●
D106-05-06600A1 AP30P1U	6.6		43	91	53	36	8	○
D106-05-06700A1 AP30P1U	6.7		43	91	53	36	8	○
D106-05-06747A1 AP30P1U	6.747	17/64"	43	91	53	36	8	○
D106-05-06800A1 AP30P1U	6.8		43	91	53	36	8	●
D106-05-06900A1 AP30P1U	6.9		43	91	53	36	8	●
D106-05-07000A1 AP30P1U	7		43	91	53	36	8	●
D106-05-07100A1 AP30P1U	7.1		43	91	53	36	8	○
D106-05-07144A1 AP30P1U	7.144	9/32"	43	91	53	36	8	○
D106-05-07200A1 AP30P1U	7.2		43	91	53	36	8	○
D106-05-07250A1 AP30P1U	7.25		43	91	53	36	8	○
D106-05-07300A1 AP30P1U	7.3		43	91	53	36	8	○
D106-05-07400A1 AP30P1U	7.4		43	91	53	36	8	●
D106-05-07450A1 AP30P1U	7.45		43	91	53	36	8	○
D106-05-07500A1 AP30P1U	7.5		43	91	53	36	8	●
D106-05-07541A1 AP30P1U	7.541	19/64"	43	91	53	36	8	○
D106-05-07550A1 AP30P1U	7.55		43	91	53	36	8	○
D106-05-07600A1 AP30P1U	7.6		43	91	53	36	8	○
D106-05-07700A1 AP30P1U	7.7		43	91	53	36	8	○
D106-05-07800A1 AP30P1U	7.8		43	91	53	36	8	●
D106-05-07900A1 AP30P1U	7.9		43	91	53	36	8	●
D106-05-07938A1 AP30P1U	7.938	5/16"	43	91	53	36	8	○
D106-05-08000A1 AP30P1U	8		43	91	53	36	8	●
D106-05-08100A1 AP30P1U	8.1		49	103	61	40	10	○
D106-05-08200A1 AP30P1U	8.2		49	103	61	40	10	○
D106-05-08300A1 AP30P1U	8.3		49	103	61	40	10	○
D106-05-08334A1 AP30P1U	8.334	21/64"	49	103	61	40	10	○
D106-05-08400A1 AP30P1U	8.4		49	103	61	40	10	○
D106-05-08500A1 AP30P1U	8.5		49	103	61	40	10	●
D106-05-08600A1 AP30P1U	8.6		49	103	61	40	10	●
D106-05-08700A1 AP30P1U	8.7		49	103	61	40	10	○
D106-05-08731A1 AP30P1U	8.731	11/32"	49	103	61	40	10	○
D106-05-08750A1 AP30P1U	8.75		49	103	61	40	10	○
D106-05-08800A1 AP30P1U	8.8		49	103	61	40	10	●
D106-05-08900A1 AP30P1U	8.9		49	103	61	40	10	●

Special product can be ordered

Marked: ● Stocked ○ Limited-stock

Solid Carbide Drill D106 with Internal Coolant 5xDc

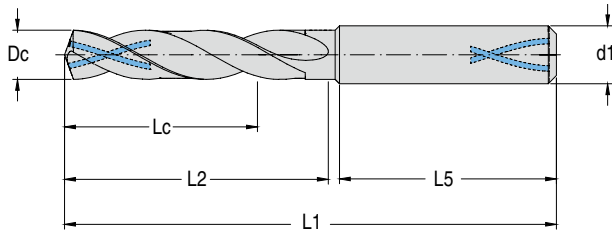

P	M	K	N	S	H
••	•	••	••	•	•

•• 1st choice • 2nd choice

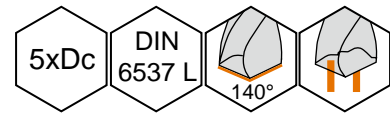

Product code	Dc(m7) mm	Dc inch/No.	Lc mm	L1 mm	L2 mm	L5 mm	d1(h6) mm	stock
D106-05-09000A1 AP30P1U	9		49	103	61	40	10	●
D106-05-09100A1 AP30P1U	9.1		49	103	61	40	10	○
D106-05-09128A1 AP30P1U	9.128	23/64"	49	103	61	40	10	○
D106-05-09200A1 AP30P1U	9.2		49	103	61	40	10	○
D106-05-09300A1 AP30P1U	9.3		49	103	61	40	10	●
D106-05-09400A1 AP30P1U	9.4		49	103	61	40	10	○
D106-05-09500A1 AP30P1U	9.5		49	103	61	40	10	○
D106-05-09525A1 AP30P1U	9.525	3/8"	49	103	61	40	10	○
D106-05-09550A1 AP30P1U	9.55		49	103	61	40	10	○
D106-05-09600A1 AP30P1U	9.6		49	103	61	40	10	○
D106-05-09700A1 AP30P1U	9.7		49	103	61	40	10	○
D106-05-09800A1 AP30P1U	9.8		49	103	61	40	10	●
D106-05-09900A1 AP30P1U	9.9		49	103	61	40	10	●
D106-05-09922A1 AP30P1U	9.922	25/64"	49	103	61	40	10	○
D106-05-10000A1 AP30P1U	10		49	103	61	40	10	●
D106-05-10100A1 AP30P1U	10.1		56	118	71	45	12	●
D106-05-10200A1 AP30P1U	10.2		56	118	71	45	12	●
D106-05-10300A1 AP30P1U	10.3		56	118	71	45	12	●
D106-05-10319A1 AP30P1U	10.319	13/32"	56	118	71	45	12	○
D106-05-10400A1 AP30P1U	10.4		56	118	71	45	12	○
D106-05-10500A1 AP30P1U	10.5		56	118	71	45	12	●
D106-05-10600A1 AP30P1U	10.6		56	118	71	45	12	●
D106-05-10700A1 AP30P1U	10.7		56	118	71	45	12	○
D106-05-10716A1 AP30P1U	10.716	27/64"	56	118	71	45	12	○
D106-05-10800A1 AP30P1U	10.8		56	118	71	45	12	●
D106-05-10900A1 AP30P1U	10.9		56	118	71	45	12	○
D106-05-11000A1 AP30P1U	11		56	118	71	45	12	●
D106-05-11100A1 AP30P1U	11.1		56	118	71	45	12	○
D106-05-11113A1 AP30P1U	11.113	7/16"	56	118	71	45	12	○
D106-05-11200A1 AP30P1U	11.2		56	118	71	45	12	○
D106-05-11300A1 AP30P1U	11.3		56	118	71	45	12	○
D106-05-11400A1 AP30P1U	11.4		56	118	71	45	12	○
D106-05-11500A1 AP30P1U	11.5		56	118	71	45	12	○
D106-05-11509A1 AP30P1U	11.509	29/64"	56	118	71	45	12	○
D106-05-11550A1 AP30P1U	11.55		56	118	71	45	12	○
D106-05-11600A1 AP30P1U	11.6		56	118	71	45	12	○
D106-05-11700A1 AP30P1U	11.7		56	118	71	45	12	○
D106-05-11800A1 AP30P1U	11.8		56	118	71	45	12	●
D106-05-11900A1 AP30P1U	11.9		56	118	71	45	12	○
D106-05-11906A1 AP30P1U	11.906	15/32"	56	118	71	45	12	○
D106-05-12000A1 AP30P1U	12		56	118	71	45	12	●
D106-05-12100A1 AP30P1U	12.1		60	124	77	45	14	○
D106-05-12200A1 AP30P1U	12.2		60	124	77	45	14	○
D106-05-12250A1 AP30P1U	12.25		60	124	77	45	14	○

Special product can be ordered

Marked: ● Stocked ○ Limited-stock

Solid Carbide Drill

Solid Carbide Drill D106 with Internal Coolant 5xDc

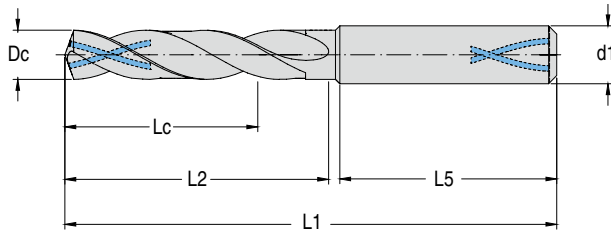

P	M	K	N	S	H
••	•	••	••	•	•
● 1st choice ● 2nd choice					

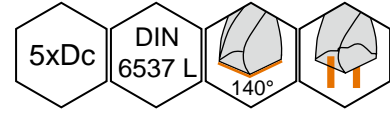

Product code	Dc(m7) mm	Dc inch/No.	Lc mm	L1 mm	L2 mm	L5 mm	d1(h6) mm	stock
D106-05-12300A1 AP30P1U	12.3		60	124	77	45	14	○
D106-05-12303A1 AP30P1U	12.303	31/64"	60	124	77	45	14	○
D106-05-12400A1 AP30P1U	12.4		60	124	77	45	14	○
D106-05-12500A1 AP30P1U	12.5		60	124	77	45	14	●
D106-05-12600A1 AP30P1U	12.6		60	124	77	45	14	○
D106-05-12700A1 AP30P1U	12.7	1/2"	60	124	77	45	14	○
D106-05-12750A1 AP30P1U	12.75		60	124	77	45	14	○
D106-05-12800A1 AP30P1U	12.8		60	124	77	45	14	○
D106-05-12900A1 AP30P1U	12.9		60	124	77	45	14	○
D106-05-13000A1 AP30P1U	13		60	124	77	45	14	●
D106-05-13100A1 AP30P1U	13.1		60	124	77	45	14	○
D106-05-13200A1 AP30P1U	13.2		60	124	77	45	14	●
D106-05-13300A1 AP30P1U	13.3		60	124	77	45	14	○
D106-05-13400A1 AP30P1U	13.4		60	124	77	45	14	○
D106-05-13494A1 AP30P1U	13.494	17/32"	60	124	77	45	14	○
D106-05-13500A1 AP30P1U	13.5		60	124	77	45	14	○
D106-05-13600A1 AP30P1U	13.6		60	124	77	45	14	○
D106-05-13700A1 AP30P1U	13.7		60	124	77	45	14	●
D106-05-13800A1 AP30P1U	13.8		60	124	77	45	14	○
D106-05-13900A1 AP30P1U	13.9		60	124	77	45	14	○
D106-05-14000A1 AP30P1U	14		60	124	77	45	14	●
D106-05-14100A1 AP30P1U	14.1		63	133	83	48	16	●
D106-05-14200A1 AP30P1U	14.2		63	133	83	48	16	●
D106-05-14288A1 AP30P1U	14.288	9/16"	63	133	83	48	16	○
D106-05-14300A1 AP30P1U	14.3		63	133	83	48	16	○
D106-05-14400A1 AP30P1U	14.4		63	133	83	48	16	○
D106-05-14500A1 AP30P1U	14.5		63	133	83	48	16	●
D106-05-14600A1 AP30P1U	14.6		63	133	83	48	16	●
D106-05-14700A1 AP30P1U	14.7		63	133	83	48	16	●
D106-05-14750A1 AP30P1U	14.75		63	133	83	48	16	○
D106-05-14800A1 AP30P1U	14.8		63	133	83	48	16	○
D106-05-15000A1 AP30P1U	15		63	133	83	48	16	●
D106-05-15100A1 AP30P1U	15.1		63	133	83	48	16	○
D106-05-15200A1 AP30P1U	15.2		63	133	83	48	16	○
D106-05-15300A1 AP30P1U	15.3		63	133	83	48	16	○
D106-05-15500A1 AP30P1U	15.5		63	133	83	48	16	●
D106-05-15600A1 AP30P1U	15.6		63	133	83	48	16	○
D106-05-15700A1 AP30P1U	15.7		63	133	83	48	16	●
D106-05-15800A1 AP30P1U	15.8		63	133	83	48	16	●
D106-05-15875A1 AP30P1U	15.875	5/8"	63	133	83	48	16	○
D106-05-15900A1 AP30P1U	15.9		63	133	83	48	16	○
D106-05-16000A1 AP30P1U	16		63	133	83	48	16	●

Special product can be ordered

Marked: ● Stocked ○ Limited-stock

Solid Carbide Drill D108 with Internal Coolant 8xDc

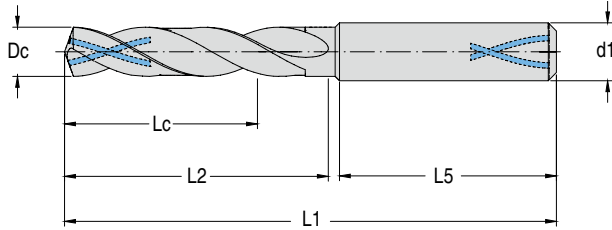

P	M	K	N	S	H
••	•	••	••	•	•

•• 1st choice • 2nd choice

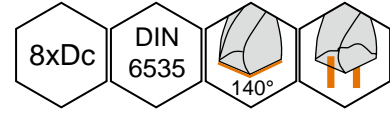

Product code	Dc(m7) mm	Dc inch/No.	Lc mm	L1 mm	L2 mm	L5 mm	d1(h6) mm	stock
D108-08-03000A1	3		28	74	34	36	6	●
D108-08-03100A1	3.1		28	74	34	36	6	●
D108-08-03175A1	3.175	1/8"	28	74	34	36	6	○
D108-08-03200A1	3.2		28	74	34	36	6	●
D108-08-03300A1	3.3		28	74	34	36	6	●
D108-08-03400A1	3.4		28	74	34	36	6	●
D108-08-03500A1	3.5		28	74	34	36	6	●
D108-08-03572A1	3.572	9/64"	28	74	34	36	6	○
D108-08-03600A1	3.6		28	74	34	36	6	●
D108-08-03700A1	3.7		28	74	34	36	6	●
D108-08-03800A1	3.8		35	81	42	36	6	●
D108-08-03900A1	3.9		35	81	42	36	6	●
D108-08-03969A1	3.969	5/32"	35	81	42	36	6	○
D108-08-04000A1	4		35	81	42	36	6	●
D108-08-04100A1	4.1		35	81	42	36	6	●
D108-08-04200A1	4.2		35	81	42	36	6	●
D108-08-04300A1	4.3		37	81	44	36	6	●
D108-08-04366A1	4.366	11/64"	37	81	44	36	6	○
D108-08-04400A1	4.4		37	81	44	36	6	●
D108-08-04500A1	4.5		37	81	44	36	6	●
D108-08-04600A1	4.6		37	81	44	36	6	●
D108-08-04700A1	4.7		37	81	44	36	6	●
D108-08-04763A1	4.763	3/16"	43	97	52	36	6	○
D108-08-04800A1	4.8		43	97	52	36	6	●
D108-08-04900A1	4.9		43	97	52	36	6	●
D108-08-05000A1	5		45	97	55	36	6	●
D108-08-05100A1	5.1		45	97	55	36	6	●
D108-08-05159A1	5.159	13/64"	45	97	55	36	6	○
D108-08-05200A1	5.2		45	97	55	36	6	●
D108-08-05300A1	5.3		45	97	55	36	6	●
D108-08-05400A1	5.4		48	97	57	36	6	●
D108-08-05500A1	5.5		48	97	57	36	6	●
D108-08-05556A1	5.556	7/32"	48	97	57	36	6	●
D108-08-05600A1	5.6		48	97	57	36	6	●
D108-08-05700A1	5.7		48	97	57	36	6	●
D108-08-05800A1	5.8		48	97	57	36	6	●
D108-08-05900A1	5.9		48	97	57	36	6	●
D108-08-05953A1	5.953	15/64"	48	97	57	36	6	○
D108-08-06000A1	6		48	97	57	36	6	●
D108-08-06100A1	6.1		53	106	64	36	8	●
D108-08-06200A1	6.2		53	106	64	36	8	●

Special product can be ordered

Marked: ● Stocked ○ Limited-stock

Solid Carbide Drill

Solid Carbide Drill D108 with Internal Coolant 8xDc

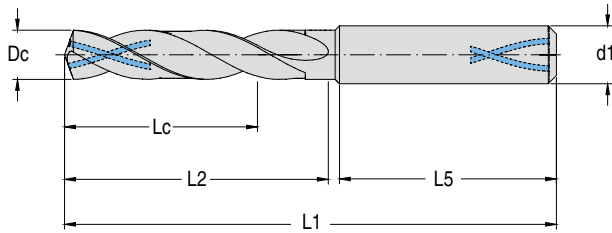

P	M	K	N	S	H
••	•	••	••	•	•

● 1st choice ● 2nd choice

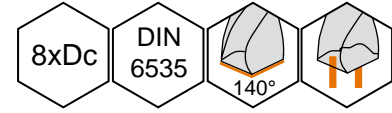

Product code	Dc(m7) mm	Dc inch/No.	Lc mm	L1 mm	L2 mm	L5 mm	d1(h6) mm	stock
D108-08-06300A1	6.3		53	106	64	36	8	●
D108-08-06350A1	6.35	1/4"	54	106	66	36	8	●
D108-08-06400A1	6.4		54	106	66	36	8	●
D108-08-06500A1	6.5		55	106	66	36	8	●
D108-08-06600A1	6.6		55	106	66	36	8	●
D108-08-06700A1	6.7		55	106	66	36	8	●
D108-08-06747A1	6.747	17/64"	55	106	66	36	8	○
D108-08-06800A1	6.8		55	106	66	36	8	●
D108-08-06900A1	6.9		55	106	66	36	8	●
D108-08-07000A1	7		55	106	66	36	8	●
D108-08-07100A1	7.1		60	116	74	36	8	●
D108-08-07144A1	7.144	9/32"	60	116	74	36	8	○
D108-08-07200A1	7.2		62	116	74	36	8	●
D108-08-07300A1	7.3		62	116	74	36	8	●
D108-08-07400A1	7.4		62	116	74	36	8	●
D108-08-07500A1	7.5		64	116	76	36	8	●
D108-08-07541A1	7.541	19/64"	64	116	76	36	8	○
D108-08-07600A1	7.6		64	116	76	36	8	●
D108-08-07700A1	7.7		64	116	76	36	8	●
D108-08-07800A1	7.8		64	116	76	36	8	●
D108-08-07900A1	7.9		64	116	76	36	8	●
D108-08-07938A1	7.938	5/16"	64	116	76	36	8	○
D108-08-08000A1	8		64	116	76	36	8	●
D108-08-08100A1	8.1		70	139	88	40	10	●
D108-08-08200A1	8.2		70	139	88	40	10	●
D108-08-08300A1	8.3		72	139	88	40	10	●
D108-08-08334A1	8.334	21/64"	72	139	88	40	10	○
D108-08-08400A1	8.4		72	139	88	40	10	●
D108-08-08500A1	8.5		72	139	88	40	10	●
D108-08-08600A1	8.6		72	139	88	40	10	●
D108-08-08700A1	8.7		74	139	90	40	10	●
D108-08-08731A1	8.731	11/32"	74	139	90	40	10	○
D108-08-08800A1	8.8		74	139	90	40	10	●
D108-08-08900A1	8.9		76	139	92	40	10	●
D108-08-09000A1	9		76	139	92	40	10	●
D108-08-09100A1	9.1		78	139	95	40	10	●
D108-08-09128A1	9.128	23/64"	78	139	95	40	10	○
D108-08-09200A1	9.2		80	139	95	40	10	●
D108-08-09300A1	9.3		80	139	95	40	10	●

Special product can be ordered

Marked: ● Stocked ○ Limited-stock

Solid Carbide Drill D108 with Internal Coolant 8xDc

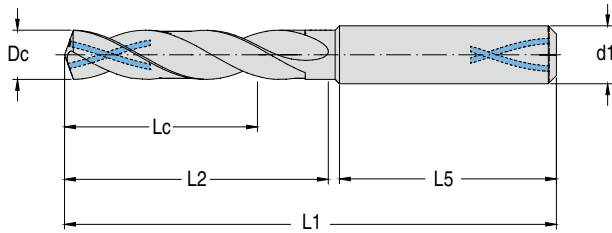

P	M	K	N	S	H
••	•	••	••	•	•

•• 1st choice • 2nd choice

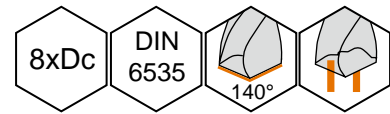





Product code	Dc(m7) mm	Dc inch/No.	Lc mm	L1 mm	L2 mm	L5 mm	d1(h6) mm	stock
D108-08-09400A1	9.4		80	139	95	40	10	●
D108-08-09500A1	9.5		80	139	95	40	10	●
D108-08-09525A1	9.525	3/8"	80	139	95	40	10	●
D108-08-09600A1	9.6		80	139	95	40	10	●
D108-08-09700A1	9.7		80	139	95	40	10	●
D108-08-09800A1	9.8		80	139	95	40	10	●
D108-08-09900A1	9.9		80	139	95	40	10	●
D108-08-09922A1	9.922	25/64"	80	139	95	40	10	○
D108-08-10000A1	10		80	139	95	40	10	●
D108-08-10100A1	10.1		88	163	108	45	12	●
D108-08-10200A1	10.2		88	163	108	45	12	●
D108-08-10300A1	10.3		88	163	108	45	12	●
D108-08-10319A1	10.319	13/32"	88	163	108	45	12	○
D108-08-10400A1	10.4		90	163	110	45	12	●
D108-08-10500A1	10.5		90	163	110	45	12	●
D108-08-10700A1	10.7		90	163	110	45	12	●
D108-08-10716A1	10.716	27/64"	92	163	110	45	12	○
D108-08-10800A1	10.8		92	163	110	45	12	●
D108-08-10900A1	10.9		94	163	112	45	12	●
D108-08-11000A1	11		94	163	112	45	12	●
D108-08-11100A1	11.1		94	163	112	45	12	●
D108-08-11113A1	11.113	7/16"	94	163	112	45	12	○
D108-08-11200A1	11.2		96	163	114	45	12	●
D108-08-11300A1	11.3		96	163	114	45	12	●
D108-08-11500A1	11.5		96	163	114	45	12	●
D108-08-11600A1	11.6		96	163	114	45	12	●
D108-08-11700A1	11.7		96	163	114	45	12	●
D108-08-11800A1	11.8		96	163	114	45	12	●
D108-08-11900A1	11.9		96	163	114	45	12	●
D108-08-11906A1	11.906	15/32"	96	163	114	45	12	○
D108-08-12000A1	12		96	163	114	45	12	●
D108-08-12303A1	12.303	31/64"	106	182	125	45	14	○
D108-08-12500A1	12.5		106	182	125	45	14	●
D108-08-12700A1	12.7	1/2"	106	182	125	45	14	○
D108-08-13000A1	13		110	182	130	45	14	●
D108-08-13494A1	13.494	17/32"	115	182	133	45	14	○
D108-08-13500A1	13.5		115	182	133	45	14	●
D108-08-14000A1	14		119	182	133	45	14	●
D108-08-14288A1	14.288	9/16"	122	204	140	48	16	○
D108-08-14500A1	14.5		124	204	140	48	16	●
D108-08-15000A1	15		128	204	143	48	16	●
D108-08-15500A1	15.5		132	204	150	48	16	●
D108-08-15875A1	15.875	5/8"	134	204	150	48	16	○
D108-08-16000A1	16		136	204	152	48	16	●

Special product can be ordered

Marked: ● Stocked ○ Limited-stock

Solid Carbide Drill

Cutting Data for D106 Solid Carbide Drill Family

Vc=Cutting speed (m/min) Feed code = feed reference table see page 419				Drilling depth		3xDc				5xDc				8xDc			
																	
				Product family		D106		D106		D106		D106		D106		D108	
				Dia. Range(mm)		3.00-20.00		3.00-16.00		3.00-20.00		3.00-16.00		3.00-16.00		3.00-16.00	
				Coolant		External coolant		Internal coolant		External coolant		Internal coolant		Internal coolant		Internal coolant	
Workpiece material				Brinell hardness (HB)	Tensile strength (N/mm ²)	Vc	Feed code	Vc	Feed code	Vc	Feed code	Vc	Feed code	Vc	Feed code		
P	Unalloyed steel	C≤0.25%	Annealed	125	428	80-100	F	90-115	F	80-100	F	90-115	F	90-115	F		
		0.25 < C ≤ 0.55%	Annealed	190	639	70-90	E	80-100	E	70-90	E	80-100	E	80-100	E		
		0.25 < C ≤ 0.55%	Heat-treated	210	708	70-90	E	80-100	E	70-90	E	80-100	E	80-100	E		
		C > 0.55%	Annealed	190	639	70-90	E	80-100	E	70-90	E	80-100	E	80-100	E		
		C > 0.55%	Heat-treated	300	1013	50-70	D	50-70	D	50-70	D	50-70	D	50-70	D		
	Low-alloyed steel	Free cutting steel (short-chipping)	Annealed	Annealed	175	591	70-100	E	80-110	E	70-100	E	80-110	E	80-110	E	
			Heat-treated	Heat-treated	300	1013	50-70	D	60-70	D	50-70	D	60-70	D	60-70	D	
			Heat-treated	Heat-treated	380	1282	35-45	C	40-50	C	35-45	C	40-50	C	40-50	C	
			Heat-treated	Heat-treated	430	1477	30-40	B	30-40	B	30-40	B	30-40	B	30-40	B	
	High-alloyed steel and high-alloyed tool steel		Annealed	Annealed	200	675	55-65	D	60-80	D	55-65	D	60-80	D	60-80	D	
			Hardened and tempered	Hardened and tempered	300	1013	40-50	C	40-60	C	40-50	C	40-60	C	40-60	C	
			Hardened and tempered	Hardened and tempered	400	1361	30-40	C	45-50	C	30-40	C	45-50	C	45-50	C	
	Stainless steel		Ferritic/martensitic, annealed	Ferritic/martensitic, annealed	200	675	50-70	D	60-80	D	50-70	D	60-80	D	60-80	D	
			Martensitic, heat-treated	Martensitic, heat-treated	330	1114	40-50	C	40-50	C	40-50	C	40-50	C	40-50	C	
M	Stainless steel	Austenitic, quench hardened	Austenitic, quench hardened	200	675			40-50	C			40-50	C	40-50	C		
		Austenitic, precipitation hardened (PH)	Austenitic, precipitation hardened (PH)	300	1013	35-45	C	40-50	C	35-45	C	40-50	C	40-50	C		
		Austenitic/ferritic, duplex	Austenitic/ferritic, duplex	230	778			25-35	B			25-35	B	25-35	B		
K	Malleable cast iron	Ferritic	Ferritic	200	400	70-90	G	70-90	G	70-90	G	70-90	G	70-90	G		
		Pearlitic	Pearlitic	260	700	60-80	G	60-80	G	60-80	G	60-80	G	60-80	G		
	Grey cast iron	Low tensile strength	Low tensile strength	180	200	80-100	H	80-110	H	80-100	H	80-110	H	80-110	H		
		High tensile strength/austenitic	High tensile strength/austenitic	245	350	70-90	G	70-90	G	70-90	G	70-90	G	70-90	G		
	Cast iron with spheroidal graphite	Ferritic	Ferritic	155	400	80-100	G	80-110	H	80-100	G	80-110	H	80-110	H		
		Pearlitic	Pearlitic	265	700	60-80	F	60-80	F	60-80	F	60-80	F	60-80	F		
	GGV(CGI)	GGV(CGI)	230	400	60-80	F	60-80	F	60-80	F	60-80	F	60-80	F			
N	Wrought aluminium alloys	non-aging	non-aging	30	-	200-300	G	300-400	G	200-300	G	300-400	G	300-400	G		
		aged	aged	100	340	200-300	G	300-400	G	200-300	G	300-400	G	300-400	G		
	Cast aluminium alloys	≤ 12% Si, non-aging	≤ 12% Si, non-aging	75	260	160-220	H	180-240	H	160-220	H	180-240	H	180-240	H		
		≤ 12% Si, aged	≤ 12% Si, aged	90	310	160-200	H	180-200	H	160-200	H	180-200	H	180-200	H		
		> 12% Si, non-aging	> 12% Si, non-aging	130	450	130-160	G	140-180	G	130-160	G	140-180	G	140-180	G		
	Magnesium alloys			70	250												
		Copper and copper alloys (bronze/brass)	Unalloyed, electrolytic copper	Unalloyed, electrolytic copper	100	340	120-160	C	140-170	D	120-160	C	140-170	D	140-170	D	
Brass, bronze, red brass			Brass, bronze, red brass	90	310	110-140	E	120-140	E	110-140	E	120-140	E	120-140	E		
Cu alloys, short-chip			Cu alloys, short-chip	110	380	120-150	F	140-180	F	120-150	F	140-180	F	140-180	F		
High tensile, Ampco alloy	High tensile, Ampco alloy		300	1010	45-60	B	45-60	B	45-60	B	45-60	B	45-60	B			
S	Heat-resistant alloys	Fe-based	Annealed	Annealed	200	680			30-40	B			30-40	B	30-40	B	
			Hardened	Hardened	280	940			20-25	A			20-25	A	20-25	A	
		Ni or Co based	Annealed	Annealed	250	840			20-30	B			20-30	B	20-30	B	
			Hardened	Hardened	350	1180			10-15	A			10-15	A	10-15	A	
			Cast	Cast	320	1080			15-25	A			15-25	A	15-25	A	
	Titanium alloys	Pure titanium	Pure titanium	200	680	30-40	B	40-50	C	30-40	B	40-50	C	40-50	C		
		α and β alloys, hardened	α and β alloys, hardened	375	1260	20-30	A	25-35	B	20-30	A	25-35	B	25-35	B		
		β alloys	β alloys	410	1400			10-15	A			10-15	A	10-15	A		
	Tungsten alloys			300	1010			10-15	A			10-15	A	10-15	A		
	Molybdenum alloys			300	1010			10-15	A			10-15	A	10-15	A		
H	Hardened steel	Hardened and tempered	Hardened and tempered	50HRC	-	20-35	A	20-35	A	20-35	A	20-35	A	20-35	A		
		Hardened and tempered	Hardened and tempered	55HRC	-												
		Hardened and tempered	Hardened and tempered	60HRC	-												
	Chilled cast iron	Hardened and tempered	50HRC	-													

The specified cutting data are average recommended values. For special applications, adjustment is needed.

Feed Reference Table

		Feed rate f (mm/rev)							
Dia. mm		A	B	C	D	E	F	G	H
	3.0	0.03	0.04	0.05	0.06	0.08	0.10	0.12	0.14
	4.0	0.04	0.05	0.06	0.08	0.10	0.12	0.14	0.16
	5.0	0.05	0.06	0.07	0.09	0.10	0.12	0.16	0.18
	6.0	0.05	0.07	0.08	0.10	0.12	0.15	0.18	0.20
	8.0	0.06	0.08	0.10	0.12	0.15	0.18	0.20	0.23
	10.0	0.08	0.10	0.12	0.14	0.18	0.20	0.24	0.28
	12.0	0.10	0.12	0.14	0.18	0.20	0.24	0.28	0.32
	14.0	0.10	0.14	0.18	0.20	0.24	0.28	0.32	0.34
	16.0	0.12	0.15	0.18	0.20	0.25	0.30	0.34	0.36
20.0	0.15	0.16	0.20	0.25	0.30	0.34	0.37	0.40	

Thread Pilot Hole Diameters Before Tapping

M			
Metric ISO coarse pitch thread DIN 13 and DIN ISO 965-1			
D	D1		
Diameter	Min (mm)	Max (mm) 5H/6H	Diameter
M4	3.242	3.422	3.30
M4.5	3.688	3.878	3.70
M5	4.134	4.334	4.20
M6	4.917	5.153	5.00
M7	5.917	6.153	6.00
M8	6.647	6.912	6.80
M9	7.647	7.912	7.80
M10	8.376	8.676	8.50
M11	9.376	9.676	9.50
M12	10.106	10.441	10.20
M14	11.835	12.210	12.00
M16	13.835	14.210	14.00
M18	15.294	15.744	15.50
M20	17.294	17.744	17.50
M22	19.294	19.744	19.50

UNC			
Coarse thread ASME B1.1 standard			
D	D1		
Diameter P Gg/1"	Min (mm) 2B/3B	Max (mm) 2B	Diameter
8-32 UNC	3.302	3.531	3.50
10-24 UNC	3.683	3.962	3.90
12-24 UNC	4.343	4.597	4.50
1/4-20 UNC	4.976	5.268	5.10
5/16-18 UNC	6.411	6.734	6.60
3/8-16 UNC	7.805	8.164	8.00
7/16-14 UNC	9.149	9.550	9.40
1/2-13 UNC	10.584	11.013	10.28
9/16-12 UNC	11.996	12.456	12.20
5/8-11 UNC	13.376	13.868	13.50
3/4-10 UNC	16.299	16.833	16.50
7/8-9 UNC	19.169	19.748	19.50

UNF			
Fine thread ASME B1.1 standard			
D	D1		
Diameter P Gg/1"	Min (mm) 2B/3B	Max (mm) 2B	Diameter
8-36 UNF	3.404	3.607	3.50
10-32 UNF	3.962	4.166	4.10
12-28 UNF	4.496	4.724	4.60
1/4-28 UNF	5.367	5.580	5.50
5/16-24 UNF	6.792	7.038	6.90
3/8-24 UNF	8.379	8.626	8.50
7/16-20 UNF	9.738	10.030	9.90
1/2-20 UNF	11.326	11.618	11.50
9/16-18 UNF	12.761	13.084	12.90
5/8-18 UNF	14.348	14.671	14.50
3/4-16 UNF	17.330	17.689	17.50

MF			
Metric ISO fine pitch thread DIN 13 and DIN ISO 965-1			
D	D1		
Diameter x P	Max (mm) 5H/6H	Diameter	
M3.5x0.35	3.221	3.15	
M4x0.35	3.721	3.65	
M4x0.5	3.599	3.50	
M4.5x0.5	4.099	4.00	
M5x0.35	4.721	4.65	
M5x0.5	4.599	4.50	
M5x0.75	4.378	4.20	
M5x0.5	5.599	5.50	
M6x0.75	5.378	5.25	
M7x0.5	6.599	6.50	
M7x0.75	6.378	6.25	
M8x0.5	7.599	7.50	
M8x0.75	7.378	7.25	
M8x1	7.153	7.00	
M9x0.75	8.378	8.25	
M9x1	8.153	8.00	
M10x0.5	9.599	9.50	
M10x0.75	9.378	9.25	
M10x1	9.153	9.00	
M10x1.25	8.912	8.75	
M11x1	10.153	10.00	
M12x0.5	11.599	11.50	
M12x1	11.153	11.00	
M12x1.25	10.912	10.75	
M12x1.5	10.676	10.50	
M13x1	12.153	12.00	
M14x0.75	13.378	13.20	
M14x1	13.153	13.00	
M14x1.25	12.912	12.75	
M14x1.5	12.676	12.50	
M15x1	14.153	14.00	
M15x1.5	13.676	13.50	
M16x0.75	15.378	15.20	
M16x1	15.153	15.00	
M16x1.25	14.912	14.80	
M16x1.5	14.676	14.50	
M17x1	16.153	16.00	
M18x1	17.153	17.00	
M18x1.5	16.676	16.50	
M18x2	16.21	16.00	
M20x1	19.153	19.00	
M20x1.5	18.676	18.50	
M20x2	18.21	18.00	

Thread Pilot Hole Diameters Before Forming

M	Metric ISO coarse pitch thread DIN 13 and DIN ISO 965-1
D	
Diameter	Diameter
M3.5	3.25
M4	3.70
M5	4.65
M6	5.55
M8	7.40
M10	9.30
M12	11.20
M14	13.10
M16	15.10
M18	16.90
M20	18.90

MF	Metric ISO fine pitch thread DIN 13 and DIN ISO 965-1
D	
Diameter x P	Diameter
M4x0.5	3.80
M5x0.5	4.80
M6x0.5	5.80
M6x0.75	5.65
M7x0.75	6.65
M8x0.75	7.65
M8x1	7.55
M10x0.75	9.65
M10x1	9.55
M10x1.25	9.40
M12x1	11.55
M12x1.25	11.40
M12x1.5	11.30
M14x1	13.55
M14x1.5	13.30
M16x1	15.55
M16x1.5	15.30
M18x1	17.55
M18x1.5	17.30
M20x1.5	19.30
M20x2	19.10
M22x1.5	21.30

UNC	Coarse thread ASME B1.1 standard
D	
Diameter	Diameter
6-32 UNC	3.15
8-32 UNC	3.80
10-24 UNC	4.30
12-24 UNC	5.00
1/4-20 UNC	5.75
5/16-18 UNC	7.25
3/8-16 UNC	8.75
7/16-14 UNC	10.30
1/2-13 UNC	11.80
9/16-12 UNC	13.30
5/8-11 UNC	14.80
3/4-10 UNC	17.90

UNF	Fine thread ASME B1.1 standard
D	
Diameter	Diameter
6-40 UNF	3.20
8-36 UNF	3.85
10-32 UNF	4.45
12-28 UNF	5.05
1/4-28 UNF	5.90
5/16-24 UNF	7.45
3/8-24 UNF	9.00
7/16-20 UNF	10.50
1/2-20 UNF	12.10
9/16-18 UNF	13.70
5/8-18 UNF	15.25
3/4-16 UNF	18.40

Solid Carbide Drill

ACHTECK

www.achtecktool.com/en



THE EXPERT OF DIFFICULT MACHINING



CUTTING TOOL CATALOGUE

Thread Milling	422
Over View of Thread Milling Products	424
Thread Milling Denomination System	425
Toolholder List	426
Insert List	427
Metric Thread Tool Recommendation	428
US thread Tool Recommendation	429
G-Thread(BSP) Tool Selection	430
Cutting Parameters	431

Thread Milling Product Range Overview

Tools	Series	ATM60	
	Thread depth	2.5XDN	
	Designation	Single-row thread milling cutter with indexable inserts	
	Insert grade	AP320U	
	Insert code	TM60, TM55	
	Coolant supply	Internal coolant	
	Milling thread type	M ; MF ; MJ ; UNC ; UNF ; UNEF ; UN ; UNJ ; G ;	
	Hole with thread		

Indexable Thread Milling Cutter Denomination - Tool Holder

A	TM	60	-	024	-	Z01	-	068	-	W	25	R	-	09	-	007
1	2	3	-	4	-	5	-	6	-	7	8	9	-	10	-	11

1- Company Name ACHTECK	2-Product Group Thread milling	3- Insert Shape T-Type	4- Cutter Diameter 16 19 24 30 35	5- Number of Teeth 01 03
6- Effective Length of Holder 52 55 80 90	7:8-Shank Type and Size W16 Weldon 16 W20 Weldon 20 W25 Weldon 25 W32 Weldon 32 W40 Weldon 40	9- Tool Rotation Direction R: Right	10- Insert Size 06 09 11 14	11-Axial Distance Between Rows 006 007 012 Without mark means single row

Indexable Thread Milling Cutter Denomination - Inserts

TM	60	G	-	09	02	02	E	-	MU1	AP320U
1	2	3	-	4	5	3	7	-	8	9

1- Category Thread milling inserts	2- Insert Code 60 Positive triangle insert 60° thread angle 55 Positive triangle insert 55° thread angle	3- Process G-Ground insert M-Pressed insert	4- Dimensions 06 09 11 14	5- Thickness T1=1.98 02=2.38 03=3.18
6- Corner Radius 01 02 04	7- Edge Type E-type	8-Chip Breaker MU1 Universal	9- Grade AP320U	

Thread milling

Indexable Thread Milling Holder ATM60

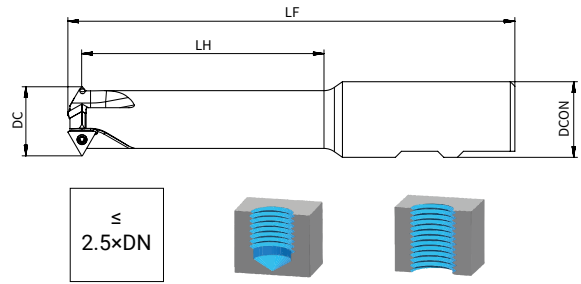

Product code	Dimension (mm)						Z	coolant	No. of inserts	Insert code
	DN	Pmax mm	DC mm	LH mm	LF mm	DCON mm				
ATM60-016-Z03-052-W16R-06	M20	2.5	16	52	108	16	3		3	TM-06
ATM60-019-Z03-055-W20R-06	M24	3	19	55	115	20	3		3	TM-06
ATM60-024-Z03-080-W25R-09	M30	3.5	24	80	148	25	3		3	TM-09
ATM60-030-Z03-090-W32R-09	M36	4	30	90	162	32	3		3	TM-09
ATM60-035-Z03-110-W32R-11	M42	4.5	35	110	180	32	3		3	TM-11
ATM60-040-Z03-125-W40R-14	M48	5	40	125	208	40	3		3	TM-14
ATM60-044-Z03-150-W40R-14	M56	5.5	44	150	232	40	3		3	TM-14

Note: With internal coolant
 Without internal coolant

Dimension (mm)	Spare parts		
D mm	Screw	Wrench	Locking torque
16-19	SP020043	DT-TP06	0.6Nm
24-30	SP022049H	DT-TP07	0.9Nm
35	SP025066	DT-TP07	0.9Nm
40-44	SP030077	DT-TP09	2.0Nm

Thread Milling Insert TM60G, TM55G

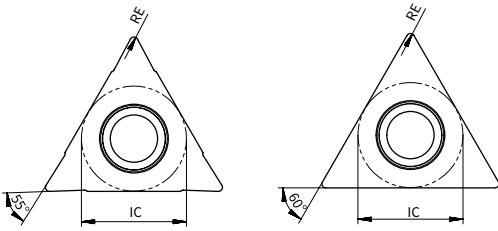

Inserts	Product code	RE mm	Pitch P mm	Pitch P inch	Grade
					AP320U
	TM60G-06T101E-MU1	0.1	1.5-2.9	18-9	●
	TM60G-06T102E-MU1	0.2	3	8	●
	TM60G-090201E-MU1	0.1	1.5-2.9	18-9	●
	TM60G-090202E-MU1	0.2	3.0-4.0	8-6	●
	TM60G-110201E-MU1	0.1	1.5-2.9	18-9	●
	TM60G-110202E-MU1	0.2	3.0-4.5	8-6	●
	TM60G-140301E-MU1	0.1	1.5-2.9	18-9	●
	TM60G-140302E-MU1	0.2	3.0-5.0	8-5	●
	TM60G-140304E-MU1	0.4	5.0-6.0	5-4	●
	TM55G-090202E-MU1	0.2		11	●
TM55G-140302E-MU1	0.2		11	●	

Marked: ● Stocked ○ Limited-stock

Tool Selection

Metric thread

Tool holder code	D mm	Insert	Coarse pitch	Fine pitch
ATM60-016-Z03-052-W16R-06	16	TM60G-06T101	M20; M22;	M20X1.5; M20X2;
ATM60-019-Z03-055-W20R-06	19	TM60G-06T101		M22X1.5; M22X2; M24X1.5; M24X2; M25X1.5; M26X1.5;
		TM60G-06T102	M24; M27;	
ATM60-024-Z03-080-W25R-09	24	TM60G-090201		M27X1.5; M27X2; M28X1.5; M28X2; M30X1.5; M30X2; M32X1.5; M32X2; M33X1.5; M33X2;
		TM60G-090202	M30; M33;	
ATM60-030-Z03-090-W32R-09	30	TM60G-090201		M34X1.5; M35X1.5; M36X1.5; M36X2; M38X1.5; M39X1.5; M39X2;
		TM60G-090202	M36; M39;	M36X3; M39X3;
ATM60-035-Z03-110-W32R-11	35	TM60G-110201		M39X1.5; M39X2; M40X1.5; M40X2; M42X1.5; M42X2;
		TM60G-110202	M42; M45;	M40X3; M42X3;
ATM60-040-Z03-125-W40R-14	40	TM60G-140301		M45X1.5; M45X2; M48X2;
		TM60G-140302	M48; M52;	M45X3; M48X3;
ATM60-044-Z03-150-W40R-14	44	TM60G-140301		M50X1.5; M50X2; M52X1.5; M52X2; M56X1.5; M56X2; M58X1.5; M60X1.5; M60X2; M64X1.5; M64X2; M68X1.5; M68X2;
		TM60G-140302		M50X3; M52X3; M56X3; M60X3; M64X3; M68X3;
		TM60G-140304	M56; M60; M64; M68;	

Tool Selection

ANSI UN thread

Tool holder code	D mm	Insert	UNC	UNF	UNEF	UN
ATM60-016-Z03-052-W16R-06	16	TM60G-06T101	7/8-9;	3/4-16; 7/8-14; 1-12;		7/8-12; 7/8-16;
		TM60G-06T102				
ATM60-019-Z03-055-W20R-06	19	TM60G-06T101		1-12; 1 1/8-12; 1 1/4-12;	1 1/16-18;	1-16;
		TM60G-06T102	1-8;			1 1/16-8;
ATM60-024-Z03-080-W25R-09	24	TM60G-090201		1 1/8-12; 1 1/4-12;	1 1/8-18; 1 1/4-18;	1 1/8-16; 1 1/4-16;
		TM60G-090202	1 1/8-7; 1 1/4-7; 1 3/8-6;			1 1/8-8; 1 1/4-8;
ATM60-030-Z03-090-W32R-09	30	TM60G-090201		1 3/8-12; 1 1/2-12;	1 3/8-18; 1 1/2-18;	1 3/8-16; 1 1/2-18;
		TM60G-090202	1 1/2-6;			1 3/8-8; 1 1/2-8;
ATM60-035-Z03-110-W32R-11	35	TM60G-110201			1 5/8-18;	1 5/8-12; 1 5/8-16;
		TM60G-110202				1 5/8-6; 1 5/8-8; 1 3/4-6; 1 3/4-8;
ATM60-040-Z03-125-W40R-14	40	TM60G-140301				1 3/4-12; 1 3/4-16; 1 7/8-12; 1 7/8-16;
		TM60G-140302				1 7/8-6; 1 7/8-8;
ATM60-044-Z03-150-W40R-14	44	TM60G-140301				2-12; 2-16; 2 1/8-12; 2 1/8-16; 2 1/4-12; 2 1/4-16; 2 1/2-12; 2 1/2-16;
		TM60G-140302				2-6; 2-8; 2 1/8-6; 2 1/8-8; 2 1/4-6; 2 1/4-8; 2 1/2-6; 2 1/2-8;
		TM60G-140304	2-4.5; 2 1/4-4.5; 2 1/2-4;			

Tool Selection

G-Thread(BSP)

Tool holder code	D mm	Insert	G
ATM60-024-Z03-080-W25R-09	24	TM55G-090202	G1-11; G1 1/8-11; G1 1/4-11;
ATM60-030-Z03-090-W32R-09	30	TM55G-090202	G1 1/8-11; G1 1/4-11; G1 3/8-11; G1 1/2-11;
ATM60-040-Z03-125-W40R-14	40	TM55G-140302	G1 1/2-11; G1 3/4-11;G2-11;
ATM60-044-Z03-150-W40R-14	44	TM55G-140302	G1 3/4-11;G2-11; G2 1/4-11;G2 1/2-11; G3-11;

Indexable Thread Milling Cutting Parameter Recommendation

		Materials				ATM60				
ISO	Material classification	Brinell hardness (HB)	Tensile strength (N/mm ²)	Cutting speed Vc(m/min)	fz(mm) Insert dimension					
					06	09	11/14			
P	Unalloyed steel	C≤0.25%	Annealed	125	428	180	0.3	0.35	0.4	
		0.25<C≤0.55%	Annealed	190	639	180	0.3	0.35	0.4	
		0.25<C≤0.55%	Heat-treated	210	708	180	0.3	0.35	0.4	
		C>0.55%	Annealed	190	639	180	0.3	0.35	0.4	
		C>0.55%	Heat-treated	300	1013	180	0.25	0.3	0.35	
		Free cutting steel (short-chipping)	Annealed	220	745	180	0.3	0.35	0.4	
	Low-alloyed steel	Annealed		175	591	180	0.3	0.35	0.4	
		Heat-treated		300	1013	180	0.3	0.35	0.4	
		Heat-treated		380	1282	130	0.2	0.3	0.35	
		Heat-treated		430	1477	80	0.15	0.2	0.3	
	High-alloyed steel and high-alloyed tool steel	Annealed		200	675	180	0.25	0.35	0.4	
		Hardened and tempered		300	1013	180	0.25	0.35	0.4	
		Hardened and tempered		400	1361	130	0.25	0.3	0.35	
	Stainless steel	Ferritic/martensitic, annealed		200	675	180	0.25	0.3	0.35	
Martensitic, heat-treated		330	1114	130	0.25	0.3	0.35			
M	Stainless steel	Austenitic, quench hardened		200	675	180	0.2	0.3	0.35	
		Austenitic, precipitation hardened (PH)		300	1013	130	0.2	0.3	0.35	
		Austenitic/ferritic, duplex		230	778	80	0.2	0.3	0.35	
K	Malleable cast iron	Ferritic		200	400	180	0.3	0.35	0.4	
		Pearlitic		260	700	180	0.3	0.35	0.4	
	Grey cast iron	Low tensile strength		180	200	250	0.3	0.35	0.4	
		High tensile strength/austenitic		245	350	180	0.3	0.35	0.4	
	Cast iron with spheroidal graphite	Ferritic		155	400	180	0.3	0.35	0.4	
		Pearlitic		265	700	180	0.3	0.35	0.4	
		GGV(CGI)		230	400	180	0.3	0.35	0.4	
N	Wrought aluminium alloys	non-aging		30	-					
		aged		100	340					
	Cast aluminium alloys	≤ 12% Si, non-aging		75	260					
		≤ 12% Si, aged		90	310	200	0.3	0.35	0.4	
		> 12% Si, non-aging		130	450	240	0.3	0.35	0.4	
	Magnesium alloys				70	250				
	Copper and copper alloys (bronze/brass)	Unalloyed, electrolytic copper		100	340					
Brass, bronze, red brass		90	310							
Cu alloys, short-chip		110	380							
High tensile, Ampco alloy		300	1010							
S	Heat-resistant alloys	Fe-based	Annealed	200	680	35	0.2	0.2	0.2	
			Hardened	280	940	20	0.1	0.1	0.1	
		Ni or Co based	Annealed	250	840	35	0.2	0.2	0.2	
			Hardened	350	1180	20	0.1	0.1	0.1	
			Cast	320	1080	30	0.2	0.2	0.2	
	Titanium alloys	Pure titanium		200	680	35	0.2	0.2	0.2	
		α and β alloys, hardened		375	1260	35	0.2	0.2	0.2	
		β alloys		410	1400	25	0.2	0.2	0.2	
	Tungsten alloys				300	1010	35	0.2	0.2	0.2
	Molybdenum alloys				300	1010	35	0.2	0.2	0.2
H	Hardened steel	Hardened and tempered		50HRC		40	0.15	0.2	0.2	
		Hardened and tempered		55HRC						
		Hardened and tempered		60HRC						
	Chilled cast iron	Hardened and tempered		50HRC		40	0.15	0.2	0.2	

The recommended cutting parameters are theoretical values, special applications require adjustment of the recommended values.

ACHTTECK

www.achtecktool.com/en

THE EXPERT OF DIFFICULT MACHINING



CUTTING TOOL CATALOGUE

Tool System	432
Chuck Denomination System	434
Chuck Overview	435
BT Series	436
Power Chuck	436
Collet Chuck	437
Face Milling Cutter Arbor	439
Anti-Vibration Face Milling Cutter Arbor	444
Side Lock Chuck	445
Accessories	446
Reduction Sleeve	446
ER Collet Chuck	447
ER Nut	453
HSK Coolant Tube	455
Solid Carbide Extension	457

Chuck Denomination System

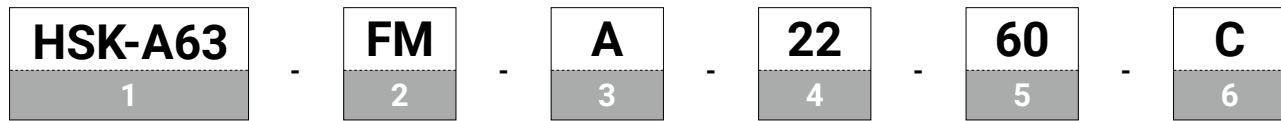

1-Major Spindle Style
HSK-A63 HSK-A100 BT40 BT50

2-Type of Chuck	
Code	Name
HC	Hydraulic Chuck
SF	Shrink Fit Chuck
ER	ER Collet Chuck
SL	Side Lock Chuck
PC	Power Milling cutter Chuck
FM	Face Milling cutter Arbor

3-Distinguishing Code	
Shrink Fit Chuck/ Hydraulic Chuck/ Power Chuck	No mark-----Standard S-----Mini P-----Heavy Duty Design
Side Lock Chuck	B-----Weldon Type E-----Whistle Notch Type
Face milling Cutter Arbor	A-----Common Clamping Screw B-----Clamping with Shim Screw C-----Periphery Clamping Screw D-----Anti-vibration type
ER Collet Chuck	Without-----Standard V-----Tapping Type H-----High speed Type

4-Clamping Diameter D1
D1=22mm

5-Length of Chuck L1
L1=60mm

6-Other Information	
C	Coolant through end face

Chuck Overview

Type	Power Chuck	Collet chuck holder	Face milling cutter arbor	Side lock chuck
Spindle interface standard	JIS B6339	JIS B6339	JIS B6339	JIS B6339
Finishing	●	●	●	
High-speed cutting		●		
Roughing	●	●	●	●
Holding range	6-32	4-25	22-60	20-40
Attention	collet chuck check/ cleaning	collet chuck check/ cleaning	Screw tightened	Screw tightened
Spindle	BT40、BT50	BT40、BT50	BT40、BT50	BT40、BT50
Tool clamping	PC20、PC25、 PC32	ER16、ER20、 ER25、ER32、 ER40	FMA22、FMA27、 FMB32、FMB40、 FMC40、FMC60	SLB20、SLB25、 SLB32、SLB40
Page	P436	P437	P439	P445

Power Chuck

JIS B6339

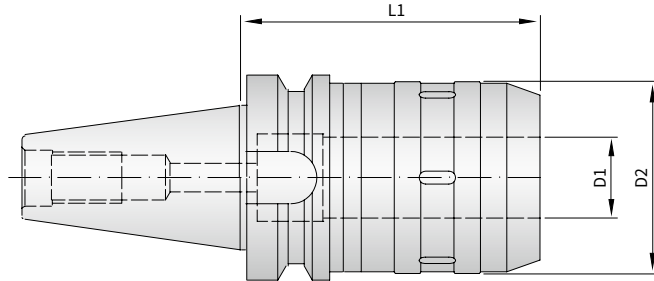

Product code	Stock	Spindle	Dimension (mm)			
			D1	D2	L1	Wrench(selected)
BT40-PC20-80	●	BT40	20	53	80	W-C20
BT40-PC25-90	●	BT40	25	58	90	W-C25
BT40-PC32-105	●	BT40	32	68	105	W-C32
BT50-PC25-90	●	BT50	25	58	90	W-C25
BT50-PC32-105	●	BT50	32	68	105	W-C32

Marked: Wrench and the reduction sleeve can be ordered

●: Stocked ○: Unstocked

Tool combination

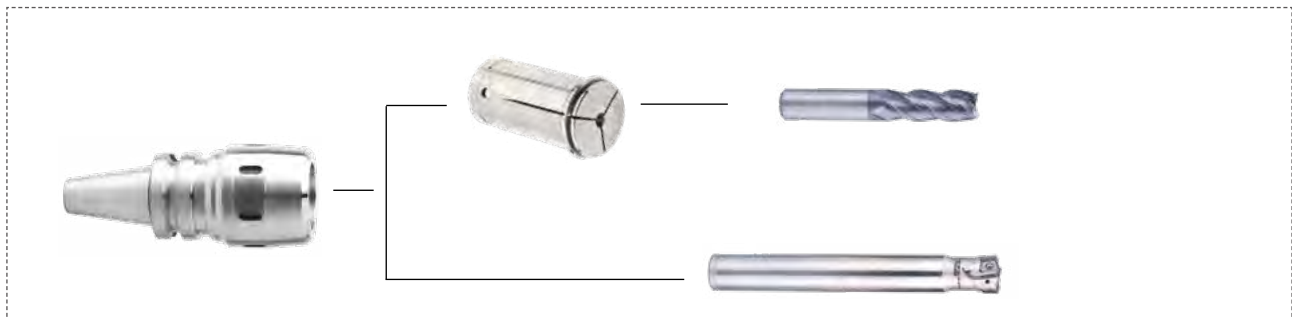

ER Collet Chuck

JIS B6339

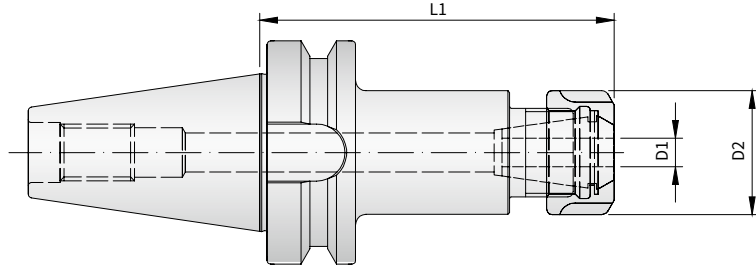

Product code	Stock	Spindle	Dimension (mm)			Nut	Collet(selected)
			D1	D2	L1		
BT40-ER16-70	●	BT40	4-10	28	70	ER16-A	ER16
BT40-ER16-100	●	BT40	4-10	28	100	ER16-A	ER16
BT40-ER16-150	○	BT40	4-10	28	150	ER16-A	ER16
BT40-ER20-70	●	BT40	4-12	34	70	ER20-A	ER20
BT40-ER20-100	●	BT40	4-12	34	100	ER20-A	ER20
BT40-ER20-150	○	BT40	4-12	34	150	ER20-A	ER20
BT40-ER25-70	●	BT40	4-16	42	70	ER25-UM	ER25
BT40-ER25-100	●	BT40	4-16	42	100	ER25-UM	ER25
BT40-ER25-150	○	BT40	4-16	42	150	ER25-UM	ER25
BT40-ER32-70	●	BT40	4-20	50	70	ER32-UM	ER32
BT40-ER32-100	●	BT40	4-20	50	100	ER32-UM	ER32
BT40-ER32-150	○	BT40	4-20	50	150	ER32-UM	ER32

Marked: Wrench and ER collet can be ordered

●: Stocked ○: Unstocked

Tool combination

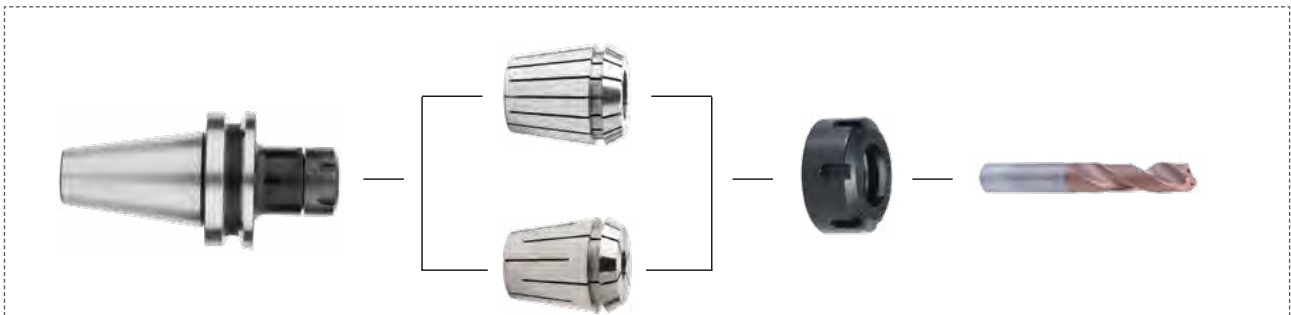

BT series

ER Collet Chuck

JIS B6339

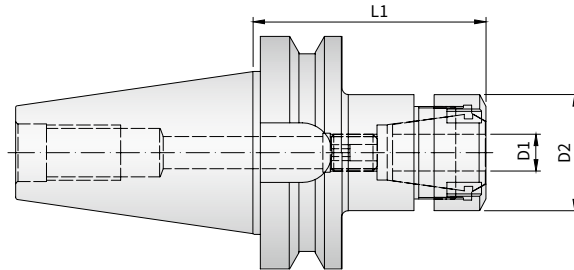

Product code	Stock	Spindle	Dimension (mm)			Nut	Collet(selected)
			D1	D2	L1		
BT50-ER16-70	○	BT50	4-10	28	70	ER16-A	ER16
BT50-ER16-100	●	BT50	4-10	28	100	ER16-A	ER16
BT50-ER16-150	○	BT50	4-10	28	150	ER16-A	ER16
BT50-ER20-70	○	BT50	4-12	34	70	ER20-A	ER20
BT50-ER20-100	●	BT50	4-12	34	100	ER20-A	ER20
BT50-ER20-150	○	BT50	4-12	34	150	ER20-A	ER20
BT50-ER25-100	●	BT50	4-16	42	100	ER25-UM	ER25
BT50-ER25-150	○	BT50	4-16	42	150	ER25-UM	ER25
BT50-ER32-100	●	BT50	4-20	50	100	ER32-UM	ER32
BT50-ER32-150	○	BT50	4-20	50	150	ER32-UM	ER32
BT50-ER40-100	●	BT50	4-26	63	100	ER40-UM	ER40
BT50-ER40-150	○	BT50	4-26	63	150	ER40-UM	ER40
BT50-ER40-200	○	BT50	4-26	63	200	ER40-UM	ER40

Marked: Wrench and ER collet can be ordered

●: Stocked ○: Unstocked

Tool combination

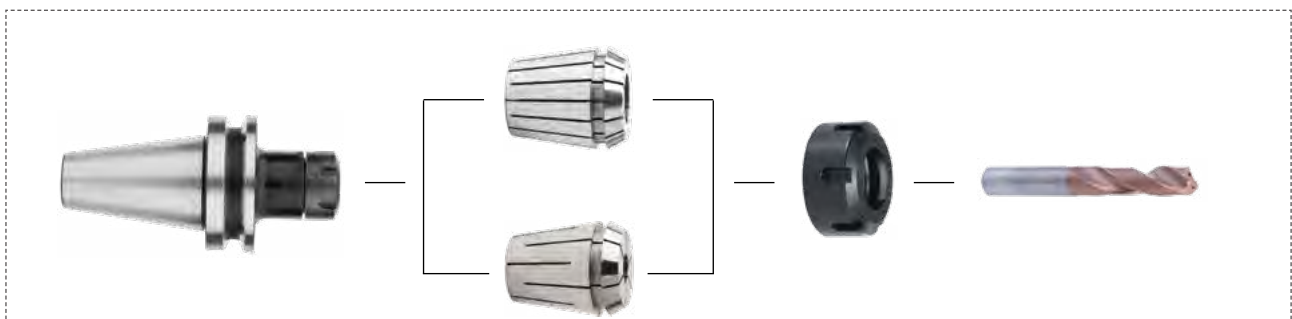

Face Milling Cutter Arbor

JIS B6339

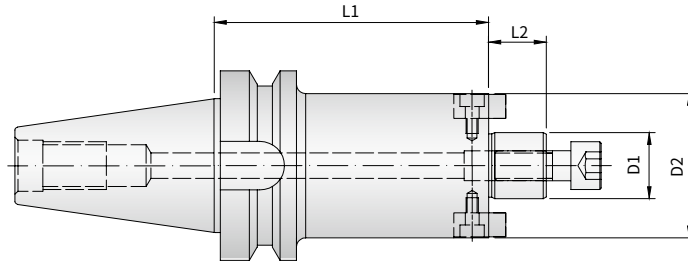

Product code	Stock	Spindle	Dimension (mm)				Cutter clamping screw
			D1	D2	L1	L2	
BT40-FMA22-45	●	BT40	22	48	45	16.5	M10
BT40-FMA22-60	●	BT40	22	48	60	16.5	
BT40-FMA22-100	●	BT40	22	48	100	16.5	
BT40-FMA22-150	○	BT40	22	48	150	16.5	
BT40-FMA27-45	●	BT40	27	60	45	18.5	M12
BT40-FMA27-60	●	BT40	27	60	60	18.5	
BT40-FMA27-100	●	BT40	27	60	100	18.5	
BT40-FMA27-150	○	BT40	27	60	150	18.5	
BT40-FMA27-200	○	BT40	27	60	200	18.5	
BT40-FMB32-60	●	BT40	32	62	60	22	M16
BT40-FMB32-100	●	BT40	32	62	100	22	
BT40-FMB32-150	○	BT40	32	62	150	22	
BT40-FMB32-200	○	BT40	32	62	200	22	
BT40-FMB40-60	●	BT40	40	80	60	23	M20
BT40-FMB40-100	●	BT40	40	80	100	23	
BT40-FMB40-150	○	BT40	40	80	150	23	
BT40-FMB40-200	○	BT40	40	80	200	23	

●: Stocked ○: Unstocked

BT series

Face Milling Cutter Arbor - Coolant Through End Face

JIS B6339

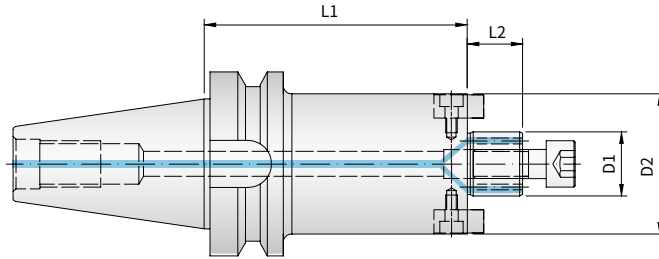

Product code	Stock	Spindle	Dimension (mm)				Internal coolant	Cutter clamping screw
			D1	D2	L1	L2		
BT40-FMA22-60-C	●	BT40	22	48	60	16.5		M10
BT40-FMA22-100-C	○	BT40	22	48	100	16.5		
BT40-FMA27-60-C	●	BT40	27	60	60	18.5		M12
BT40-FMA27-100-C	○	BT40	27	60	100	18.5		
BT40-FMB32-60-C	●	BT40	32	62	60	22		M16
BT40-FMB32-100-C	○	BT40	32	62	100	22		
BT40-FMB40-60-C	●	BT40	40	80	60	23		M20

●: Stocked ○: Unstocked

Face Milling Cutter Arbor

JIS B6339

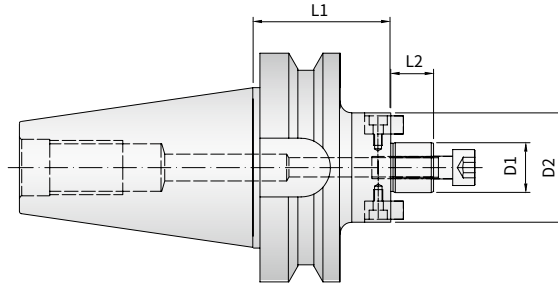

Product code	Stock	Spindle	Dimension (mm)				Cutter clamping screw
			D1	D2	L1	L2	
BT50-FMA22-60	●	BT50	22	48	60	16.5	M10
BT50-FMA22-100	●	BT50	22	48	100	16.5	
BT50-FMA22-150	○	BT50	22	48	150	16.5	
BT50-FMA22-200	○	BT50	22	48	200	16.5	
BT50-FMA27-60	●	BT50	27	60	60	18.5	M12
BT50-FMA27-100	●	BT50	27	60	100	18.5	
BT50-FMA27-150	○	BT50	27	60	150	18.5	
BT50-FMA27-200	○	BT50	27	60	200	18.5	
BT50-FMB32-60	●	BT50	32	78	60	22	M16
BT50-FMB32-100	●	BT50	32	78	100	22	
BT50-FMB32-150	○	BT50	32	78	150	22	
BT50-FMB32-200	○	BT50	32	78	200	22	
BT50-FMB40-60	●	BT50	40	89	60	23	M20
BT50-FMB40-100	●	BT50	40	89	100	23	
BT50-FMB40-150	●	BT50	40	89	150	23	
BT50-FMB40-200	○	BT50	40	89	200	23	

●: Stocked ○: Unstocked

BT series

Face Milling Cutter Arbor Coolant Through End Face

JIS B6339

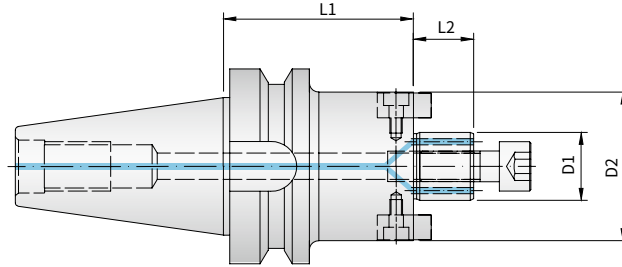

Product code	Stock	Spindle	Dimension (mm)				Internal coolant	Cutter clamping screw
			D1	D2	L1	L2		
BT50-FMA22-60-C	●	BT50	22	48	60	16.5		M10
BT50-FMA22-100-C	○	BT50	22	48	100	16.5		
BT50-FMA27-60-C	●	BT50	27	60	60	18.5		M12
BT50-FMA27-100-C	○	BT50	27	60	90	18.5		
BT50-FMB32-60-C	●	BT50	32	78	60	22		M16
BT50-FMB32-100-C	○	BT50	32	78	100	22		
BT50-FMB40-60-C	●	BT50	40	89	60	23		M20
BT50-FMB40-100-C	○	BT50	40	89	100	23		

●: Stocked ○: Unstocked

Face Milling Cutter Arbor for Big Diameter Cutter

JIS B6339

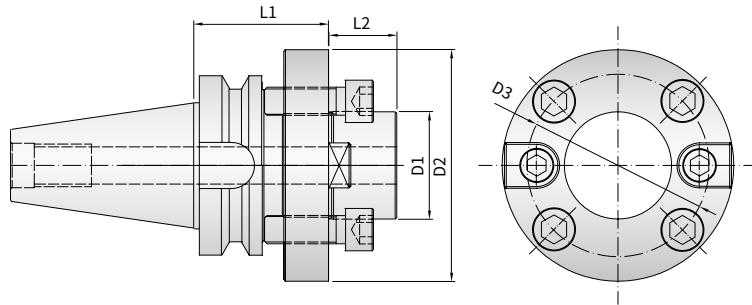

Product code	Stock	Spindle	Dimension (mm)					Cutter clamping screw
			D1	D2	D3	L1	L2	
BT50-FMC40-60	●	BT50	40	98	66.7	60	23	4*M12
BT50-FMC40-100	●	BT50	40	98	66.7	100	23	
BT50-FMC40-150	○	BT50	40	98	66.7	150	23	
BT50-FMC60-75	●	BT50	60	140	101.6	75	25	4*M16

●: Stocked ○: Unstocked

Anti-Vibration Face Milling Cutter Arbor

JIS B6339

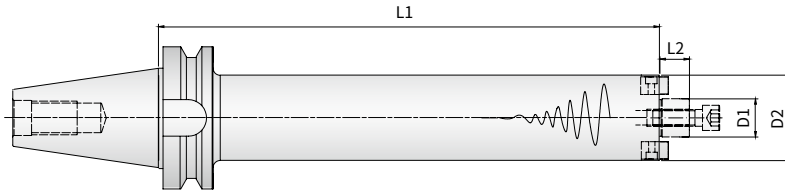

Product code	Stock	Spindle	Dimension (mm)				Weight (Kg)
			D1	D2	L1	L2	
BT50-FMD22-300-D48	○	BT50	22	48	300	18	6.6
BT50-FMD22-350-D48	○	BT50	22	48	350	18	7.25
BT50-FMD22-400-D48	○	BT50	22	48	400	18	7.95
BT50-FMD22-300-D58	○	BT50	22	58	300	18	7.5
BT50-FMD22-400-D58	○	BT50	22	58	400	18	9.3
BT50-FMD22-500-D58	○	BT50	22	58	500	18	11
BT50-FMD27-300-D58	○	BT50	27	58	300	20	7.6
BT50-FMD27-400-D58	○	BT50	27	58	400	20	9.3
BT50-FMD27-500-D58	○	BT50	27	58	500	20	11
BT50-FMD27-300-D78	○	BT50	27	78	300	20	5.75
BT50-FMD27-400-D78	○	BT50	27	78	400	20	11
BT50-FMD27-500-D78	○	BT50	27	78	500	20	13.4
BT50-FMD32-300-D78	○	BT50	32	78	300	21	8.9
BT50-FMD32-400-D78	○	BT50	32	78	400	21	11.2
BT50-FMD32-500-D78	○	BT50	32	78	500	21	13.5

●: Stocked ○: Unstocked

Side Lock Chuck, Weldon Type

JIS B6339

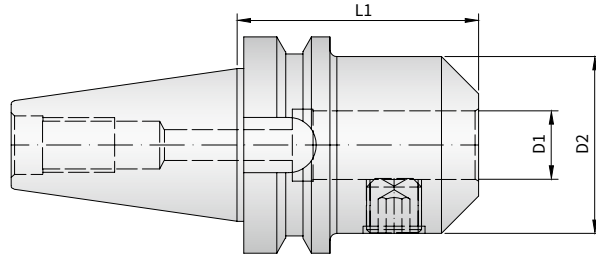

Product code	Stock	Spindle	Dimension (mm)		
			D1	D2	L1
BT40-SLB20-63	●	BT40	20	52	63
BT40-SLB25-100	●	BT40	25	65	100
BT40-SLB32-100	●	BT40	32	72	100
BT50-SLB20-80	●	BT50	20	52	80
BT50-SLB25-100	●	BT50	25	65	100
BT50-SLB32-105	●	BT50	32	72	105
BT50-SLB40-115	●	BT50	40	80	115

●: Stocked ○: Unstocked

Sleeve for Power Chuck
Clamping precision within 0.01mm

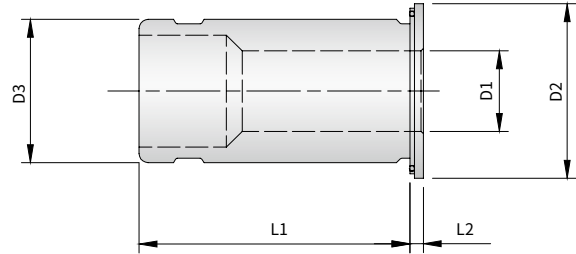

Product code	Stock	Dimension (mm)				
		D1	D3	D2	L1	L2
C25-6	●	6	25	30	63	2.5
C25-8	●	8	25	30	63	2.5
C25-10	●	10	25	30	63	2.5
C25-12	●	12	25	30	63	2.5
C25-16	●	16	25	30	63	2.5
C25-20	●	20	25	30	63	2.5
C32-6	●	6	32	38	70	4
C32-8	●	8	32	38	70	4
C32-10	●	10	32	38	70	4
C32-12	●	12	32	38	70	4
C32-14	●	14	32	38	70	4
C32-16	●	16	32	38	70	4
C32-18	●	18	32	38	70	4
C32-20	●	20	32	38	70	4
C32-25	●	25	32	38	70	4

Marked: Used in power chuck

●: Stocked ○: Unstocked

ER Collet

ER collet chuck features: High precision, long tool life

- Material: JIS-SUJ2
- Hardness: 46-50HRC
- The grinding process, was used in the collet grooves, which is suitable for high-speed machining
- Ground internal dia. , external dia. and end face to achieve high precision at Ra0.4
- Environmental friendly coating to enhance the surface hardness, wear resistance and cleanness with a more constant precision, more smooth surface, better result in rust and corrosion prevention

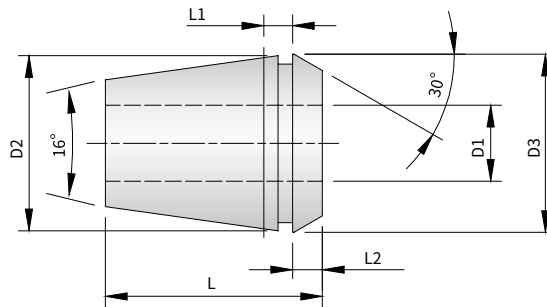

Product code	Dimension (mm)					
	D1	D2	D3	L	L1	L2
ER16	4-10	16	17	27.5	6.26	4
ER20	4-13	20	21	31.5	6.36	4.8
ER25	4-16	25	26	34	6.66	5
ER32	4-20	32	33	40	7.16	5.5
ER40	4-26	40	41	46	7.66	7

Marked: Used in ER collet chuck

ER collet handling

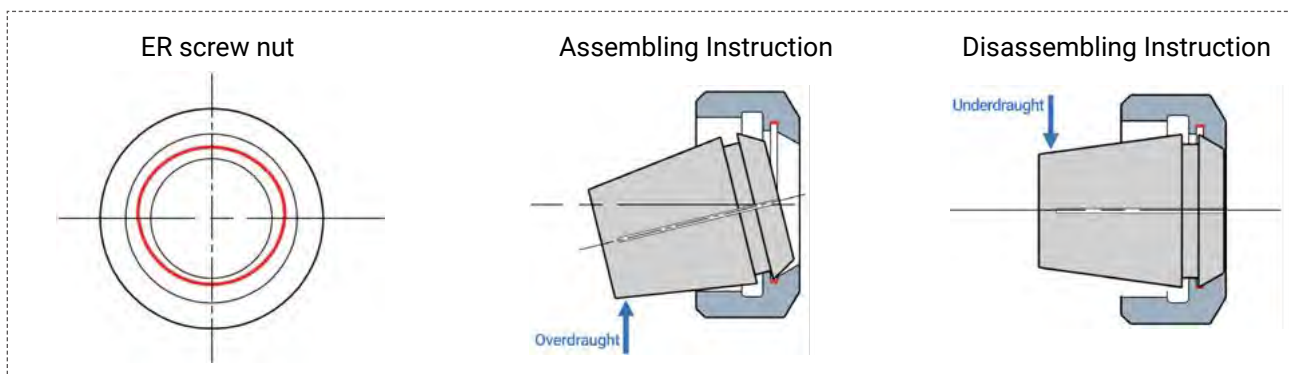

ER Collet

Clamping precision within 0.008mm

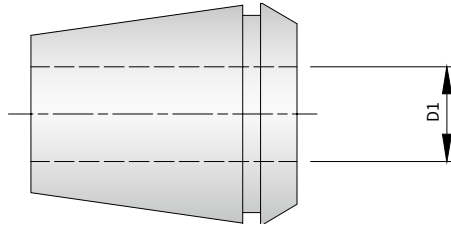

ER16		ER20		ER25		ER32		ER40	
Product code	D1	Product code	D1	Product code	D1	Product code	D1	Product code	D1
ER16-4	4-3	ER20-4	4-3	ER25-4	4-3	ER32-4	4-3	ER40-4	4-3
ER16-6	6-5	ER20-6	6-5	ER25-6	6-5	ER32-6	6-5	ER40-6	6-5
ER16-8	8-7	ER20-8	8-7	ER25-8	8-7	ER32-8	8-7	ER40-8	8-7
ER16-10	10-9	ER20-10	10-9	ER25-10	10-9	ER32-10	10-9	ER40-10	10-9
		ER20-12	12-11	ER25-12	12-11	ER32-12	12-11	ER40-12	12-11
				ER25-14	14-13	ER32-14	14-13	ER40-14	14-13
				ER25-16	16-15	ER32-16	16-15	ER40-16	16-15
						ER32-18	18-17	ER40-18	18-17
						ER32-20	20-19	ER40-20	20-19
								ER40-25	25-24

Marked: Used in ER collet chuck

High Precision ER Collet

Clamping precision within 0.005mm

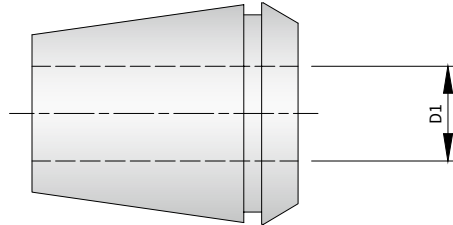

ER16		ER20		ER25		ER32	
Product code	D1	Product code	D1	Product code	D1	Product code	D1
ER16-4A	4-3	ER20-4A	4-3	ER25-4A	4-3	ER32-4A	4-3
ER16-6A	6-5	ER20-6A	6-5	ER25-6A	6-5	ER32-6A	6-5
ER16-8A	8-7	ER20-8A	8-7	ER25-8A	8-7	ER32-8A	8-7
ER16-10A	10-9	ER20-10A	10-9	ER25-10A	10-9	ER32-10A	10-9
		ER20-12A	12-11	ER25-12A	12-11	ER32-12A	12-11
				ER25-14A	14-13	ER32-14A	14-13
				ER25-16A	16-15	ER32-16A	16-15
						ER32-18A	18-17
						ER32-20A	20-19

Marked: Used in ER collet chuck

ER Sealing Collet

Clamping precision within 0.008mm

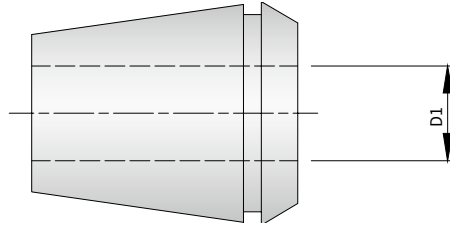

ER16		ER20		ER25		ER32	
Product code	D1	Product code	D1	Product code	D1	Product code	D1
ER16-4C	4-3.9	ER20-4C	4-3.9	ER25-4C	4-3.9	ER32-4C	4-3.9
ER16-6C	6-5.5	ER20-6C	6-5.5	ER25-6C	6-5.5	ER32-6C	6-5.5
ER16-8C	8-7.5	ER20-8C	8-7.5	ER25-8C	8-7.5	ER32-8C	8-7.5
ER16-10C	10-9.5	ER20-10C	10-9.5	ER25-10C	10-9.5	ER32-10C	10-9.5
		ER20-12C	12-11.5	ER25-12C	12-11.5	ER32-12C	12-11.5
				ER25-14C	14-13.5	ER32-14C	14-13.5
				ER25-16C	16-15.5	ER32-16C	16-15.5
						ER32-18C	18-17.5
						ER32-20C	20-19.5

Marked: Used in ER collet chuck

High Precision ER Sealing Collet
Clamping precision within 0.005mm

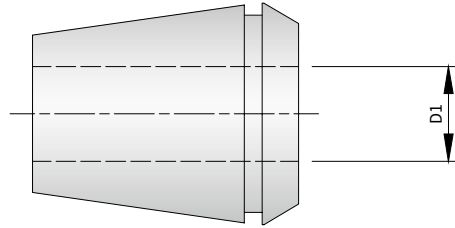

ER16		ER20		ER25		ER32	
Product code	D1	Product code	D1	Product code	D1	Product code	D1
ER16-4CA	4-3.9	ER20-4CA	4-3.9	ER25-4CA	4-3.9	ER32-4CA	4-3.9
ER16-6CA	6-5.5	ER20-6CA	6-5.5	ER25-6CA	6-5.5	ER32-6CA	6-5.5
ER16-8CA	8-7.5	ER20-8CA	8-7.5	ER25-8CA	8-7.5	ER32-8CA	8-7.5
ER16-10CA	10-9.5	ER20-10CA	10-9.5	ER25-10CA	10-9.5	ER32-10CA	10-9.5
		ER20-12CA	12-11.5	ER25-12CA	12-11.5	ER32-12CA	12-11.5
				ER25-14CA	14-13.5	ER32-14CA	14-13.5
				ER25-16CA	16-15.5	ER32-16CA	16-15.5
						ER32-18CA	18-17.5
						ER32-20CA	20-19.5

Marked: Used in ER collet chuck

ER Collet for Tapping

8 sluts, clamping precision within 0.02mm

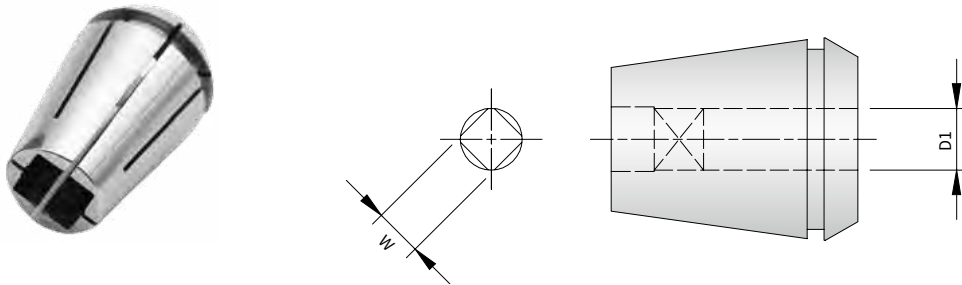

Product code			D1	W	Thread specification	General standard
ER20	ER25	ER32				
ER20G-4.5W34	ER25G-4.5W34		4.5	3.4	M4 M6	DIN371 DIN376
ER20G-6W49	ER25G-6W49	ER32G-6W49	6	4.9	M5/M6 M8	DIN371 DIN376
ER20G-7W55	ER25G-7W55	ER32G-7W55	7	5.5	M10	DIN376
ER20G-8W62	ER25G-8W62	ER32G-8W62	8	6.2	M8	DIN371
ER20G-9W70	ER25G-9W70	ER32G-9W70	9	7	M12	DIN376
ER20G-10W80	ER25G-10W80	ER32G-10W80	10	8	M10	DIN371
	ER25G-11W90	ER32G-11W90	11	9	M14	DIN376
	ER25G-12W90	ER32G-12W90	12	9	M16	DIN376
		ER32G-14W110	14	11	M18	DIN376
		ER32G-16W120	16	12	M20	DIN376
		ER32G-18W145	18	14.5	M22 M24	DIN376 DIN376

Marked: Used in ER collet chuck

ER Screw Nut

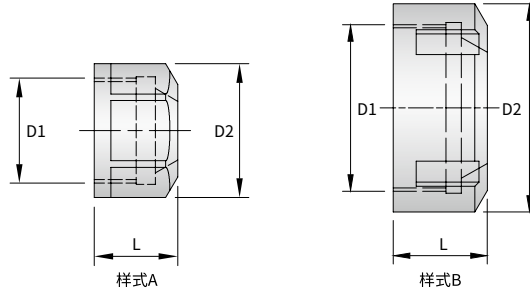

Product code	Dimension (mm)			Form	Suitable for collet
	D1	D2	L		
ER16-A	M22X1.5	28	17.5	A	ER16
ER20-A	M25X1.5	34	19	A	ER20
ER25-UM	M32X1.5	42	20	B	ER25
ER32-UM	M40X1.5	50	23	B	ER32
ER40-UM	M50X1.5	63	26	B	ER40

Marked: Used in ER collet chuck, ER collet chuck has a screw nut

ER Screw Nut for Internal Coolant

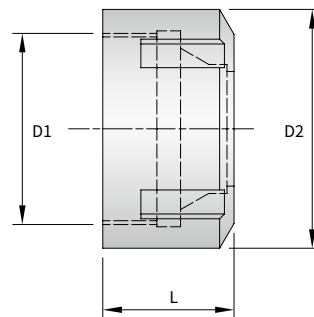

Product code	Dimension (mm)			Suitable for collet
	D1	D2	L	
ER20-AC	M25X1.5	34	24	ER20
ER25-UMC	M32X1.5	42	25	ER25
ER32-UMC	M40X1.5	50	28	ER32
ER40-UMC	M50X1.5	63	30.5	ER40

Marked: Match with sealing washer, used for tap with internal coolant

Sealing Washer

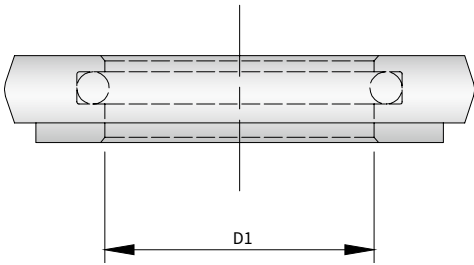

Clamping range	Product code			
	ER20	ER25	ER32	ER40
4.0-3.5	RC20-4	RC25-4	RC32-4	
5.0-4.5	RC20-5	RC25-5	RC32-5	
6.0-5.5	RC20-6	RC25-6	RC32-6	RC40-6
6.5-6.0	RC20-6.5	RC25-6.5	RC32-6.5	
7.0-6.5	RC20-7	RC25-7	RC32-7	
8.0-7.5	RC20-8	RC25-8	RC32-8	RC40-8
9.0-8.5	RC20-9	RC25-9	RC32-9	
10.0-9.5	RC20-10	RC25-10	RC32-10	RC40-10
12.0-11.5		RC25-12	EC32-12	RC40-12
14.0-13.5		RC25-14	RC32-14	RC40-14
16.0-15.5			RC32-16	RC40-16
18.0-17.5			RC32-18	RC40-18
20.0-19.5			RC32-20	RC40-20
22.0-21.5				RC40-22
24.0-23.5				RC40-24
25.0-24.5				RC40-25

Marked: Used in sealing ER screw nut

HSK Coolant Bolt

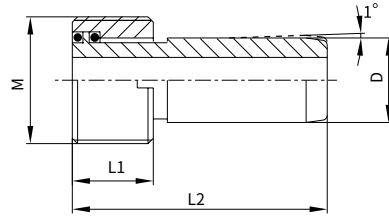
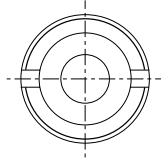

Product code	Stock	Spindle	Dimension (mm)			
			M	D	L1	L2
CT-HSK63	●	HSK-63	M18×1	12	11.5	36.6
CT-HSK100	●	HSK-100	M24×1.5	16	15.5	44.2

●: Stocked ○: Unstocked

Steel Extension

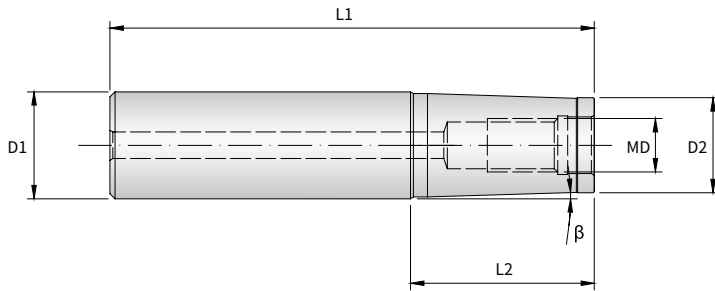

Product code	Stock	Coupling	Dimension (mm)					
			D1	D2	MD	L1	L2	β
C16S-M08-80-T	●	C16	16	14.5	M08	80	20	3°12'
C16S-M08-100-T	●	C16	16	14.5	M08	100	40	1°4'
C20S-M10-100-T	●	C20	20	18	M10	100	40	1°53'
C20S-M10-120-T	●	C20	20	18	M10	120	50	1°
C25S-M12-110-T	●	C25	25	22.5	M12	110	30	2°36'
C25S-M12-130-T	●	C25	25	22.5	M12	130	50	1°18'
C32S-M16-125-T	●	C32	32	28.5	M16	125	35	3°15'
C32S-M16-145-T	●	C32	32	28.5	M16	145	55	1°48'

●: Stocked ○: Unstocked

Solid Carbide Extension

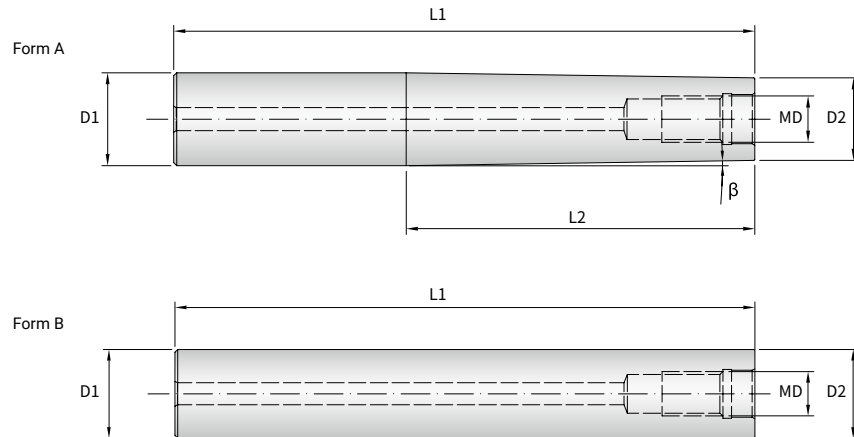

Product code	Stock	Coupling	Dimension (mm)						Form
			D1	D2	MD	L1	L2	β	
C20C-M08-100-T	●	C20	20	14.5	M08	100	40	3°30'	A
C20C-M08-150-T	●	C20	20	14.5	M08	150	77	1°45'	A
C16C-M08-200-T	●	C16	16	15.5	M08	200	150	43'	A
C20C-M10-100-T	●	C20	20	18.5	M10	100	40	43'	A
C25C-M10-150-T	●	C25	25	18.5	M10	150	70	1°43'	A
C20C-M10-150-T	●	C20	20	18.5	M10	150	90	19'	A
C20C-M10-200-T	●	C20	20	18.5	M10	200	140	12'	A
C32C-M12-200-T	●	C32	32	23.5	M12	200	120	1°45'	A
C32C-M16-200-T	●	C25	32	29	M16	200	120	30'	A
C32C-M16-250-T	●	C32	32	29	M16	250	170	28'	A
C32C-M16-300-T	●	C32	32	29	M16	300	200	28'	A
C16C-M08-100	●	C16	16	16	M08	100			B
C16C-M08-150	●	C16	16	16	M08	150			B
C16C-M08-200	●	C16	16	16	M08	200			B
C20C-M10-100	●	C20	20	20	M10	100			B
C20C-M10-150	●	C20	20	20	M10	150			B
C20C-M10-200	●	C20	20	20	M10	200			B
C20C-M10-250	●	C20	20	20	M10	250			B
C25C-M12-100	●	C25	25	25	M12	100			B
C25C-M12-150	●	C25	25	25	M12	150			B
C25C-M12-200	●	C25	25	25	M12	200			B
C25C-M12-250	●	C25	25	25	M12	250			B
C25C-M12-300	●	C25	25	25	M12	300			B
C32C-M16-150	●	C32	32	32	M16	150			B
C32C-M16-200	●	C32	32	32	M16	200			B
C32C-M16-250	●	C32	32	32	M16	250			B
C32C-M16-300	●	C32	32	32	M16	300			B

●: Stocked ○: Unstocked

Solid Carbide Extension

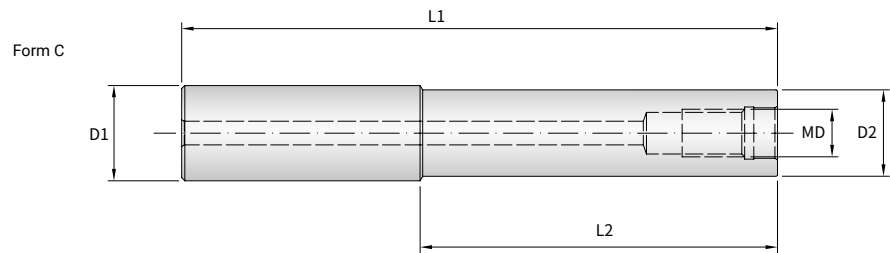

Product code	Stock	Coupling	Dimension (mm)						Form
			D1	D2	MD	L1	L2	β	
C16C-M08-100-R	●	C16	16	15.5	M08	100	40		C
C16C-M08-150-R	●	C16	16	15.5	M08	150	90		C
C16C-M08-200-R	●	C16	16	15.5	M08	200	120		C
C20C-M10-100-R	●	C20	20	19.5	M10	100	40		C
C20C-M10-150-R	●	C20	20	19.5	M10	150	90		C
C20C-M10-200-R	●	C20	20	19.5	M10	200	140		C
C20C-M10-250-R	●	C20	20	19.5	M10	250	180		C
C25C-M12-100-R	●	C25	25	24	M12	100	25		C
C25C-M12-150-R	●	C25	25	24	M12	150	70		C
C25C-M12-200-R	●	C25	25	24	M12	200	120		C
C25C-M12-250-R	●	C25	25	24	M12	250	180		C
C25C-M12-300-R	●	C25	25	24	M12	300	220		C
C32C-M16-100-R	●	C32	32	29	M16	100	30		C
C32C-M16-150-R	●	C32	32	29	M16	150	70		C
C32C-M16-200-R	●	C32	32	29	M16	200	120		C
C32C-M16-250-R	●	C32	32	29	M16	250	170		C
C32C-M16-300-R	●	C32	32	29	M16	300	220		C

Marked: Used in vertical machine, to get better result, please make a comprehensive valuation and selection based on machine toughness, tool overhang, machining parameters and etc.

●: Stocked ○: Unstocked

ACHTECK

www.achtecktool.com/en







THE EXPERT OF DIFFICULT MACHINING



CUTTING TOOL CATALOGUE

Technical Information	460
Turning Insert Common Failure Mode & Solutions	462
General Turning & Grooving	463
Swiss Machine Information	466
Milling	471
Round Tool Common Failure Mode & Solutions	477
Turning & Milling Grade Conversion Table	481
Turning Chip Breaker Conversion Table	486
General Formula	488
Hardness Conversion Table	491
Material Conversion Table	493

Turning Insert Common Failure Mode & Solutions

Failures	Picture	Analysis	Solution
Flank wear		<ul style="list-style-type: none"> • Tool material is too soft • Excessive cutting speed • Too small clearance angle • Too low feed rate • Insufficient cooling 	<ul style="list-style-type: none"> • Choose high wear-resistant insert grade • Reduce cutting speed • Enlarge clearance angle • Increase feed rate
Crater wear		<ul style="list-style-type: none"> • Tool material is too soft • Excessive cutting speed • Excessive feed rate 	<ul style="list-style-type: none"> • Choose high wear-resistant insert grade • Reduce cutting speed • Reduce feed rate • Increase the flow of coolant
Chipping		<ul style="list-style-type: none"> • Tool material is too hard • Too low cutting edge strength 	<ul style="list-style-type: none"> • Choose tougher grade • Enhance cutting edge strength
Plastic deformation		<ul style="list-style-type: none"> • Tool material is too soft • Too fast cutting speed • Excessive cutting depth & feed rate • Insufficient cooling 	<ul style="list-style-type: none"> • Choose high wear-resistant insert grade • Reduce cutting speed • Reduce cutting depth & feed rate • Choose good thermal conductivity grade • Increase the flow of coolant
Built-up edge		<ul style="list-style-type: none"> • Too low cutting speed • Cutting edge not sharp • Unsuitable grade • Insufficient cooling 	<ul style="list-style-type: none"> • Increase cutting speed • Choose sharp geometry • Choose less adhesion grade • Increase the flow of coolant
Mechanical wear		<ul style="list-style-type: none"> • Excessive feed rate and cutting depth • Vibration 	<ul style="list-style-type: none"> • Choose tougher grade • Choose a smaller approach angle • Choose bigger corner radius • Change to high rigidity holder
Thermal cracking		<ul style="list-style-type: none"> • Excessive cutting heat change on edge 	<ul style="list-style-type: none"> • Choose dry cutting or adequate cooling • Choose tougher grade
Notch wear		<ul style="list-style-type: none"> • Excessive feed rate & cutting speed • Tool material is too soft 	<ul style="list-style-type: none"> • Choose high wear-resistance grade • Select a small entering angle • Reduce cutting speed
Coating peeling		<ul style="list-style-type: none"> • Sticky chip on the cutting edge • Chip evacuation failure 	<ul style="list-style-type: none"> • Enlarge rake angle for a sharp edge • Use chip breaker with bigger chip space

Negative and Positive Insert Comparison

Negative insert

- Double/single sided
- High strength edge
- Zero clearance angle
- First choice for external turning
- For heavy cutting conditions

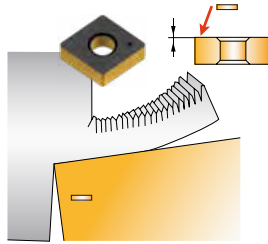

Positive insert

- Single sided
- Low cutting forces
- With clearance angle
- 1st choice for boring and turning on slender parts

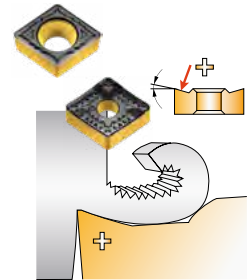

Effects of Approach Angle

Approach angle K_r is the angle between cutting edge and feed direction. It's an important angle in turning that will affect:

- Chip formation
- Cutting force direction
- Cutting edge length

Large Approach Angle

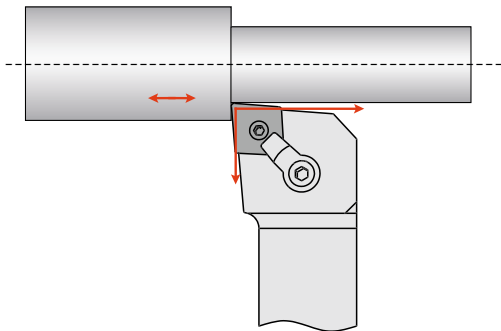

- Cutting forces along with axis, less tendency for vibration.
- Can turn against the shoulder
- Higher cutting forces at the entrance and exit of cut
- It is easy to get notching wear in heat resistant alloy and hard materials

Small Approach Angle

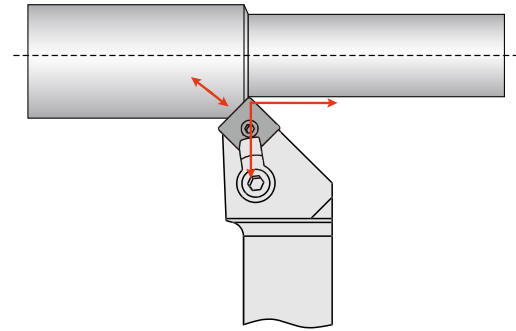

- Reduced the load on the cutting edge.
- Produced a thinner chip, higher feed rate can be used
- Reduced notch wear
- Cannot turn against a shoulder.
- Forces are directed to both axial and radial-vibration tendencies.

Insert Shape

Insert shape should be selected according to the approach angle accessibility of the tool. The largest point angle should be applied to get insert strength and reliability.

Larger point angle and higher cutting edge strength to the left.

Higher edge accessibility and operational versatility to the right.

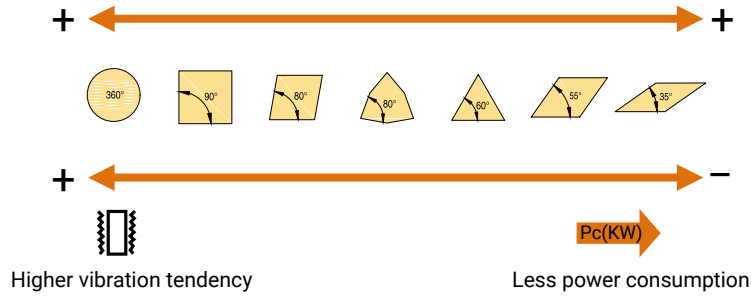

Factors affecting insert shape selection

Insert shape	R	S 90°	C 80°	W 80°	T 60°	D 55°	V 35°
Roughing (strength)	●	●	●	▲	▲		
Light roughing/semi finishing (number of cutting edges)		▲	●	●	●	●	
Finishing (number of cutting edges)			▲	▲	●	●	●
Vibration tendency				▲	●	●	●
Longitudinal turning (feed direction)			●	▲	▲	●	●
Profiling (accessibility)			▲	▲	▲	●	●
Facing (feed direction)	▲	●	●	●	▲	▲	
Operational versatility	▲		●	▲	▲	●	▲
Limited machine power			▲	▲	●	●	●
Hard material	●	●					
Interrupted machining	●	●	▲	▲	▲		
Large approach angle			●	●	●	●	
Small approach angle	●	●		●	●		

Marked: ● Most suitable ▲ Suitable

C-style 80° inserts are frequently used as it's suitable for the most applications.

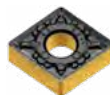

Application Tips for Parting off and Grooving

Single grooving

- Single grooving is the most economical and productive method for machining grooves.
- GS chip breaker has width tolerance of +/- 0.02mm, and works well at low feed.

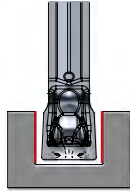

Ramping style grooving

- Ramping style grooving avoids vibration and minimizes radial force. This method can achieve best chip control and reduce notch wear during machining heat resistant alloys
- Higher feed rate can be applied to profiling RM or RA geometry to achieve higher stability and productivity.
- Note: Ramping style grooving doubled the number of passes

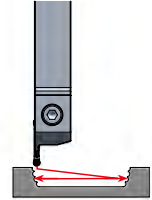

Chamfered corners

- In case of producing high quality grooves, usually the corners on the insert can be used for chamfering. For example, a finish grooving insert is used to chamfer, as per illustration A
- A better way to make grooves with chamfer in mass production is to order a Tailor Made insert with the exact chamfer form as per illustration B.

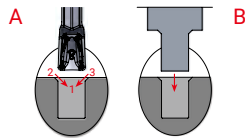

flatness of the groove bottom

- In case of machining radial grooves, sometimes the flatness of the groove bottom is required.
- Generally, GS, TM, G chip breakers are used to machine completely flat bottom grooves.

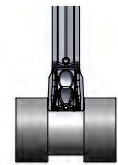

Multiple grooving

- It's the best method for rough grooving when groove depth is bigger than groove width.
- Multiple grooving will improve chip flow and increase tool life.
- Ring's width is generally 0.6-0.8 times insert's width.

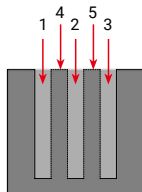

Plunge turning

- TS and TM chip breaker can be used for plunge turning and ramping, as the insert design is suitable for axial and radial feed.
- In case of turning axially, depth should not exceed 0.75 x insert width.

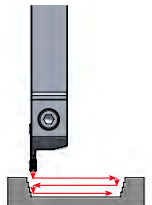

CITIZEN

Cincom product series

product	Tool size (Gang-Type)	No	Tool size(Turret-Type)	No	Guide-bushing(D)	Max.Machining Dia.(D)
A12	10×10×100	5			∅19.05/∅20	∅12
A16	10×10×100	5			∅19.05/∅20	∅16
A20	12×12×120	5-7			∅25.4	∅20
A25	12×12×120	5-6			∅25.4	∅25
A32	16×16×150				∅25.4	∅32
B12/B12E	10×10×100	5			∅19.05/∅20	∅12
B16E	10×10×100	5			∅19.05/∅20	∅16
B20	12×12×120	6			∅19.05/∅20	∅20
BL12	10×10×60-120	5			∅20	∅12
BL20	12×12×120	7			∅20	∅20
BL25	12×12×120	7			∅20	∅25
C12	10×10×120	6			∅19.05	∅12
C16	10×10×120	6			∅19.05	∅16
C32	16×16×130	5			∅25.4	∅32
E32			16×16×90	20	∅25.4	∅32
F10			10×10×60	10	∅19.05	∅10
F12			10×10×60	10	∅19.05	∅12
F16			10×10×60	10	∅19.05	∅16
F20			16×16×90	10	∅25.4	∅20
F25			16×16×90	10	∅25.4	∅25
FL25			16×16×90	12	∅16	∅25
FL42			16×16×90	12	∅16	∅42
G10			10×10×60	8		∅10
G16			10×10×60	8		∅16
G32			16×16×90	10		∅32
K12/K12E	10×10×100	7			∅20	∅12
L16/K16E	12×12×120	6			∅20	∅16
L10	8×8×100-130	5			∅15.875	∅10
L16/L16E	12×12×130	7			∅19.05	∅16
L20/L20E	12×12×130	7			∅19.05	∅20
L25	16×16×130	5			∅25.4	∅25
L32	16×16×130	5			∅25.4	∅32
M12	10×10×120	5	10×10×60	10	∅19.05	∅12
M16	10×10×120	5	10×10×60	10	∅19.05	∅16
M20	12×12×130	5	16×16×90	10	∅25.4	∅20
M32	16×16×130	5	16×16×90	10	∅25.4	∅32
MSL12	10×10×120		10×10×60	10		∅12
R04	8×8×120	7			∅15.875	∅4
R07	8×8×120	5			∅15.875	∅7
RL02	16×16×60-150	6			∅16/∅20	∅25
RL21	10×10×90				∅19.05	∅35

CITIZEN

Miyano product series

product	Tool size (Gang-Type)	No	Guide-bushing(D)	Max.Machining Dia.(D)
ABX-51TH3	20×20×100	12+12/12	∅25	∅51
ABX-64TH3	20×20×100	12+12/12	∅25	∅64
ABX-51THY	20×20×100	12+12/12	∅20/∅25/∅40	∅51
ABX-64THY	20×20×100	12+12/12	∅20/∅25/∅40	∅64
ABX-51SY	20×20×100	12/12	∅20/∅25/∅40	∅51
ABX-64SY	20×20×100	12/12	∅20/∅25/∅40	∅64
ABX-51SY	20×20×100	12/12	∅25	∅51
ABX-64SY	20×20×100	12/12	∅25	∅64
BNA-34C	20×20×100	8(16)/-	∅25	∅34
BNA-42C	20×20×100	8(16)/-	∅25	∅42
BNA-34S	20×20×100	8(16)/-	∅25	∅34
BNA-42S	20×20×100	8(16)/-	∅25	∅42
BNA-34DHY	20×20×100	8(16)/6	∅25	∅34
BNA-42DHY	20×20×100	8(16)/6	∅25	∅42
BNA-34MSY	20×20×100	8(16)/-	∅25	∅34
BNA-42MSY	20×20×100	8(16)/-	∅25	∅42
BNC-34C5	20×20×100	8/-	∅25	∅34
BNC-34S6	20×20×100	8/-	∅25	∅34
BNC-42C5	20×20×100	8/-	∅25	∅42
BNC-42S6	20×20×100	8/-	∅25	∅42
BND-51C/S2/SY2	20×20×100	12/-	∅25	∅51
BNE-34S5/SY5	20×20×100	12/12	∅25	∅34
BNE-42S6/SY6	20×20×100	12/12	∅25	∅42
BNE-51S5/SY5	20×20×100	12/12	∅25	∅51
BNE-51S6/SY6	20×20×100	12/12	∅25	∅51
BNJ-34S3/SY3	20×20×100	12/6	∅25	∅34
BNJ-42S3/SY3	20×20×100	12/6	∅25	∅42
BNJ-51SY3	20×20×100	12/6	∅25	∅51
BNX-42SY	20×20×100	12/-	∅25	∅42
BX-20S	16×16×100	8/-	∅20	∅20
BX-26S	16×16×100	10/-	∅20	∅26
BX-26T	16×16×100	8/-	∅20	∅26

STAR

product	Tool size (Gang-Type)	No	Tool size(Turret-Type)	No	Guide-bushing(D)	Max.Machining Dia.(D)
ECAS-12	10×10×95-150	6			∅22	∅13
ECAS-20	12×12×80-144	6			∅22	∅20
ECAS-20T			12×12×80	8 St.×3	∅22	∅20
ECAS-32T	16×16×80-120	4	16×16×60-78	10 St.×2	∅22/∅32	∅32
JNC-10			8×8×65	6	-	∅10
JNC-16			10×10×80	6	-	∅16
JNC-25/32			16×16×78-120	10 St.	∅22	∅25/∅32
KJR-16B/25B			16×16×78	12 St./6 St.	∅22	∅16/∅25
KNC-16/20			16×16×68	16 St.	∅22	∅16/∅20
KNC-25II/32II			16×16×78	20 St.	∅22/∅32	∅25/∅32
RNC-10/16	10×10×80-120	5			∅22	∅10/∅16
RNC-16II/16BII	10×10×80-120	5			∅22	∅16
SA-16R	10×10×95-120	6			∅22	∅16
SB-12II/16II	12×12×95-130	6			∅22	∅12/∅16
SB-16	12×12×95-130	6			∅22	∅16
SB-20	12×12×95-130	6			∅22	∅20
SR-20J	12×12×100-135	6			∅22	∅20
SC-20	12×12×95-130	6			∅22	∅20
SE-12/16	10×10×95-120	5			∅22	∅13/∅16
SF-25			16×16×73-98	10 St.×2	∅22/∅32	∅25
SG-42			16×16×84-88	10 St.×2	∅22/∅32	∅42
SH-7	8×8×95-120	5			∅22	∅7
SH-12/16	10×10×95-120	5			∅22	∅13/∅16
SI-12/12C	10×10×80-130	6			∅22	∅13
SR-16/20	12×12×95-120	5			∅22	∅16/∅20
SR-32	16×16×100-135	6			∅22	∅32
SR-20R	12×12×100-135	6			∅22	∅20
SR-10J	8×8×67-110	6			∅22	∅10
SR-25J/32J	16×16×95-155	6			∅22/∅32	∅25/∅32
SST-16	12×12×95-115	5			∅22	∅16
ST-38			16×16×85	8 St.×3	∅22/∅32	∅38
SV-12	12×12×95-135	4	12×12×70-78	8 St.×3	∅22	∅13
SV-20	16×16×95-135	5	16×16×65-70	8 St.	∅22	∅20
SV-32	16×16×95-135	4	16×16×80-88	10 St.×2	∅22/∅32	∅32
SV-32J/32JII	16×16×95-135	4	16×16×65-70	8 St.	∅22/∅32	∅32
SW-7	8×8×80-120	6				∅7
SW-20	12×12×80-144	6			∅22	∅20

TSUGAMI

product	Tool size (Gang-Type)	No	Tool size(Turret-Type)	No	Guide-bushing(D)	Max.Machining Dia.(D)
P013H/P014H	8×8×100-120	6			∅16	∅1
P033H/P04H	8×8×100-120	6			∅16	∅3
B007-III	7×7×85	8			∅25	∅7
B074/B07-V	8×8×85	9			∅20	∅7
B0123/B0124/B0125	12×12×85	9			∅20	∅12
B012F/B012-V/BE12-V	12×12×85	9			∅20	∅12
B016MF	12×12×85	9			∅20	∅16
B018-III	12×12×85	9			∅20	∅18
B0203/B0204/B0205	12×12×85	9			∅20	∅20
B020F/B020-V/BE20-V	12×12×85	9			∅20	∅20
B026-V	12×12×85	6			∅25	∅26
B0385/B0385L	16×16×125	8			∅32	∅38
BA20-III	12×12×85	6			∅25	∅20
BA26-III	12×12×85	6			∅25	∅26
BC18	12×12×85	10			∅25	∅18
BC25	12×12×85	10			∅10/∅25	∅25
BE18	12×12×85	9			∅20	∅18
BH20/BH20Z	12×12×85	4	12×12×85	12 St.	∅25/∅32	∅20
BH38	16×16×125	7	20×20×125	12 St.	∅25/∅32	∅38
BM07	8×8×85	9			∅20	∅7
BM163/BM164/BM165	12×12×85	9			∅20	∅16
BM20-V	12×12×85	9			∅20	∅20
BN12-III	12×12×85	7			∅20	∅12
BN20-III	12×12×85	7			∅20	∅20
BS12-V	12×12×85	8/12			∅20/∅25	∅12
BS18-III	12×12×85	7/10			∅14/∅25	∅18
BS20-V	12×12×85	8/12			∅20/∅25	∅20
BS26(ABC)-V	16×16×100	7/10			∅16/∅25	∅26
BS32C-V	16×16×100	6			∅16/∅25	∅32
BU12	12×12×85	4	12×12×80	8 St.	∅20	∅51
BU20	12×12×85	4	12×12×80	8 St.	∅20	∅20
BU26	16×16×100	7	20×20×80	8 St.	∅20/∅32	∅26
BU38	16×16×100	7	20×20×80	8 St.	∅20/∅32	∅38
BW07-III	12×12×85	7			∅20	∅7
BW12-III	12×12×85	7			∅20	∅12
BW20-III	12×12×85	7			∅20	∅20
C004-III	13×13×60-100	6-8			∅10	∅120
C150	10×10×60-100	4-6			∅8	∅80
C180	12×12×60-100	4-6			∅10	∅120
C220	13×13×60-100	6-8			∅10	∅120
C300-III	16×16×100-130	6-10			∅14	∅170

TSUGAMI

product	Tool size (Gang-Type)	No	Tool size(Turret-Type)	No	Guide-bushing(D)	Max.Machining Dia.(D)
CH154	12×12×60-100	16			∅10	∅15
M34J			20×20×125	12 St.	∅20/∅32	∅34
M42J/M42D/M42SD			20×20×125	12 St.	∅25/∅32	∅42
M50SY-III			20×20×100	12 St.	∅32	∅51
M50J			20×20×100	12 St.	∅20/∅32	∅51
MB25			20×20×80	8 St.×2	∅20/∅32	∅25
MB35-III			20×20×80	8 St.×2	∅20/∅32	∅35
MB38-III			20×20×80	8 St.×2	∅20/∅32	∅38
MB50-III			20×20×80	8 St.×2	∅20/∅32	∅50
MU26			20×20×80	8 St.×2	∅20/∅32	∅26
MU38			20×20×80	8 St.×2	∅20/∅32	∅38
NU50-III			20×20×100	12 St.	∅20/∅32	∅51
S205/S206	12×12×100	8			∅20/∅22	∅20
SS20	16×16×100	8			∅20/∅22	∅20
SS207	12×12×100	8			∅20/∅22	∅20
SS26	16×16×100	7			∅20/∅22	∅26
SS32/SS32L	16×16×100	7			∅20/∅22	∅32
TMB2			20×20×125	16 St.	∅32	∅51
TMU1			20×20×125	16 St.	∅32	∅38

TD15 Milling Cutter Series



Cutter Dia(D)	Straight Ramping			Circular interpolate milling		
	Max.ramp-A	Min.length-L(mm)	Max.ap (mm)	Min.Dia. (HD)	Max.Dia. (HD)	Max.pitch (rev)
32	1.4°	479	11.5	53.5		1.4
					64	2.1
40	1.0°	633	11.5	70.1		1.5
					80	1.3
50	0.8°	824	11.5	90.1		1.5
					100	1.9
63	0.6°	1073	11.5	116.1		1.5
					126	1.8
80	0.5°	1399	11.5	150.3		1.5
					160	1.8
100	0.3°	2144	11.5	190.5		1.3
					200	1.4
125	0.3°	2262	11.5	240.3		1.6
					250	1.7
160	0.2°	2933	11.5	310.3		1.6
					320	1.7
200	0.2°	3692	11.5	390.3		1.6
					400	1.7

AP17 Milling Cutter Series

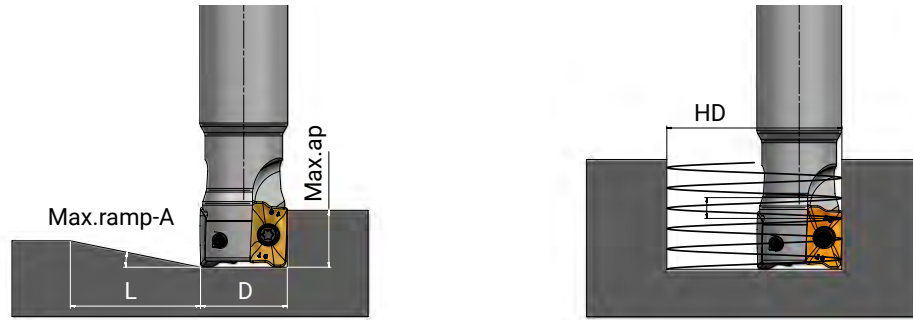

Cutter Dia(D)	Straight Ramping			Circular interpolate milling		
	Max.ramp-A	Min.length-L(mm)	Max.ap (mm)	Min.Dia. (HD)	Max.Dia. (HD)	Max.pitch (rev)
25	5.0°	184	16.1	30.6		1.3
					50	5.8
32	9.0°	102	16.1	44.6		5.3
					64	13.5
40	5.0°	184	16.1	40.6		4.8
					80	9.3
50	4.4°	209	16.1	80.6		6.3
					100	10.3
63	3.2°	288	16.1	106.6		6.5
					126	9.4
80	2.3°	401	16.1	140.6		6.5
					160	8.6
100	1.8°	513	16.1	180.6		6.8
					200	8.4

A012 Milling Cutter Series

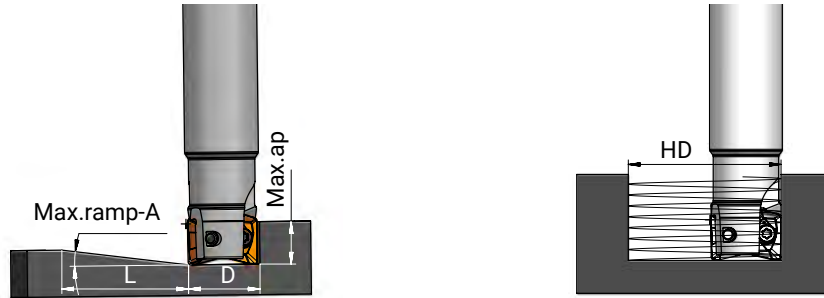

Cutter Dia(D)	Straight Ramping			Circular interpolate milling		
	Max.ramp-A	Min.length-L(mm)	Max.ap (mm)	Min.Dia. (HD)	Max.Dia. (HD)	Max.pitch (rev)
16	8.1	77.0	11	17		0.4
					32	6.1
20	5.3	119.6	11	25		1.2
					40	4.9
25	3.6	175.6	11	35		1.7
					50	4.2
32	1.7	378.0	11	49		1.3
					64	2.5
35	1.5	424.5	11	55		1.4
					70	2.4
40	1.3	468.9	11	65		1.6
					80	2.5
50	1.3	501.5	11	85		2.0
					100	2.9
63	0.9	708.6	11	111		2.0
					126	2.6
80	0.7	875.2	11	145		2.2
					160	2.7

Guideline for ATM 60 Series Thread Milling Holder



1. Positioning the milling cutter above core hole, check and adjust the length.

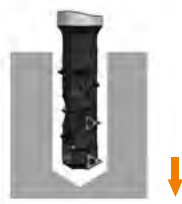

2. Get down to the request depth and check the radius.



3. Circular interpolate cutting.

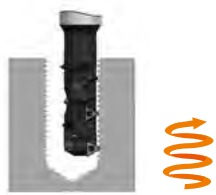

4. Milling the thread by using circular interpolation until the pitch is fully machined.



5. Circular interpolate cutting and retracting.



6. Back to start position.

LN06 Milling Cutter Series

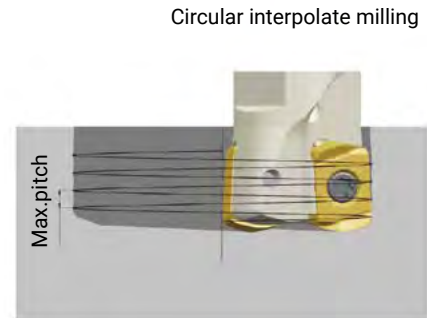
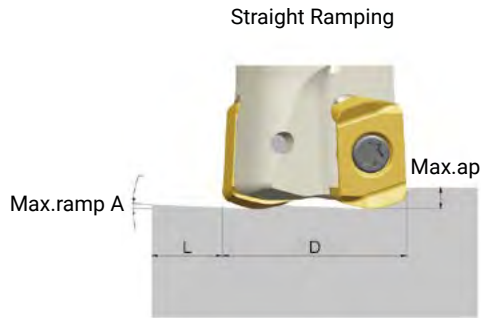

Cutter Dia(D)	Straight Ramping			Circular interpolate milling		
	Max.ramp-A	Max.ap(mm)	Min.length-L(mm)	Min.Dia.(HD)	Max.Dia.(HD)	Max.pitch (rev)
∅16	2.9°	0.65	13.8	23	32	0.65
∅17	2.6°	0.65	15.4	25	34	0.65
∅20	1.9°	0.65	21.1	31	40	0.65
∅21	1.8°	0.65	22.3	33	42	0.65
∅25	1.3°	0.65	30.8	41	50	0.65
∅26	1.3°	0.65	30.8	43	52	0.65
∅32	0.9°	0.65	44.6	55	64	0.65
∅33	0.9°	0.65	44.6	57	66	0.65
∅40	0.7°	0.65	57.3	71	80	0.65
∅50	0.5°	0.65	80.2	91	100	0.65
∅63	0.4°	0.65	100.3	117	126	0.65

NC Program Radius

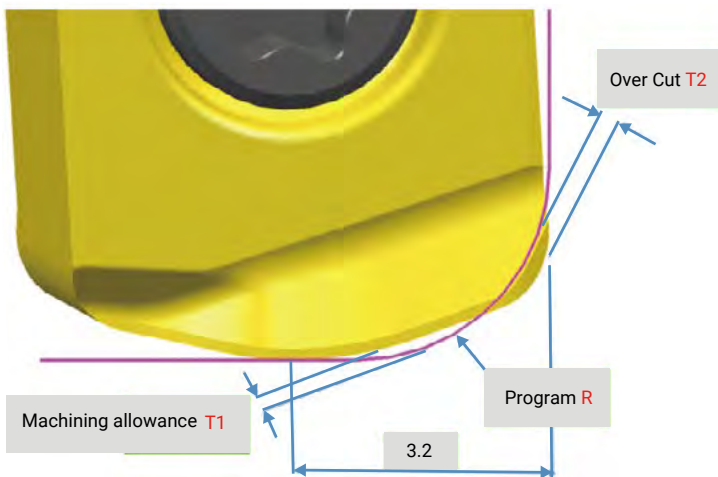

Technical information for NC program

Program R	Machining allowance T1	Over-Cut T2
R1.5	0.43	0
R2.0	0.29	0.06
R2.5	0.15	0.24

Note: Over cut won't occur when program R is set at R1.5

LN10 Milling Cutter Series

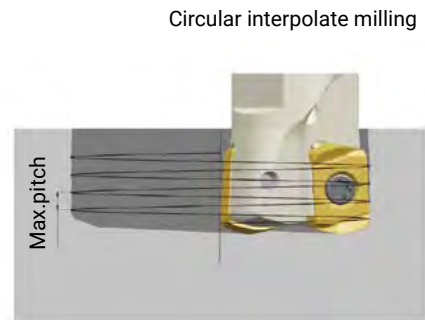
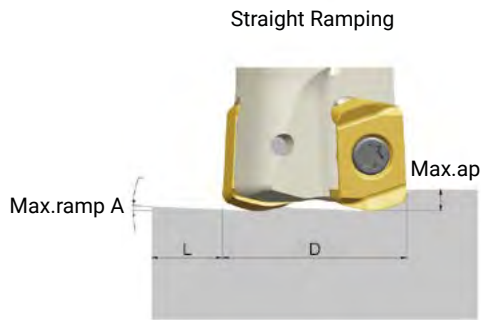

Cutter Dia(D)	Straight Ramping			Circular interpolate milling		
	Max.ramp-A	Max.ap(mm)	Min.length-L(mm)	Min.Dia.(HD)	Max.Dia.(HD)	Max.pitch (rev)
∅25	3.7°	1.2	6.9	34	50	1.2
∅26	3.4°	1.2	7.9	36	52	1.2
∅32	2.3°	1.2	15	48	64	1.2
∅33	2.2°	1.2	16	50	66	1.2
∅35	2.0°	1.2	18	54	70	1.2
∅40	1.6°	1.2	23	64	80	1.2
∅50	1.2°	1.2	33	84	100	1.2
∅63	0.9°	1.2	46	110	126	1.2
∅80	0.6°	1.2	63	144	160	1.2
∅100	0.5°	1.2	83	184	200	1.2
∅125	0.4°	1.2	108	234	250	1.2

NC Program Radius

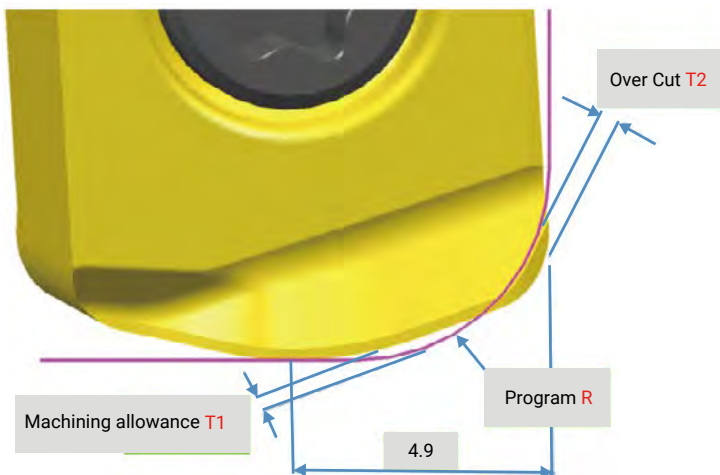













Technical information for NC program









Program R	Machining allowance T1	Over-Cut T2
R2.3	0.57	0
R2.5	0.53	0.03
R3.0	0.37	0.15

Note: Over cut won't occur when program R is set at R2.3

Solid Carbide Endmill Failure Mode and Solutions

Failure	Picture	Analysis	Solution
<p>Flank wear</p> 		<ul style="list-style-type: none"> ● Abrasion between the work piece and the flank surface leads to flank wear. 	<ul style="list-style-type: none"> ● Reduce cutting speed ● Use a more wear-resistant cutting tool material ● Increase feed ● Raise coolant flow (e.g. raise coolant pressure)
<p>Built-up edge</p> 		<ul style="list-style-type: none"> ● The work piece material stick on the cutting edge leads to built-up edge. 	<ul style="list-style-type: none"> ● Raise cutting speed ● Use more positive geometry, use a tool with a sharper cutting edge/use a sharper indexable insert ● Reduce the feed rate ● Increase the amount of grease in the coolant (e.g. 8% oil content in coolant) ● Use uncoated grade with polished geometry (e.g. for non-ferrous metals)
<p>Fractures</p> 		<ul style="list-style-type: none"> ● Perpendicular cracks along the edge lead to fractures. ● Vibration causes fractures. 	<ul style="list-style-type: none"> ● Use a tougher cutting tool material ● Reduce cutting speed ● Change to dry machining ● Adjust feed rate
<p>Plastic deformation</p> 		<ul style="list-style-type: none"> ● High heat and mechanical stress cause plastic deformation. 	<ul style="list-style-type: none"> ● Reduce cutting speed ● Reduce feed rate ● Use a more wear-resistant cutting tool material ● Use a less sharp tool ● Optimize the coolant towards to the cutting edge
<p>Thermal cracks</p> 		<ul style="list-style-type: none"> ● Fluctuating temperature (thermal shock) causes thermal cracks. 	<ul style="list-style-type: none"> ● Reduce cutting speed ● Reduce feed rate ● Dry machining or use adequate coolant ● Use a PVD-coated (tougher) indexable insert grade
<p>Notch wear</p> 		<ul style="list-style-type: none"> ● Notch wear often occurs during machining work pieces with a hard surface (forged, casted or cold work hardened). 	<ul style="list-style-type: none"> ● Change depth of cut ● Use a tougher cutting tool material ● Use a smaller approach angle ● Use a stronger geometry (with chamfer)

Solid Carbide Drill Failure Mode and Solutions

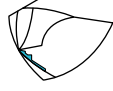
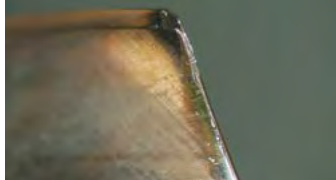
Failures	Picture	Analysis	Solution
<p>Flank wear</p> 		<ul style="list-style-type: none"> ● Abrasion between the work piece and the flank surface leads to flank wear. 	<ul style="list-style-type: none"> ● Reduce cutting speed ● Raise feed rate ● Raise coolant flow (e.g. raise coolant pressure)
<p>Built-up edge</p> 		<ul style="list-style-type: none"> ● The work piece material stick on the cutting edge leads to built-up edge. 	<ul style="list-style-type: none"> ● Raise cutting speed ● Raise coolant flow (e.g. raise coolant pressure)
<p>Fracture</p> 		<ul style="list-style-type: none"> ● Perpendicular cracks along the edges, chip eroding, vibration and extremely high wear resistance lead to fractures. 	<ul style="list-style-type: none"> ● Replace and recondition the tool sooner ● Improve stability (work piece/tool)
<p>Plastic deformation</p> 		<ul style="list-style-type: none"> ● High heat and mechanical stress cause plastic deformation. 	<ul style="list-style-type: none"> ● Reduce cutting speed ● Raise coolant flow (e.g. raise coolant pressure)
<p>Crater wear</p> 		<ul style="list-style-type: none"> ● Tool Material is too soft. ● Too high cutting speed. ● Too high feed rate. 	<ul style="list-style-type: none"> ● Choose more wear resistant grade ● Reduce cutting speed ● Reduce feed ● Raise coolant pressure

Drill Breakage Analysis

1. Check the tip geometry
2. Check the flute lengths is at least longer than drilling depth +1.5XD
3. Recondition promptly
4. Add pilot hole drilling
5. Improve system rigidity (Work piece / tool)

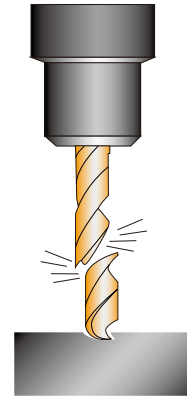

Drilling Wear and Trouble Shooting

Burr on the hole exit

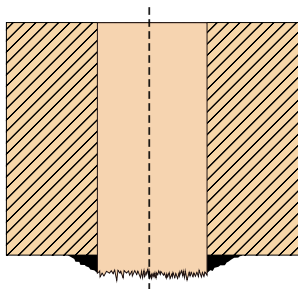

- Blunt cutting edge
- Drill tip outer corner chipped or worn

Bad surface finish

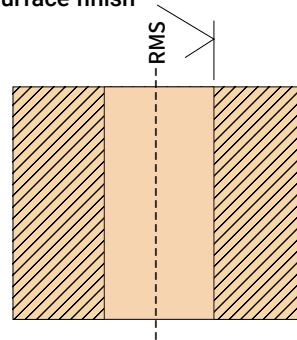

- Check edge wear
- Overcoated

Entry position out of tolerance

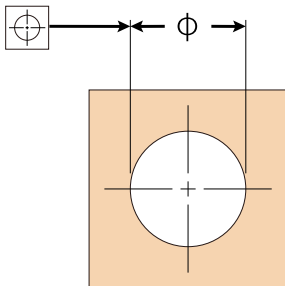

- Check edge geometry
- Check tool's cutting edge & chisel edge

Oversized holes

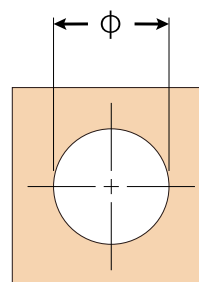

- Check edge geometry
- Overcoated
- Check tool's chisel edge

Check Coolant Supply

For solid carbide drills, internal coolant is always recommended. When the drill length is over 5xDc, internal coolant is essential. Ensure the coolant is with sufficient pressure and aiming to the correct position.

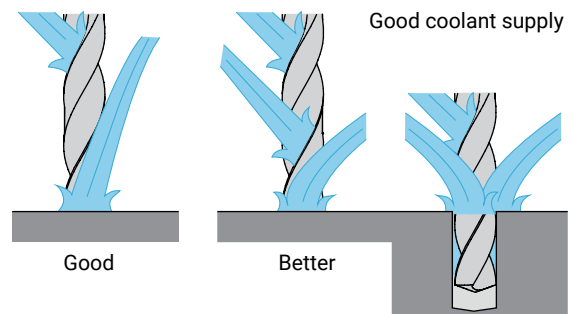
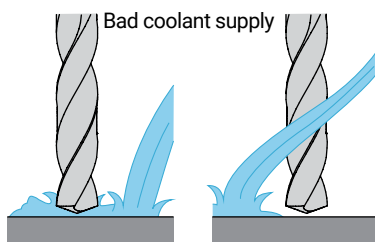

Three coolant pipes should be directly towards the drill tip when it's possible.

Installation and Adjustment Method for Cast Iron Finishing Milling Cutter

1. Clean wiper cartridge (7), completely release adjusting screw(6).
2. Clean each insert pocket, cartridge pocket, clean inserts and cartridges.
3. Install roughing inserts(1), wiper cartridges(7) and use finger to push them to the locating surface and lock the screws.
4. Install wiper inserts (5).
5. Measure the axial run out of each roughing and wiper insert.
6. Adjusting wiper inserts height through adjusting screw(6).
7. Wiper inserts Max. run out should be higher than roughing inserts by 0.03-0.06mm.

1. Roughing inserts(ON..05..)
2. Locking wedge
3. Double-headed wedge Locking screws
4. Wiper insert clamping screw
5. Wiper insert (LN12/15)

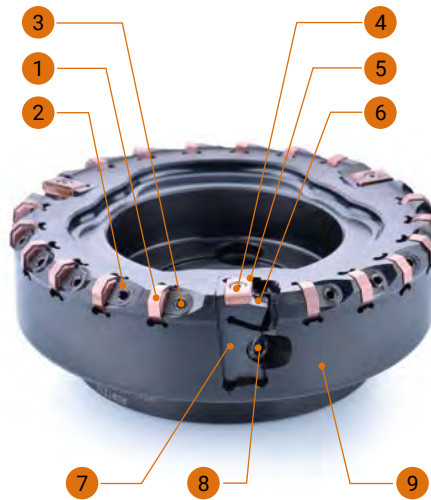

6. Adjusting screw
7. Wiper insert cartridge
8. Locking screw for wiper cartridge
9. Cutter

Grade Comparison Table for Turning

CVD coating grade

Classification	Achteck	SANDVIK	KENNAMETAL	SECO	WALTER	ISCAR	TAEGLITEC	MITSUBISHI	TUNGALOY	SUMITOMO	KYOCERA	KORLOY	ZCC.CT	PRAMET	GESAC	
P	P01	AC052P	GC4305 GC4205	KCP05B KCP05 KC9105	TP0501 TP0500	WPP05S WPP05	IC8005 IC428	TT8105	UE6005 UE6105	T9005 T9105	AC810P	CA510 CA5505	NC3010	T9310	GP1105	
	P10	AC150P	GC4415 GC4315	KCP10B KCP10 KC9110	TP1501 TP1500	WPP10S WPP10	IC9150 IC9015 IC8150	TT8115	UE6110 MC6015 MY5015	T9115 T9215	AC810P AC700G	CA515 CA5515	NC3215	YBC152 YBC151	T9315	GP1115
	P20	AC250P	GC4425 GC4325	KCP25B KC9125	TP2501 TP2500	WPP20S WPP20	IC8250 IC9025 IC9250	TT8125 TT5100	UE6020 MC6025	T9225 T9125	AC8025P AC820P AC2000	CA025P CA525 CA5525	NC3220 NC3225 NC3120	YBC251 YBC252	T9325	GP1125
	P30	AC350P	GC4335	KCP40B KCP40 KC9240	TP300 TP3500	WPP30S WPP30	IC8350 IC9350	TT8135 TT7100	MC6035 UE6035 UH6400	T9135 T9035	AC830P AC630M	CA530 CA5535	NC3030 NC500H NC5330	YBC351 YBC352	T9335	GP1135
M	M10	AC100M	GC2015 GC1515	KCM15 KCM15M			IC6015	TT9215	MC7015 US7020	T6120 T6020	AC610M AC6020M	CA6515	NC9020	YBM151 YBM153	GM1115	
	M20	AC200M	GC2025	KCM25	TM2000	WMP20S	IC6025	TT9225	MC7025	T6130	AC630M AC6020M	CA6525	NC9025	YBM251 YBM253	T7325	GM1125
	M30			KCM35 KC9045 KC9245	TM4000			TT9235	MC7035 US735					YBM253		
K	K05	AC100K AC102K	GC3205 GC3210	KCK05 KCK05B	TK0501 TK1001 TK1000	WKK10S WAK10	IC5005 IC9007	TT7005	MC5005 UC5105	T505 T5105	AC405K AC410K	CA310 CA4505	NC6205	YBD052 YBD102	T5305	GK1115
	K20	AC202K ACK15A	GC3215	KCK15 KCK20 KC9315 KC9320	TK2001 TK2000	WKK20S WAK20	IC5010	TT7310 TT7015	MC5015 UC5115	T515 T5115 T5125	AC415K AC420K AC700G	CA315 CA320 CA4515	NC6210 NC6215	YBD152C YBD152	T5315	GK1120 GK1125

Grade Comparison Table for Turning

PVD coating grade

Classification	Achteck	SANDVIK	KENNAMETAL	SECO	WALTER	ISCAR	TAEGUTEC	MITSUBISHI	TUNGALOY	SUMITOMO	KYOCERA	KORLOY	ZCC.CT	PRAMET	GESAC
P	P10	AP100S	GC1025	KC5010 KC5510 KU10T	CP200	WSM10S WSM10	IC507 IC807 IC907	MS6015 VP10MF	AH710	ACZ150 ACZ310	PR930 PR1115 PR1215	PC8110 PC230	YBG102	T6130 T8310 T8315	
	P20	AP200U AP301M	GC1020 GC1025 GC1125 GC4125	KC5025 KC5525 KC7215 KC7315 KU25T	CP250	WSM20S WSM20	IC507 IC807 IC907	TT5030 VP15TF VP20MF VP20RT UP20M	AH7025 AH725 SH725	ACZ330 AC520U	PR1225 PR1625 PR1725	PC8115 PC5300	YBG202	6630	GA4230
	P30		GC1145 GC2145	KC7235 KC7140 KC7040	CP500	WSM30S WSM30	IC328 IC928 IC3028	VP15TF VP20MF UP20M	GH330 AH740 AH9030	AC530U ACZ350	PR1535	PC3545		6640 T8330 T8030*	
M	M10	AP100S	GC1105 GC1115 GC15	KC5510 KC5010	TS2000 TH1000 CP200	WSM10 WSM10S	IC520 IC907 IC808	TT5080 VP10RT VP10MF	AH710	AC510U ACZ150	PR1215 PR1225	PC8110		T6310 T8310 T8315	GS3115
	M20	AP200U AP301M	GC1125 GC4125 GC1025 GC30	KC5025 KC5525 KCU25	CP500	WSM20 WSM20S	IC308 IC908 IC3028 IC830	TT9080 VP15TF VP20RT VP20MF	AH725 AH630 GH330 GH730 SH725 SH730	AC520U ACZ310 AC1030U	PR930 PR1215 RP1225 PR1725 PR1525	PC8115 PC5300	YBG202 YBG205	T8330	GS3125
	M30		GC2035 GC2030	KC7030 KC7225	CP600	WSM30 WSM30S	IC228 IC328 IC928	TT9020 TT8020	MP7035	AH130* AH645*	AC6040 AC530U ACZ330 ACZ350	PR1535	PC9030 PC5400		T8345
K	K05		GC1010	KC5010 KC7210	TS2000 CP200		IC807 IC910 IC507 IC908*	VP05RT	GH110 AH110	EH10Z EH510Z AC510U	PR905 PR1215			T8310	
	K20		GC1020 GC1120	KC5025 KC5525 KC7215 KC7315	TS2500 CP200 CP250		IC508 IC908	TT5030 VP10RT VP15TF VP20RT	AH120 AH725	ACZ310 AC520U AC530U AC1030U	PR905 PR1215	PC5300		T8315	GA4230
	K30		GC1030	KC7225	CP500		IC508 IC908"	VP15TF VP20RT		ACZ310				T8330	
S	S10	AP100S	GC1105 GC1115	KC5510 KC5010	CP200 TH1000 TS2000	WSM01 WSM10S	IC808 IC807 IC907	TT5080 VP05RT VP10RT MP9005	AH110 AH905 AH8005	AC510U AC5015S	PR005S PR1305 PR1310	PC8105	YBG102	T6310	GS3115
	S20	AP200U AP301M	GC1025 GC1125	KC5525 KC5025	CP500 TS2500	WSM20 WSM20S	IC808 IC908	TT9080 VP15TF VP20RT MP9015	AH120 AH8015 AH725	AC520U AC5025S	PR015S PR1325 PR1535	PC8115	YBG105 YBG202	6630	GS3125
	S30		GC1125			WSM30 WSM30S	IC328	TT9080 TT8020	MP9025	AH725	AC520U	PR1535	PC5400	YBG212	6640

Grade Comparison Table for Turning

Uncoated grade

Classification		Achteck	SANDVIK	KENNAMETAL	SECO	WALTER	ISCAR	TAEGUTEC	MITSUBISHI	TUNGALOY	SUMITOMO	KYOCERA	KORLOY	ZCC.CT	PRAMET	GESAC
N	N10	AW100K	H10	K313	H15	WK1	IC20	K10	HTI10	TH10	EH10	KW10 GW05	H01	YD101		GN9115

Cermet

Classification		Achteck	SANDVIK	KENNAMETAL	SECO	WALTER	ISCAR	TAEGUTEC	MITSUBISHI	TUNGALOY	SUMITOMO	KYOCERA	KORLOY	ZCC.CT	PRAMET	GESAC
P	P10	AT202	CT5015 CT525 GC1525*	KT175 HT2 KTP10*	TP1020 CM CMP	WTA43* WTA41*	IC20N IC520N	CT3000 PV3010*	NX2525 AP25N* VP25N*	NS9530 NS520 GT9530* GT530*	T1200A T1500Z*	TN60 TN620 TN6020 PV720*	CN2000 CN20 CC1500* CN1500*	NG151 YNG151C*		GP91TM GT31TM*
K	K10	AT202	CT5015	HTX KT315* KTP10*				CT3000	NX2525 AP25N* VP25N*	NS530 GT530*	T1200A T2000Z*	TN610 PV710* PV7005*	CN1500*	YNG151 YNG151C*		GP91TM GT31TM*

Grade Comparison Table for Turning

CBN

Classification		Achteck	SANDVIK	KENNAMETAL	SECO	WALTER	ISCAR	TAEGUTEC	MITSUBISHI	TUNGALOY	SUMITOMO	KYOCERA	KORLOY	ZCC.CT	PRAMET	GESAC
K	K10	PB90			CBN20 CBN600				MB4120 MBS140	BX950 BX90S	BN7000 BNS800		DBN350			
H	H10	PB30	CB7105 CB7050"	KBH10 KB1615 KB5610	CBN150 CBN060K CBN200	WCB30	IB50	TB610	MB8025 MB825	BXA40 BC330 BX360						
H	H20	PB60	CB7025 CB7525	KBH20 KB1340	CBN350 CBN500	WCB50	IB55	TB650	MB8025	BX380						
	H30		CB7525	KB5630			IB55	TB670	MB835	BX380						

PCD

Classification		Achteck	SANDVIK	KENNAMETAL	SECO	WALTER	ISCAR	TAEGUTEC	MITSUBISHI	TUNGALOY	SUMITOMO	KYOCERA	KORLOY	ZCC.CT	PRAMET	GESAC
N	N20	PD20		KD1425	PCD30 PCD30M	WDN10			MD230	DX110 DX120	DA1000 DA2200	KPD001 KPD010 KPD230 KPD250				DNN130P

Grade Comparison for Milling Grade

Classification	Achteck	SANDVIK	KENNAMETAL	SECO	WALTER	ISCAR	TAEGUTEC	MITSUBISHI	TUNGALOY	SUMITOMO	KYOCERA	KORLOY	ZCC-CT		
P	P10		GC1025 GC1010	KC715M				F7010		ACP100	PR1225	PC33525	YBG252		
	P20	AP251U	GC1130 GC1030 GC4220 GC4020 GC4030	KC522M KC525M KCPM20	MP1500 T250M T25M T20M		WKP25S	IC330 IC250 IC950 IC520M	TT7080 TT7030	MC7020 MP6120 MV1020 UP20M F7030	T313W AH725	ACP200 ACP2000 ACP2500	PR1525 PR1225 PR1230	PC3535 PC3500	YBC301 YBC302 YBM251 YBG202 YBG252
	P30	AP351U AP351M AC301P	GC1130 GC4040 GC4230 GC4330	KC994M KC725M KC792M KC530M	MP2500 T250M T25M F30M	WSM35S WSM36 WKP35S WKP35G	IC330 IC328 IC830 IC908	TT9080 TT9030 TT7080	MP6130 VP15TF VP30RT F7030	T3130 GH330 AH120 AH330 AH730	AC230 ACP300	PR1230 PR1535	PC5300 PC9530 PC3600	YBM351 YBM251 YBM301 YBG302	
	P40	AP403M	GC4040 GC4240 GC4340	KC735M	MP300 T350M T60M T25M		WKP45S WSP46	IC635 IC928 IC4050	TT9030	VP30RT	AH140		AC230 ACZ330 ACZ350		PC9530
M	M10		GC1025 GC1030	KC522M				TT9300	F7010	T6120 T6020	ACM100 ACM200	PR1225	NC5330	YBG252	
	M20	AP251U	GC2030 GC2334 GC2044 S30T	KC730M KC525M	MS2050 MP2500 T250M T25M F20M		WXM15	IC380 IC908 IC928	TT9300	MC7020 VP15TF VP20RT MP7030 MP7130	T6130	ACM200 ACP200 ACU2500	PR1525 PR1225	PC5300 PC3545 PC9530	YBM251 YBM253 YBC302 YBG205 YBG252
	M30	AP351U AP351M	GC1040 GC2040 S40T	KC994M KC725M KCPK30	T350M T250M F40M	WSM35S WSM36	IC380 IC328 IC330	TT9080 TT8020	F7030 VP30RT M07140			ACM300 ACP300 ACZ350	CA6535 PR1535	PC3545 PC5300	YBC302 YBG351 YBG302
	M40	AP403M			MM4500	WKP45S WSP46	IC830	TT8080 TT8020 TT9300	VP30RT			ACZ350		PC9530	YBG302
K	K01				MH1000		IC5100 IC4100			T505 T5105	ACK100				
	K10		GC1010 GC3220 K15W	KCK15 KC915M	MK1500 T150M F15M	WXM15 WAK15 WSN10	IC5100 IC4010 IC910 IC810	K10	MP8010 MC5020 MV1020 VP10RT	T515 T5115 T5125	ACK2000 ACK200 AC211	PR1500 PR1210 PR905	PC215K	YBD152 YBG102 YBG252	
	K20	AP251K AP351K AC301K	GC1020 GC3020 GC3330 GC3334	KCC520M KC920M KC925M	MP1500 T250M MK2000 MK2050	WKP25S WKK25S	IC810 IC910 IC928	TT6080 TT7515	VP15TF VP20RT	AH120 AH725 T1215	EH20Z ACZ310 ACK300 ACK3000	CA420M PR1210 CA415D PR905	PC6510 PC5300	YBD152 YBD252 YBG152	
	K30		GC3040 GC4040	KC930M	MK3000 T250M	WKP35S	IC928	TT7515		GH130				YBD252 YBG152	
S	S10		GC1030 GC1025 GC1010	KC510M	MS2050		IC903 IC807 IC808 IC908	K10	MP9120 VP15TF		ACM100 ACM200	CA6535 PR1535 PR1210		YBG202 YBS203	
	S20		GC1030 GC2030 GC1130	KC525M	MP2050	WSM35S WSM36	IC903 IC807 IC808 IC908 IC830	TT9080 TT9030 TT5525	MP9120 VP15TF MP9130 MP9030		ACU2500 ACM200	CA6535 PR1535 PR1210		YBS203 YBS303	
	S30	AP403S	GC2040 S40T	KC725M KCSMN40	F40M	WSP45S WSP46 WSM42X WMP45G	IC328 IC330	TT8080 TT8020 TT9300	MP9140		ACM300	PR1535		YBS303	

Chip Breaker Comparison Table for Negative Turning Insert

ISO Classification	Application	ACHTECK	SANDVIK	KENNAMETAL	SECO	WALTER	ISCAR	TAEGUTEK	MITSUBISHI	TUNGALOY	SUMITOMO	KYOCERA	KORLOY	ZCC.CT
P	Finishing	PB1	QF	FF	FF1 MF2 FF2	NF3 FP5	SF F3P	FS FA FLP FG FC	FP FH FY FS	TF	FA FB FL SU	GP PP XP XF	VG VL VF	SF DF
	Semi finishing	PB3 PC3	PF LC	FN	MF5	NS6	NF	MLP	C SA SH	TSF	LU SX NSE	CQ XQ HQ	VC HC	NM
	Medium	PL5	K		UX			V FS	ES 2G	S	GX HM	LD ST	SH	
		PD3	PM PMC QM	MN CT	M3	NM4 MP5	M3P TF PP	MT MC MP MGP	MA MP MV MH	TM ZM AM NM	GU UX UG UP	GS PS PG	VM LP MP	PM DM
		PC4			M4			MG-	Standard	Standard	UZ	Standard	B25	
	Roughing	PD5	PR	RN RP RW	M5 M6 MR7	NM6 NM9 RP5 RP7	NR R3P	RT RGP	RP GH	TH	MU, MX	PT GT	HR GR	DR ER
	Heavy roughing	PD8 PC8	PR QR	RM	R4 R5	NR6 NRF	MH	RX RH	HZ HL	TRS	HG MP		GH	DR
		PC9	HR	RP	R7 R8	NR8		HT HD	HX HR	TU TUS	HF		VT	HDR
		PD9		RH	RR9	NRR	HR	HY HZ	HV		HU HW		VH	HPR
M	Finishing	SC1 MB2	MF	FF LF FP	MF2	NF NF4 FM5	NF F3M	FG EA SF	LS FS SA	SS TF SF HRF	SU EF	MQ	VP1	EF
	Semi finishing	SL3		MS	MF1	MS3	PP	ML	MJ	28	UP	TK	HA	
		MC3	MM MMC	MP UP	MF4 MF3	NM NM4	M3M	EM MP	MS GM MM MA	HRM SM SA	EX GU	MS MU SU	HS	EM
	Roughing	MC4	MR MMR	RP	M5 MR7	NR4 RM5	R3M MR	ET	RM GH	TU SH	MU	HU	VM	ER
K	Medium	PC4	KM	UN CT	M4	MK5 NM5 NM6	NR	Standard	MK GK Standard	CM Standard	UZ MU	KG Standard	B25	Standard
	Roughing	KC4 KD5	KR	RP- NMA	MR7 Plane	RK5 RK7 Plane	Plane	KT RT Plane	GH RK Plane	CH Plane	GZ	ZS GC KH PH Plane	GR VR VK- Plane	DR
N	Semi finishing		QM 23	MS MP			PP	ML	MJ	P	UP GX AG	A3 AH	HA	
S	Finishing	SC1 MB2	MF SF	FS	MF2	NF4	NF	EA SF"	FS LS	TF	SU	MQ SQ	VP1	EF
	Medium	SL3		MS	MF1	MS3	PP	ML	MJ	28	UP	TK	HA	
		SC3	SM SMC	UP	MR3	NMS NMT	TF	MP SU MK	MS	HMM SA HRM	EG EX	MS MU	VP3	NM
		Roughing	MC4	SR SMR	RP	MR4	NRS NRT	NR		GJ RS		MU	SG	VM

Chip Breaker Comparison Table for Positive Turning Insert

ISO Classification	Application	Achteck	SANDVIK	KENNAMETAL	SECO	WALTER	ISCAR	TAEGUTEK	MITSUBISHI	TUNGALOY	SUMITOMO	KYOCERA	KORLOY	ZCC.CT
P	Finishing	LF										CK		
		UF PB1 BS	UF PF	11 UF	FF1 MF2	PF4 FP4	PF	FA FG FX	FV FP	PF	FP LU	GP VF	VL	HF
	Semi finishing	PC2	PM UM	LF MF	F2 M5	FP6 PS5 MP4	SM 14	PC	MP MV	PM 23 24	SU SC	HQ XQ GK	HMP	HM
	Roughing	KC2	PR			PM5 RP4	17 19	MT	no code		MU		C25	
M	Finishing	PB1	MF UF	11 UF	FF1 MF2	PF4 FM4	PF	FA FG	FM FV LM	PF	LU	MQ	VL	EF
	Semi finishing	PC2	MM UM	LF MF	F2 M5	PS5 MM4	SM 14	FM	MV MM	PS PM	SC SU	MS	MP	EM
	Roughing	KC2	MR UR			PM5 RM4	17	MT			MU	MU	C25	HR
K	Semi finishing	KC2	KM	MF	F2 M3	MK4	14	MT PMR	MK	CM	MU		C25	HM
	Roughing	KD5	KR		M5	RK4 RK6 Plane		CMX		Plane				HR
N	Semi finishing	NC2	AL	HP	AL	PM2	AF, AS	FL	AZ	AL	AW, AG	AH	AK, AR	LH
S	Finishing	UF PB1	MF	HP	F1	PF5 PF4	PF	FA	FJ		LU	MQ	VP1 VL	NF NGF
	Medium	PC2	MM UM	LF	F2	PS5 PM5	SM	FG	MS	PS	SU	HQ	MP	
	Roughing													SNR

Turning Machining Formula

● Cutting speed

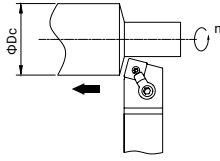

$$V_c = \frac{\pi * D_c * n}{1000} \text{ (m/min)}$$

Vc:Cutting speed(m/min) π: ≈3.14
Dc:Workpiece diameter(mm) n:Spindle speed(rev/min)

● Feed speed

$$V_f = f * n \text{ (mm/min)}$$

Vf:Cutting speed(mm/min) f:Feed rate(mm/rev)
n:Spindle speed(rev/min)

● Chip thickness

$$h = f * \text{sinkr} \text{ (mm)}$$

h:Chip thickness(mm) f:Feed rate(mm/rev)

● Chip width

$$b = \frac{a_p}{\text{sinkr}} \text{ (mm)}$$

b:Chip width(mm) ap:Axial depth of cut (mm)

● Chip area

$$A = h * b = a_p * f \text{ (mm}^2\text{)}$$

A:Chip area(mm²) ap:Axial depth of cut (mm)
f:Feed rate(mm/rev)

● Cutting force

$$F_c = K_c * a_p * f \text{ (N)}$$

Fc:Cutting force(N) Kc:Unit cutting force(N/mm²)
ap:Axial depth of cut (mm) f:Feed rate(mm/rev)

● Cutting power

$$P_{mot} = \frac{K_c * V_c * a_p * f}{60000 * \eta} \text{ (KW)}$$

Pmot:Cutting power(KW) Kc:Unit cutting force(N/mm²)
Vc:Cutting speed(m/min) ap:Axial depth of cut (mm)
f:Feed rate(mm/rev) η:Mechanical efficiency

● Chip removal

$$Q = a_p * f * V_c \text{ (cm}^3\text{/min)}$$

Q:Chip removal(cm³/min) ap:Axial depth of cut (mm)
f:Feed rate(mm/rev) Vc:Cutting speed(m/min)

● Theoretic surface roughness

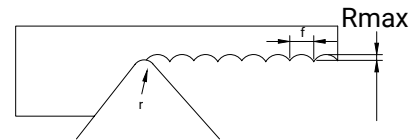

$$R_{max} = \frac{f^2}{8 * r} * 1000 \text{ (um)}$$

Rmax:Theoretic surface roughness (um)
f:Feed rate(mm/rev) r:Corner radius (mm)

● Work time

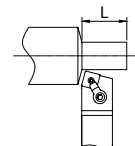

$$T_c = \frac{L}{f * n} \text{ (min)}$$

Tc:Work time f:Feed rate(mm/rev)
n:Spindle speed(rev/min) L: Working length(mm)

Milling General Formula

● **Cutting speed**

$$V_c = \frac{\pi * D_c * n}{1000} \text{ (m/min)}$$

V_c:Cutting speed(m/min) π: ≈3.14
D_c:Cutter diameter(mm) n:Spindle speed(rev/min)

● **Spindle speed**

$$n = \frac{1000 * V_c}{\pi * D_c} \text{ (rev/min)}$$

V_c:Cutting speed(m/min) π: ≈3.14
D_c:Cutter diameter(mm) n:Spindle speed(rev/min)

● **Feed speed**

$$V_f = f_z * n * Z \text{ (mm/min)}$$

V_f:Feed speed(mm/min) f_z:Feed per tooth(mm/z)
n:Spindle speed(rev/min) Z:Number of teeth

● **Feed rate per rev.**

$$f_z = \frac{V_f}{n * Z} \text{ (mm/z)}$$

f_z:Feed rate per rev.(mm/z) V_f:Feed speed(mm/min)
n:Spindle speed(rev/min) Z:Number of teeth

● **Feed rate per rev.**

$$f = \frac{V_f}{n} \text{ (mm/rev)}$$

f:Feed rate per rev.(mm/rev) V_f:Feed speed(mm/min)
n:Spindle speed(rev/min)

● **Time of cut**

$$T_c = \frac{L}{V_f} \text{ (min)}$$

T_c:Time of cut(min) L:Length of feed(mm)
V_f:Feed speed(mm/min)

● **Horse power**

$$H_p = \frac{P_{mot}}{0.75}$$

H_p:Horse power P_{mot}:Cutting power(KW)

● **Power demand**

$$P_{mot} = \frac{a_p * a_e * V_f * K_c}{6 * 10^7 * \eta} \text{ (KW)}$$

P_{mot}:Cutting power(KW) a_p:Cutting depth a_e:Cutting width
K_c:Unit cutting force(N/mm²) η:Machine efficiency coefficient(0.7-0.95)

● **Average chip thickness**

$$h_m = \frac{114.7 * f_z * \sin \psi * (a_e/D_c)}{\psi_s} \text{ (mm)}$$

h_m:Average chip thickness f_z:Feed per tooth(mm/z)
a_e:Cutting width D_c:Cutter diameter(mm) ψ_s:Pressure angle

● **Feed force**

Cutter in the center site

$$\psi_s = 2 * \arcsin \left(\frac{a_e}{D_c} \right) [^\circ]$$

Cutter in excentric site

$$\psi_s = 90^\circ + \arcsin \frac{a_e - (D_c/2)}{(D_c/2)} [^\circ]$$

ψ_s:Pressure angle a_e:Cutting width
D_c:Cutter diameter(mm)

● **Chip removal**

$$Q = \frac{a_p * a_e * V_f}{1000} \text{ (cm}^3\text{/min)}$$

Q:Chip removal(cm³/min) a_p:Cutting depth
a_e:Cutting width V_f:Feed speed(mm/min)

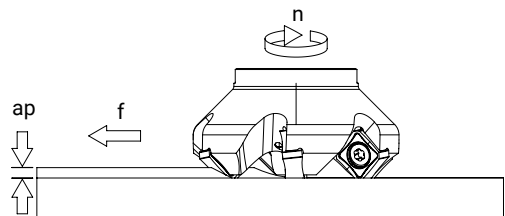
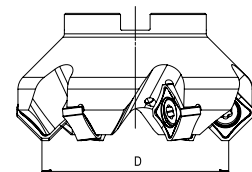

Drilling General Recommendation

● **Cutting speed**

$$V_c = \frac{\pi * D_c * n}{1000} \text{ (m/min)}$$

Vc:Cutting speed(m/min) $\pi \approx 3.14$
Dc:Drill diameter(mm) n:Spindle speed(rev/min)

● **Spindle speed**

$$n = \frac{1000 * V_c}{\pi * D_c} \text{ (rev/min)}$$

Vc:Cutting speed(m/min) $\pi \approx 3.14$
Dc:Drill diameter(mm) n:Spindle speed(rev/min)

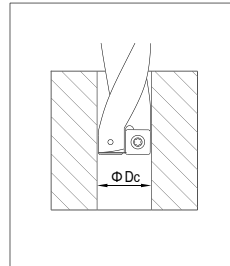

● **Feed speed**

$$V_f = f_z * n * Z \text{ (mm/min)}$$

Vf:Feed speed(mm/min) fz:Feed per tooth(mm/z)
n:Spindle speed(rev/min) Z:Number of teeth

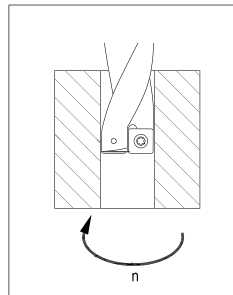

● **Feed rate per rev.**

$$f_z = \frac{V_f}{n * Z} \text{ (mm/z)}$$

fz:Feed per tooth(mm/z) Vf:Feed speed(mm/min)
n:Spindle speed(rev/min) Z:Number of teeth

● **Feed rate per rev.**

$$f = \frac{V_f}{n} \text{ (mm/rev)}$$

f:Feed rate per rev.(mm/rev) Vf:Feed speed(mm/min)
n:Spindle speed(rev/min)

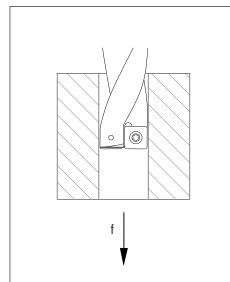

● **Chip removal**

$$Q = \frac{V_f * \pi * D_c^2}{4 * 1000} \text{ (cm}^3\text{/min)}$$

Q:Chip removal(cm³/min) Vf:Feed speed(mm/min)
 $\pi \approx 3.14$ Dc:Drill diameter(mm)

● **Horse power**

$$H_p = \frac{P_{mot}}{0.75}$$

Hp:Horsepower Pmot:Cutting power(KW)

● **Power demand**

$$P_{mot} = \frac{Q * K_c}{60000 * \eta} \text{ (KW)}$$

Pmot:Cutting power(KW) Q:Chip removal(cm³/min)
Kc:Unit cutting force(N/mm²)
 η :Machine efficiency coefficient (0.7-0.95)

● **Torque**

$$M_c = \frac{D_c^2 * K_c * f}{8000} \text{ (N*m)}$$

Mc:Torque Dc:Drill diameter(mm)
Kc:Unit cutting force(N/mm²) f:Feed rate per rev.(mm/rev)

● **Feed force**

$$F_f = 0.63 * \frac{f * D_c * K_c}{2} \text{ (N)}$$

Ff:Feed force f:Feed rate per rev.(mm/rev)
Dc:Drill diameter(mm) Kc:Unit cutting force(N/mm²)

● **Cutting thickness**

$$h = f_z * \text{sink} \text{ (mm)}$$

h:Cutting thickness(mm) fz:Feed rate(mm/rev)

Hardness Conversion Table

Brinell Hardness 10 ball load 3000Kg		Micro Vickers Hardness HV	Rockwell Hardness				Shore's Hardness	Tensile Strength (approximate) kgf/mm
Master ball	WC ball HB		A scale 60kgf diamond brale HRA	B scale 100kgf 1/16in ball HRB	C scale 150kgf diamond brale HRC	D scale 100kgf diamond brale HRD		
-	-	1865	92.0	-	80	-	-	
-	-	1787	91.5	-	79	-	-	
-	-	1710	91.0	-	78	-	-	
-	-	1633	90.5	-	77	-	-	
-	-	1556	90.0	-	76	-	-	
-	-	1478	89.5	-	75	-	-	
-	-	1400	89.0	-	74	-	-	
-	-	1323	88.5	-	73	-	-	
-	-	1245	88.0	-	72	-	-	
-	-	1160	87.0	-	71	-	-	
-	-	1076	86.5	-	70	-	-	
-	-	1004	86.0	-	69	-	-	
-	-	940	85.6	-	68.0	76.9	97	
-	-	920	85.3	-	67.5	76.5	96	
-	-	900	85.0	-	67.0	76.1	95	
-	767	880	84.7	-	66.4	75.7	93	
-	757	860	84.4	-	65.9	75.3	92	
-	745	840	84.1	-	65.3	74.8	91	
-	733	820	83.8	-	64.7	74.3	90	
-	722	800	93.4	-	64.0	73.8	88	
-	712	-	-	-	-	-	-	
-	710	780	83.0	-	63.3	73.3	87	
-	698	760	82.6	-	62.5	72.6	86	
-	684	740	82.2	-	61.8	72.1	-	
-	682	737	82.2	-	61.7	72.0	84	
-	670	720	81.8	-	61.0	71.5	83	
-	656	700	81.3	-	60.1	70.8	-	
-	653	697	81.2	-	60.0	70.7	81	
-	647	690	81.1	-	59.7	70.5	-	
-	638	680	80.8	-	59.2	70.1	80	
-	630	670	80.6	-	58.8	69.8	-	
-	627	667	80.5	-	58.7	69.7	79	
-	601	640	79.8	-	57.3	68.7	77	
-	578	615	79.1	-	56.0	67.7	75	
-	555	591	78.4	-	54.7	66.7	73	
-	534	569	77.8	-	53.5	65.8	71	
-	514	547	76.9	-	52.1	64.7	70	
-	495	528	76.3	-	51.0	63.8	68	
-	477	508	75.6	-	49.6	62.7	66	
-	461	491	74.9	-	48.5	61.7	65	
-	444	472	74.2	-	47.1	60.8	63	
429	429	455	73.4	-	45.7	59.7	61	
415	415	440	72.8	-	44.5	58.8	59	
401	401	425	72.0	-	43.1	57.8	58	
388	388	410	71.4	-	41.8	56.8	56	
375	375	396	70.6	-	40.4	55.7	54	
363	363	383	70.0	-	39.1	54.6	52	
352	352	372	69.3	(110.0)	37.9	53.8	51	
341	341	360	68.7	(109.0)	36.6	52.8	50	
331	331	350	68.1	(108.5)	36.6	51.9	48	
321	321	339	67.5	(108.0)	34.3	51.0	47	
311	311	328	66.9	(107.5)	33.1	50.0	46	
302	302	319	66.3	(107.0)	32.1	49.3	45	
293	293	309	65.7	(106.0)	30.9	48.3	43	
285	285	301	65.3	(105.5)	29.9	47.6	-	
277	277	292	64.6	(104.5)	28.8	46.7	41	

Hardness Conversion Table

Brinell Hardness 10 ball load 3000Kg		Micro Vickers Hardness HV	Rockwell Hardness				Shore's Hardness	Tensile Strength (approximate) kgf/mm
Master ball	WC ball HB		A scale 60kgf diamond brale HRA	B scale 100kgf 1/16in ball HRB	C scale 150kgf diamond brale HRC	D scale 100kgf diamond brale HRD		
269	269	284	64.1	(104.0)	28	45.9	40	91
262	262	276	63.6	(103.0)	27	45.0	39	89
255	255	269	63.0	(102.0)	25	44.2	38	86
248	248	261	62.5	(101.0)	24	43.2	37	84
241	241	253	61.8	100	23	42.0	36	82
235	235	247	61.4	99	22	41.4	35	80
229	229	241	60.8	98.2	21	40.5	34	78
223	223	234	-	97.3	(18.8)	-	-	-
217	217	228	-	96.4	(17.5)	-	33	74
212	212	222	-	95.5	(16.0)	-	-	72
207	207	218	-	94.6	(15.2)	-	32	70
201	201	212	-	93.8	(13.8)	-	31	69
197	197	207	-	92.8	(12.7)	-	30	67
192	192	202	-	91.9	(11.5)	-	29	65
187	187	196	-	90.7	(10.0)	-	-	63
183	183	192	-	90	(9.0)	-	28	63
179	179	188	-	89	(8.0)	-	27	61
174	174	182	-	87.8	(6.4)	-	-	60
170	170	178	-	86.8	(5.4)	-	26	58
167	167	175	-	86	(4.4)	-	-	57
163	163	171	-	85	(3.3)	-	25	56
156	156	163	-	82.9	(0.9)	-	-	53
149	149	156	-	80.8	-	-	23	51
143	143	150	-	78.7	-	-	22	50
137	137	143	-	76.4	-	-	21	47
131	131	137	-	74	-	-	-	46
126	126	132	-	72	-	-	20	44
121	121	127	-	69.8	-	-	19	42
116	116	122	-	67.6	-	-	18	41
111	111	117	-	65.7	-	-	17	39

Material Conversion Table

ISO	Country and standard										
	China	International	Germany	U.S.A.	U.K.		France	Sweden	Italy	Spain	Japan
	GB	DIN	W.-nr	AISI/SAE	BS	EN	AFNOR	SS	UNI	UNE	JIS
P	Structural steel										
	15	C15	1.0401	1015	080M15	-	CC12	1350	C15C16	F.111	-
	20	C22	1.0402	1020	050A20	2C	CC20	1450	C20C21	F.112	-
	35	C35	1.0501	1035	060A35	-	CC35	1550	C35	F.113	-
	45	C45	1.0503	1045	080M40	-	CC45	1650	C45	F.114	-
	55	C55	1.0535	1055	070M55	-	-	1655	C55	-	-
	60	C60	1.0601	1060	080A62	43D	CC55	-	C60	-	-
	Y15	9SMn28	1.0715	1213	230M07	-	S250	1912	CF9SMn28	11SMn28	SUM22
	-	9SMnPb28	1.0718	12L13	-	-	S250Pb	1914	CF9MnPb28	11SMnPb28	SUM22L
	-	10SPb20	1.0722	-	-	-	10PbF2	-	CF10Pb20	10SPb20	-
	-	35S20	1.0726	1140	212M36	8M	35MF4	1957	-	F210G	-
	Y13	9SMn36	1.0736	1215	240M07	1B	S300	-	CF9SMn36	12SMn35	-
	-	9SMnPb36	1.0737	12L14	-	-	S300Pb	1926	CF9SMnPb36	12SMnP35	-
	55Si2Mn	55Si9	1.0904	9255	250A53	45	55S7	2085	55Si8	56Si7	-
	-	60SiCr7	1.0961	9262	-	-	60SC7	-	60SiCr8	60SiCr8	-
	15	Ck15	1.1141	1015	080M15	32C	XC12	1370	C16	C15K	S15C
	40Mn	40Mn4	1.1157	1039	150M36	15	35M5	-	-	-	-
	25	Ck25	1.1158	1025	-	-	-	-	-	-	S25C
	35Mn2	36Mn5	1.1167	1335	-	-	40Mn5	2120	-	36Mn5	SMn438(H)
	30Mn	28Mn6	1.117	1330	150M28	14A	20M5	-	C28Mn	-	SCMn1
	35Mn	Cf35	1.1183	1035	060A35	-	XS38TS	1572	C36	-	S35C
	Ck45	45	1.1191	1045	080M46	-	XC42	1672	C45	C45K	S45C
	55	Ck55	1.1203	1055	070M55	-	XC45	-	C50	C55K	S55C
	50	Cf53	1.1213	1050	060A52	-	XC48TS	1674	C53	-	S50C
	60Mn	Ck60	1.1221	1060	080A62	43D	XC60	1678	C60	-	S58C
	-	Ck101	1.1274	1095	060A96	-	-	1870	-	-	SUP4
	-	X120Mn12	1.3401	-	Z120M12	-	X120M12	-	XG120Mn12	X120Mn12	SCMnH/1
	GCr15	100Cr6	1.3505	52100	534A99	31	100C6	2258	100Cr6	F.131	SUJ2
	-	15Mo3	1.5415	ASTM A204Gr.A	1501-240	-	15D3	2912	16Mo3KW	16Mo3	-
	-	16Mo5	1.5426	4520	1503-245-420	-	-	-	16Mo5	16Mo5	-
-	14Ni6	1.5622	ASTM A350LF5	-	-	16N6	-	14Ni6	15Ni6	-	
-	X8Ni9	1.5662	ASTM A353	1501-509; 510	-	-	-	X10Ni9	XBNi09	-	

Material Conversion Table

ISO	Country and standard										
	China	International	Germany	U.S.A.	U.K.		France	Sweden	Italy	Spain	Japan
	GB	DIN	W.-nr	AISI/SAE	BS	EN	AFNOR	SS	UNI	UNE	JIS
P	Structural steel										
	-	12Ni19	1.5680	2515	-	-	Z18N5	-	-	-	-
	-	36NiCr6	1.5710	3135	640A35	111A	35NC6	-	-	-	SNC236
	-	14NiCr10	1.5732	3415	-	-	14NC11	-	16NiCr11	15NiCr11	SNC415 (H)
	-	14NiCr14	1.5752	34153310	655M13655A12	36A	12NC15	-	-	-	SNC815 (H)
	-	36CrNiMo4	1.6511	9840	816M40	110	40NCD3	-	38CrNiMo4 (KB)	35CrNiMo4	-
	-	21NiCrMo2	1.6523	8620	850M20	362	20NCD2	2503	20NiCrMo2	20NiCrMo2	SNCCM220 (H)
	-	40NiCrMo2	1.6546	8740	311-Type7	-	-	-	40NiCrMo2 (KB)	40NiCrMo2	SNC240
	40CrNiMoA	34CrNiMo6	1.6582	4340	817M40	24	35NCD6	2541	35CrNiMo6 (KB)	-	-
	-	17CrNiMo6	1.6587	-	820A16	-	18NCD6	-	-	14CrNiMo1	-
	15Cr	15Cr3	1.7015	5015	523M15	-	12C3	-	-	-	SCr415(H)
	35Cr	34Cr4	1.7033	5132	530A32	18B	32C4	-	34Cr4(KB)	35Cr4	SCr430(H)
	40Cr	41Cr4	1.7035	5140	530M40	18	42C4	-	41Cr4	42Cr4	SCr440(H)
	40Cr	42Cr4	1.7045	5140	-	-	-	2245	-	42Cr4	SCr440
	18CrMn	16MnCr15	1.7131	5115	(527M20)	-	16MC5	2511	16MnCr15	16MnCr15	-
	20CrMn	55Cr3	1.7176	5155	527A60	48	55C3	-	-	-	SUP9(A)
	30CrMo	25CrMo4	1.7218	4130	1717CDS110	-	25CD4	2225	25CrMo4 (KB)	55Cr3	SCM420; SCM430
	35CrMo	34CrMo4	1.7220	4137;4135	708A37	19B	35CD4	2234	35CrMo4	34CrMo4	SCM432; SCRMM3
	40CrMoA	41CrMo4	1.7223	4140;4142	708M40	19A	42CD4TS	2244	41CrMo4	41CrMo4	SCM440
	42CrMo 42CrMnMo	42CrMo4	1.7225	4140	708M40	19A	42CD4	2244	42CrMo4	42CrMo4	SCM440(H)
	-	15CrMo5	1.7262	-	-	-	12CD4	2216	-	12CrMo4	SCM415(H)
	-	13CrMo44	1.7335	ASTMA182F11; F12	1501-620Gr.27	-	15CD3.5; 15CD4.5	-	14CrMo44	14CrMo45	-
	-	32CrMo12	1.7361	-	722M24	40B	30CD12	2240	32CrMo12	F.124.A	-
	-	10CrMo910	1.7380	ASTMA182F.22	1501-622Gr.31;45	-	12CD9;10	2218	12CrMo9,10	TU.H	-
	-	14MoV63	1.7715	-	1503-660-440	-	-	-	-	13MoCrV6	-
	50CrVA	50CrV4	1.8159	6150	735A50	47	50CV4	2230	50CrV4	51CrV4	SUP10
	-	41CrAlMo7	1.8509	-	905M39	41B	40CAD6,12	2940	41CrAlMo7	41CrAlMo7	-
	-	39CrMoV139	1.8523	-	897M39	40C	-	-	36CrMoV12	-	-

Material Conversion Table

ISO	Country and standard										
	China	International	Germany	U.S.A.	U.K.		France	Sweden	Italy	Spain	Japan
	GB	DIN	W.-nr	AISI/SAE	BS	EN	AFNOR	SS	UNI	UNE	JIS
P	Tool steel										
	T10	C105W1	1.1545	W.110	-	-	Y1105	1880	C98KU C100KU	F.515 F.516	-
	T12A	C125W	1.1663	W.112	-	-	Y2120	-	C120KU	(C120)	SK20
	GCr15	100Cr6	1.2067	L3	BL3	-	Y100C6	-	-	100Cr6	-
	Cr12	X210Cr12	1.2080	D3	BD3	-	Z200Cr12	-	X210Cr13KU X250Cr12KU	X210Cr12	SKD1
	4Cr5MoVSi	X40CrMoV5 1	1.2344	H13	BH13	-	Z40CDV5	2242	X35CrMoV05KU X40CrMoV51KU	X40CrMoV5	SKD61
	Cr6WV	X100CrMoV5 1	1.2363	A2	BA2	-	Z100CDV5	2260	X100CrMoV51KU	X100CrMoV5	SKD12
	CrWMo	105WCr6	1.2419	-	-	-	105WC13	2140	10WCr6 107WCr5KU	105WCr5	SKS31 SKS2 SKS3
	Cr12W	X210CrW12	1.2436	-	-	-	-	2312	X215CrW12 1KU	X210CrW12	SKD2
	5CrNiMo	45WCrV7	1.2542	S1	BS1	-	-	2710	45WCrV8KU	45WCrSi8	-
	3Cr2W8V	X30WCrV93 X30WCrV93KU	1.2581	H21	BH21	-	Z30WCV9	-	X28W09KU X30WCrV9 3KU	X30WCrV9	SKD5
	Cr12MoV	X165CrMoV 12	1.2601	-	-	-	-	2310	X165CrMoW12KU	X160CrMoV12	SKD11
	5CrNiMo	55NiCrMoV6	1.2713	L6	-	-	55NCDV7	-	-	F.250.S	SKT4
	V	100V1	1.2833	W210	BW2	-	Y1105V	-	-	-	SKS43
	W6Mo5Cr4V2Co5	S6-5-2-5	1.3243	-	-	-	Z85WDCV	2723	HS6-5-2-5	HS6-5-2-5	SKH55
	W18Cr4VCo5	S18-1-2-5	1.3255	T4	BT4	-	Z80WKC 10-05-04-01	-	X78WCo1805KU	HS18-1-1-5	SKH3
	W6Mo5Cr4V2	S6-5-2	1.3343	M2	BM2	-	Z85WDCV 06-05-04-02	2722	X82WMo0605KU	HS6-5-2	SKH9
	-	S2-9-2	1.3348	M7	-	- Z -	Z100WCWV 09-02-04-02	2782	HS2-9-2	HS2-9-2	-
	W18Cr4V	S18-0-1	1.3355	T1	BT1	-	Z80WCV 18-04-01	-	X75W18KU	HS18-0-1	SKH2
	W6Mo5Cr4V3	S6-5-3	-	M3	-	-	-	-	-	-	SKH52
-	-	-	M42	BM42	-	-	-	-	-	SKH59	

Material Conversion Table

ISO	Country and standard										
	China	International	Germany	U.S.A.	U.K.		France	Sweden	Italy	Spain	Japan
	GB	DIN	W.-nr	AISI/SAE	BS	EN	AFNOR	SS	UNI	UNE	JIS
M	Stainless steel										
	0Cr13; 1Cr12	403	1.4000	403	403S17	-	Z6C13	2301	X6Cr13	F.3110	SUS403
	-	-	1.4001	-	-	-	-	-	-	F.8401	-
	1Cr13	410	1.4006	410	410S21	56A	X12Cr13	2302	X12Cr13	F.3401	SUS410
	1Cr17	430	1.4016	430	430S15	60	X8Cr17	220	X8Cr17	F.3113	SUS430
	2Cr13	410	1.4021	40	S62	56B;56C	X20C13	-	X20C13	F.3401	SUS410
	-	-	1.4027	-	420C29	56B	-	-	-	-	SCS2
	4Cr13	-	1.4034	-	420S45	56D	X40Cr14	2304	X40Cr14	F.3405	SUS420J2
	1Cr17Ni2	431	1.4057	431	431S29	57	X16CrNi16	2321	X16CrNi16	F.3427	SUS431
	Y1Cr17	430F	1.4104	430F	-	-	X10CrS17	2383	X10CrS17	F.3117	SUS430F
	1Cr17Mo	434	1.4113	434	434S17	-	X8CrMo17	2325	X8CrMo17	-	SUS434
	-	-	1.4313	-	425C11	-	-	-	-	-	SCS5
	-	-	1.4408	-	316C16	-	-	-	-	F.8414	SCS14
	4Cr9Si2	HW3	1.4718	HW3	401S45	52	X45CrSi8	-	X45CrSi8	F.322	SUH1
	0Cr13Al	405	1.4724	405	403S17	-	X10CrAl12	-	X10CrAl12	F.311	SUS405
	Cr17	430	1.4742	430	430S15	60	X8Cr17	-	X8Cr17	F.3113	SUS430
	8Cr20Si2Ni	HNV6	1.4757	HNV6	443S65	59	X80CrSiNi20	-	X80CrSiNi20	F.320V	SUH4
	2Cr25N	446	1.4762	446	-	-	X16Cr26	2322	X16Cr26	-	SUH446
	Austenitic stainless steel										
	0Cr18Ni9	X5CrNi1810	1.4301	304	304S15	58E	Z6CN18.09	2332	X5CrNi1810	F.3551; F.3541; F.3504	SUS304
	1Cr18Ni9MoZr	X10CrNiS189	1.4305	303	303S21	58M	Z10CNF18.09	2346	X10CrNiS18.09	F.3508	SUS303
	0Cr19Ni10	X2CrNi1911	1.4306	304L	304S12	-	Z2CN18.10	2352	X2CrNi18.11	F.3503	SCS19
	-	G-X6CrNi189	1.4308	-	304C15	-	Z6CN18.10M	-	-	-	SCS13
	Cr17Ni17	X12CrNi177	1.4310	301	-	-	Z12CN17.07	2331	X12CrNi1707	F.3517	SUS301
	-	X2CrNi1810	1.4311	304LN	304S62	-	Z2CN18.10	2371	-	-	SUS304LN
	0Cr19Ni9	X5CrNi189	1.4350	304	304S31	58E	Z6CN18.09	-	X5CrNi1810	-	SUS304
	0Cr17Ni11Mo2	X5CrNiMo1712	1.4401	316	316S16	Z6CND 17.11	1.4401	2347	X5CrNiMo1712	F.3543	SUS316
	00Cr17Ni13Mo2	X2CrNiMo17133	1.4429	316LN	-	-	Z2CND17.13	2375	-	-	SUS316LN
	0Cr27Ni12Mo3	X2CrNiMo18143	1.4435	316L	316S12	-	Z2CDN17.13	2353	X2CrNiMo1713	-	SCS16
	00Cr19Ni13Mo3	X2CrNiMo17133	1.4438	317L	317S12	-	Z2CND19.15	2367	X2CrNiMo18.16	-	SUS317L
-	X8CrNiMo275	1.4460	329L	-	-	-	2324	-	-	SUS329L; SCH11; SCS11	

Material Conversion Table

ISO	Country and standard										
	China	International	Germany	U.S.A.	U.K.		France	Sweden	Italy	Spain	Japan
	GB	DIN	W.-nr	AISI/SAE	BS	EN	AFNOR	SS	UNI	UNE	JIS
M	Austenitic stainless steel										
	1Cr18Ni9Ti	X6CrNiTi1810	1.4541	321	2337	321S12	Z6CNT18.10	58B	X6CrNiTi1811	F.3553	SUS321
	1Cr18Ni11Nb	X6CrNiNb1810	1.4550	347	347S17	58F	Z6CNNb18.1	2338	X6CrNiTi1811	F.3552	SUS347
	Cr18Ni12Mo2Ti	X6CrNiMoTi17122	1.4571	316Ti	320S17	58J	Z6NDT17.12	2350	X6CrNiMoTi17	F.3535	-
	-	G-X5CrNiMoNb1810	1.4581	-	318C7	-	Z4CNDNb1812M	-	XG8CrNiMo18	-	SCS22
	Cr17Ni12Mo3Nb	X10CrNiMoNb1812	1.4583	318	-	-	Z6CNDNb1713B	-	X6CrNiMoTiNb17	-	-
	1Cr23Ni13	X15CrNiSi2012	1.4828	309	309S24	-	Z15CNS20.1	-	-	-	SUH309
	0Cr25Ni20	X12CrNi2521	1.4845	310S	310S24	-	Z12CN2520	2361	X6CrNi2520	F.331	SUH310
	Cr15Ni36W3Ti	X12NiCrSi3616	1.4864	330	-	-	Z12CNS35.1	-	-	-	SUH330
	-	G-X40NiCrSi3818	1.4865	-	330C11	-	-	-	XG50NiCr3919	-	SCH15
	5Cr2Mn9Ni4N	X53CrMnNiN219	1.4871	EV8	349S54; 321S12	- 58B	Z52CMN21.0	-	X53CrMnNiN219	-	SUH35
1Cr18Ni9Ti	X12CrNiTi189	1.4878	321	321S320	58C	Z6CNT18.12	-	X6CrNiTi1811	F.3523	SU321	

ISO	Country and standard								
	China	Germany	U.S.A.	U.K.	France	Sweden	Italy	Spain	Japan
	GB	W.-nr	AISI/SAE	EN	AFNOR	SS	UNI	UNE	JIS
K	Nodular cast iron								
	QT400-18	GGG40	60-40-18	400/17	FGS370-17	0717-02	GS370-17	FGE38-17	FCD400
	QT450-10	--	65-45-12	420/12	FGS400-12	--	GS400-12	FGE42-12	FCD450
	QT500-7	GGG50	70-50-05	500/7	FGS500-7	0727-02	GS500-7	FGE50-7	FCD500
	QT600-3	GGG60	80-60-03	600/7	FGS600-2	0732-03	GS600-2	FGE60-2	FCD600
	QT700-2	GGG70	100-70-03	700/2	FGS700-2	0737-01	GS700-2	FGE70-2	FCD700
	QT800-2	GGG80	120-90-02	800/2	FGS800-2	0864-03	GS800-2	FGE80-2	FCD800
	QT900-2	--	--	900/2	--	--	--	--	--
	Grey cast iron								
	--	GG40	NO.60	--	FGL400	0140	--	--	--
	HT350	GG35	NO.50	350	FGL350	0135	G35	FG35	FC350
	HT300	GG30	NO.45	300	FGL300	0130	G30	FG30	FC300
	HT250	GG25	NO.35	250	FGL250	0125	G25	FG25	FC250
	HT200	GG20	NO.30	200	FGL200	0120	G20	FG20	FC200
	HT150	GG15	NO.20	150	FGL150	0115	G15	FG15	FC150
	HT100	--	--	100	--	0110	G10	--	FC100

Material Conversion Table

ISO	Country and standard									
	China	International	Germany	U.S.A.	U.K.	France	Sweden	Italy	Spain	Japan
	GB	DIN	W.-nr	AISI/SAE	BS	AFNOR	SS	UNI	UNE	JIS
N	Al-based alloy									
	ZAlSi7Mg	Al-Si7Mg(Fe)	~AlSi7Mg	356	LM25	A-S7G	4244	3599	-	AC4C
	ZAlSi7MgA	Al-Si7Mg	AlSi7Mg	A356.0	2L99	A-S7G03	-	8024	-	AC4C
	ZAlSi12	Al-Si12	AlSi12	413;B413.0	LM6	A-S13	4261	4514	-	AC3A
	ZAlSi9Mg	~Al-Si10Mg	AlSi9Mg	360	LM9	A-S9G;A-S10G	4253	3051	-	AC4A
	-	Al-Si5	AlSi5Mg	A 443.0	-	-	-	5077	-	-
	-	Al-Si5Fe	-	B443.0	-	-	-	GD-AlSi5Fe	-	-
	-	(AlSi7Fe)	-	A444.0	-	-	-	-	-	-
-	Al-Si12Fe	-	413	LM20	~A-S12	4260	5079	-	ADC1	

ISO	Country and standard									
	China	International	Germany	U.S.A.	U.K.	France	Sweden	Italy	Spain	Japan
	GB	DIN	W.-nr	AISI/SAE	BS	AFNOR	SS	UNI	UNE	JIS
S	Ni-based alloy									
	-	S-NiCr13A16MoNb	LW2 4670	5391	mar - 46	NC12AD	-	-	-	-
	-	NiCo15Cr10MoAlTi	LW2 4674	AMS 5397	-	-	-	-	-	-
	-	NiFe35Cr14MoTi	LW2.4662	5660	-	ZSNCDT42	-	-	-	-
	-	NiCr19Fe19NbMo	LW2.4668	5383	HR8	NC19eNB	-	-	-	-
	-	NiCr20TiAk	2.4631	-	Hr401.601	NC20TA	-	-	-	-
	-	NiCr19Co11MoTi	2.4973	AMS 5399	-	NC19KDT	-	-	-	-
	-	NiCr19Fe19NbMo	LW2.4668	AMS 5544	-	NC20K14	-	-	-	-
	-	-	2.4603	5390A	-	NC22FeD	-	-	-	-
	-	NiCr22Mo9Nb	2.4856	5666	-	NC22FeDNB	-	-	-	-
	-	NiCr20Ti	2.4630	-	HR5.203-4	NC20T	-	-	-	-
	-	NiCu30AL3Ti	2.4375	4676	3072-76	-	-	-	-	-
	Co-based alloy									
	-	CoCr20W15Ni	-	5537C,AMS	-	KC20WN	-	-	-	-
	-	CoCr22W14Ni	LW2.4964	5772	-	KC22WN	-	-	-	-
	Ti-alloy									
	-	TiAl5Sn2.5	3.7115.1	UNS R54520	TA14/17	T-A5E	-	-	-	-
	-	-	-	-	-	UNS R56400	-	-	-	-
	-	TiAl6V4	3.7165.1	-	TA10-13/ TA28	UNS R56401	-	T-A6V	-	-
	-	TiAl5V5Mo5Cr3	-	-	-	-	-	-	-	-
-	TiAl4Mo4Sn4Si0.5	3.7185	-	-	-	-	-	-	-	

Product	Page	Product	Page	Product	Page	Product	Page
A		ASIBR/L	135	BT50-FM□□-□	441	CPMT-PB1	71
ABF	129	ASIFR/L	144	BT50-FM□□-□-C	442	CPMT-PC2	71
ACD - CH	181	ASIGR/L	139	BT50-FMD□-□	444	CT-HSK100	455
ACD - CM	180	ASITR/L	145	BT50-PC□-□	436	CT-HSK63	455
ACD - CS	179	ASM90-AO12	242	BT50-SLB□-□	445		
ADMT 11T3	298	ASM90-AP17	238	C		D	
AFB-A/B/C□□	391	ASM90-LN09	228	C□□-□□	446	D106-03A0	399
AFB-AK□	374	ASM90-LN12	226	C□C-M□-□□-R	458	D106-03A1	407
AFF40-LN12	224	ASM90-LN13	230	C□C-M□-□□-T	457	D106-05A0	403
AFF40-LN15	224	ASM90-LN16	232	C□S-M□-□□-T	456	D106-05A1	411
AFM40-ON05	204	ASM90-TD15	240	CCET-FL-F	72, 73	D108-08A1	415
AFM42-OD06	202	ASM90-WN08	234	CCET-FL-M	73	DCET-FL-F	76
AFM45-SD09	206	ASM90-WN08-N	236	CCET-FR-F	72, 73	DCET-FL-M	77
AFM45-SD12	210	ASWB	133	CCET-FR-M	73	DCET-FR-F	76
AFM45-SN12	214	ASWP	131	CCGT-E-UF	70	DCET-FR-M	77
AFM45-SN19	214	ASWSR/L	130	CCGT-FP-LF	70	DCGT-E-UF	74
AFM45-XN07	220	ASWT	133	CCGT-FP-UF	70	DCGT-FP-LF	74
AFM45-XN09	222	ATBD	188	CCGT-F-UF	70	DCGT-FP-UF	74
AFM75-SN12	216	ATD - E	187	CCGT-NC2	71	DCGT-F-UF	74
AFM88-SN12	218	ATD - E-G	186	CCGW-1-LL-07	108	DCGT-NC2	75
AFM90-SD09	208	ATD - E-GS	182	CCGW-1-NL-00	108	DCGW-1-NL-00	109
AFM90-SD12	212	ATD - RA	184	CCGW-1-NL-05	108	DCGW-1-NL-05	109
AGPFR/L	164	ATD - RM	184	CCGW-SL-1	100	DCGW-SL-1	101
AGSFR/L	163	ATD - TM	183	CCGW-SL-2	100	DCGW-SL-2	101
AGSIR/L	169	ATD - TS	183	CCMT-F1T	71	DCMT-F1T	75
AGUER/L	159	ATG 32	177	CCMT-KC2	72	DCMT-KC2	75
AGUIR/L	170	ATG 43	178	CCMT-M2T	72	DCMT-PB1	75
AHM15-XD09	252	ATGHR/L	153	CCMT-PB1	71	DCMT-PC2	75
AHM15-XD12	254	ATGIR/L	167	CCMT-PC2	71	DCMW-KD5	76
AHM20-LN06	248	ATM60	426	CCMW-KD5	72	DFB-□□-BBT50-□	378
AHM25-LN10	250	ATPFR/L	165	CNGA-1-NL-00	106	DNGA-1-NL-00	106
AK-□□-□□	384	ATPIR/L	166	CNGA-SL-1	94	DNGA-SL-1	95
AOMT 1204	297	ATSER/L	155	CNGA-SL-2	94	DNGA-SL-2	95
APE90-LN09	244	ATSER/L-D	157	CNGA-SL-4	94	DNGA-SL-4	95
APE90-LN13	246	ATSER/L-SW	158	CNMA-KD5	52	DNMA-KD5	56
APHT-P-DH	361	ATSFR/L	160	CNMG-KC4	52	DNMG-BS	54
APHT-P-DL	362	ATSFR/L-OB	161	CNMG-MB2	50	DNMG-KC4	56
APKT 1003	296	ATSIR/L	168	CNMG-MC3	51	DNMG-M1T	54
APKT 1705	295			CNMG-MC4	51	DNMG-MB2	54
APM00-RO08	258	B		CNMG-PB1	50	DNMG-MC3	55
APM00-RO10	260	BAR□□-□	379	CNMG-PB3	50	DNMG-MC4	56
APM00-RO12	262	BS-□□	373	CNMG-PC3	50	DNMG-PB1	54
APM00-RO16	264	BS-□□-LD	373	CNMG-PC4	51	DNMG-PB3	54
APM00-RO20	266	BT40-AK□-□	381	CNMG-PD3	50	DNMG-PC3	55
APM00-RP080	256	BT40-ER□-□	437	CNMG-PD5	52	DNMG-PC4	56
APM00-RP100	256	BT40-FM□□-□	439	CNMG-SC1	50	DNMG-PD3	55
APMT 1135	299	BT40-FM□□-□-C	440	CNMG-SC3	51	DNMG-PD5	56
APMT 1604	299	BT40-PC□-□	436	CNMG-SL3	50	DNMG-PL5	55
APMT-DH	363	BT40-SLB□-□	445	CNMM-PC8	53	DNMG-SC1	54
ARB-AK□	370	BT50-AK□-□	381	CNMM-PC9	53	DNMG-SC3	55
ASG 32	176	BT50-BA40-□	383	CNMM-PD8	53	DNMG-SL3	54
ASGHR/L	151	BT50-ER□-□	437	CNMM-PD9	53		
ASI	134						

Product	Page	Product	Page	Product	Page	Product	Page
E		M121-4CS	323	SCMT-PB1	78	TCET-FR-M	83
EFB-□□-AK□	380	M121-4CSP	323	SCMT-PC2	78	TCGT-E-UF	79
EPMT-C-DH	361	M121-4ESP	324	SCMW-KD5	78	TCGT-FP-LF	79
EPMT-I-DH	361	M125-6ES	325	SDGT	279	TCGT-FP-UF	79
EPMT-I-DL	362	M145-2ES	316	SDJCR/L	117	TCGT-F-UF	79
ER□□-□	448	M145-3EL	317	SDKT	279	TCGT-NC2	79
ER□□-□A	449	M145-3ES	317	SDLCR/L	118	TCGW-1-NL-00	110
ER□□-□C	450	MLF-□-□	376	SDMT	279	TCGW-1-NL-05	110
ER□□-□CA	451	MLF-□-□LD	376	SDNCN	118	TCMT-KC2	81
ER□□-□W□	452	MLR-□-□	373	SEKT	280	TCMT-M2T	81
ER□□-UM	453	MLR-□-□LD	373	SFB-□-AK6	379	TCMT-PB1	80
F		O		SNGA-SL-1	96	TCMT-PC2	80
FCC-□□	375	ODET	277	SNGA-SL-4	96	TCMW-KD5	81
FCT-□□	375	ODEW	277	SNGA-SL-8	96	TDHT 1505	292
G		ODHT	277	SNGX	281	TDMT 1505	292
GPAD	364	ODMT	277	SNHX	281	TM55G	427
H		ONHF	288	SNMA-KD5	59	TM60G	427
HP-2D(SPMT)	346	ONHU	278	SNMG-KC4	58	TNGA -SL-1	97
HP-3D(SPMT)	348	ONMU	278	SNMG-M3T	57	TNGA -SL-3	97
HP-4D(SPMT)	350			SNMG-MB2	57	TNGA -SL-6	97
HSK-A100-AK□-□	382	R		SNMG-MC3	57	TNGA-1-NL-00	107
HSK-A100-BA40-□	383	RC-□-CC□	371	SNMG-MC4	58	TNGG-FL-F	62
HSK-A63-AK□-□	382	RC-□-CC□-B	372	SNMG-PB1	57	TNGG-FP-UF	62
L		RC-□-SC□	371	SNMG-PC3	57	TNGG-FR-F	62
LNET	287	RCGT-NC2	90	SNMG-PC4	58	TNGG-L-H	62
LNHQ	288	RCMX	90	SNMG-PD3	57	TNGG-R-H	62
LNHU 0904	289	RCMX-PD8	90	SNMG-PD5	58	TNMA-KD5	62
LNHU 1306	290	RDHT	304	SNMG-SC3	57	TNMG-KC4	61
LNHU 1607	291	RDHW	304	SNMG-SL3	57	TNMG-M1T	60
LNMX	300	RDMT	304	SNMM-PC9	59	TNMG-M2T	60
LNMX-AM	69	RDMW	304	SNMM-PD8	59	TNMG-MB2	60
LNMX-AR	69	ROHT	305	SNMM-PD9	59	TNMG-MC3	61
LNMX-AS	69	ROMT	305	SNMX	281	TNMG-MC4	61
LNMX-HE	68	RPM 080ER	303	SNMX-PD9	59	TNMG-PB1	60
M		RPM 100ER	303	SPMT-DP	356	TNMG-PB3	60
M100-2BS	313	RPMT	304	STGCR/L	119	TNMG-PC3	60
M100-2ES	311	RPMW	304	STGPR/L	119	TNMG-PC4	61
M100-4EL	312	S□□□-ASGHL	152	SVJBR/L	120	TNMG-PD3	60
M100-4ES	312	S□□□R/L□CA-□	386	SVJCR/L	122	TNMG-PD5	61
M100-4RL	314	S□□□-SCLCL	126	SVLPR/L	123	TNMG-PL5	60
M105-6EL	315	S□□□-SDUCL	127	SVPBR/L	121	TNMG-SC3	60
M105-6ES	315	S□□□-SVUBL	128	SVPPR/L	123	TNMM-PD8	62
M110-2BS	320	S□□□-SVUPL	128	SVVBN	121	TPEH-FL-F	82, 83
M110-2ES	318	SCGT-NC2	78	SVVCN	122	TPEH-FR-F	82, 83
M110-4ES	319	SCGW-1-LL-07	109			TPGW-1-LL-07	110
M115-6ES	321	SCLCR/L	116	T		TPGW-1-NL-00	110
M116-4PS	322	SCMT-HT	78	TBET-FL-F	81	TPGW-1-NL-05	110
		SCMT-KC2	78	TBET-FR-F	81	TPGW-SL-1	102
		SCMT-M2T	78	TBGW-1-NL-05	110	TPGW-SL-3	102
				TCET-FL-F	82	TPMT-DH	363
				TCET-FL-M	83	TPMT-PC2	80
				TCET-FR-F	82	TPMX-DH	364

Product	Page	Product	Page	Product	Page	Product	Page
V		VPGT-F-UF	85				
VBET-FL-F	86	VPGT-NC2	85				
VBET-FL-M	87						
VBET-FL-Y	88						
VBET-FR-F	86	W					
VBET-FR-M	87	WBET-FL-F	89				
VBET-FR-Y	88	WBET-FR-F	89				
VBGT-E-UF	84	WCMT(DU)	356				
VBGT-FP-LF	84	WNGA -SL-1	99				
VBGT-FP-UF	84	WNGA -SL-3	99				
VBGT-F-UF	84	WNGA -SL-6	99				
VBGW -SL-1	103	WNGU 0806	293				
VBGW -SL-2	103	WNMA-KD5	67				
VBGW-1-NL-05	111	WNMG-F1T	65				
VBMT-BS	85	WNMG-KC4	67				
VBMT-KC2	86	WNMG-M3T	66				
VBMT-PB1	86	WNMG-MB2	65				
VBMT-PC2	86	WNMG-MC3	66				
VCET-FL-F	87	WNMG-MC4	67				
VCET-FR-F	87	WNMG-PB1	65				
VCGT-E-UF	85	WNMG-PB3	65				
VCGT-FP-LF	84	WNMG-PC3	65				
VCGT-FP-UF	85	WNMG-PC4	66				
VCGT-F-UF	85	WNMG-PD3	66				
VCGT-NC2	85	WNMG-PD5	67				
VCGW -SL-1	103	WNMG-PL5	66				
VCGW -SL-2	103	WNMG-SC1	65				
VCGW-1-NL-05	111	WNMG-SC3	66				
VCMT-PB1	86	WNMG-SL3	65				
VCMT-PC2	86	WNMU 0806	294				
VNGA -SL-1	98						
VNGA -SL-2	98						
VNGA -SL-4	98	X					
VNGA-1-NL-00	107	XDLT	302				
VNGG-FP-UF	64	XDMW	302				
VNMG-BS	63	XNGU	285				
VNMG-KC4	64	XNGX	286				
VNMG-M3T	64	XNMU	285				
VNMG-MB2	63						
VNMG-MC3	64						
VNMG-PB1	63						
VNMG-PB3	63						
VNMG-PC3	63						
VNMG-PC4	64						
VNMG-PD3	64						
VNMG-SC3	64						
VNMG-SL3	63						
VPET-FL-F	87						
VPET-FL-M	88						
VPET-FR-F	87						
VPET-FR-M	88						
VPGT-FP-LF	84						
VPGT-FP-UF	85						

